

COUNCIL MEETING AGENDA

Casper City Council
City Hall, Council Chambers
Tuesday, October 4, 2022, 6:00 p.m.



COUNCIL POLICY PUBLIC STATEMENTS

- I. Members of the Public Wishing to Speak to an Item Already on the Agenda, Other Than a Public Hearing, or Second or Third Reading Ordinance, Must Submit a Request to the City Clerk's Office by 12:00 Noon on the Monday Immediately Preceding the Council Meeting, or May Speak During the Communications from Persons Present.
- II. When Speaking to the City Council Please:
 - Clearly State Your Name and Address.
 - Direct all questions/comments to the Mayor and only the Mayor.
 - No personal attacks on staff or Council.
 - Speak to the City Council with Civility and Decorum.
- III. The City Council Will Not Respond to Any Comments or Questions Concerning Personnel Matters. Any Such Comments or Questions Will be Handled by the Appropriate Persons. Public Hearing Comments and Presentations Will be Limited to Five Minutes or Less per Person, nor Will Time Extensions be Permitted. No Duplication of Speakers will be Allowed.
- IV. Questions Posed by Speakers May, or May Not be Responded to by Council Members.
- V. Willful Disruption of, or the Breach of the Peace at, a Council Meeting may Result in the Removal of any Such Individuals or Groups from the Council Chambers.
(These Guidelines Are Also Posted at the Podium in the Council Chambers)

Please silence cell phones during the City Council meeting.

Entrance to the meetings is the east door off David Street. Face coverings are encouraged for those individuals who have not been fully vaccinated against COVID-19. Public input via email is encouraged: CouncilComments@casperwy.gov

AGENDA

1. ROLL CALL
2. PLEDGE OF ALLEGIANCE
3. APPROVAL OF COUNCIL MEETING MINUTES

We are CASPER

Communication Accountability Stewardship Professionalism Efficiency Responsiveness

- A. CONSIDERATION OF MINUTES OF THE SEPTEMBER 20, 2022 REGULAR COUNCIL MEETING, AS PUBLISHED IN THE CASPER STAR-TRIBUNE ON SEPTEMBER 30, 2022
- B. CONSIDERATION OF MINUTES OF THE SEPTEMBER 20, 2022 EXECUTIVE SESSION
- 4. CONSIDERATION OF BILLS AND CLAIMS
- 5. BRIGHT SPOT: FIRE PREVENTION WEEK 2022
- 6. COMMUNICATIONS
 - A. From Persons Present
- 7. ESTABLISH DATES OF PUBLIC HEARINGS
 - A. Consent
 - 1. Establish October 18, 2022, as the Public Hearing Date for Consideration of:
 - a. An Ordinance Repealing and Replacing Ordinance No. 16-97 Codified as Chapter 8.08, **Private Intrusion Alarms**, of the Casper Municipal Code.
- 8. PUBLIC HEARINGS
 - A. Minute Action
 - A. **New Restaurant Liquor License No. 48** for Blues Gypsy, LLC, dba the **Bluebird at the Cheese Barrel**, Located at 544 South Center.
- 9. SECOND READING ORDINANCE
 - A. Ordinance Approving a Partial Plat, Vacation, Replat, Vacation of Public Parkland and a Zone Change for the **North Platte River Park No. 2 Subdivision**.
 - B. An **Annexation of 2.0-Acres Described as Tract 8, Dowler No. 2 Subdivision** (3025 Paradise Drive), Establishing the Zoning of Said Parcel as C-2 (General Business), and **Rezoning 8.2-acres Described as the Paradise Acres Addition** (3041 Paradise Drive) as C-2 (General Business)
- 10. THIRD READING ORDINANCE
 - A. Correcting a **Scrivener's Error** in the Legal Description of Ordinance No. 34-19 Pertaining to the Mistaken Inclusion, Via Annexation, of the West Half of Lots 26 & 27, **South Garden Creek Acres No. 2 Addition** in the Casper Municipal Limits.
 - 1. Communications from Persons Present

We are **CASPER**

Communication Accountability Stewardship Professionalism Efficiency Responsiveness

11. RESOLUTIONS

A. Consent

1. Authorizing a Contract for Professional Services with **Automation & Electronics, Inc.**, for the **Casper Regional Landfill Cell 5 Leachate Controls**, Project No. 21-012B.
2. Authorizing a Contract for Professional Services with **Long Building Technologies, Inc.**, for Construction Services for the **Ford Wyoming Center Flue Replacement**, Project No. 22-058.
3. Authorizing the Execution of a License Agreement with the **Natrona County Board of County Commissioners** for **Sanitary Sewer Main Work**.
4. Approving Amendment No. 1 to the Contract for Professional Services with **Dynamic Controls Incorporated** for Installation and Programming of Access Control on Select **Doors at the Ford Wyoming Center**.
5. Authorizing **the Release of a Local Assessment District Lien**, LAD 156, Regarding **1818 Fetterman Ave**, Casper, Wyoming.
6. Authorizing the **Partial Release of a Local Assessment District Lien**, LAD 153, Regarding **1517 Fremont Ave**.
7. Authorizing a Memorandum of Understanding Concerning **Metro Animal Shelter Services** between **City of Mills**, Wyoming, and the City of Casper, Wyoming.
8. Establishing a Memorandum of Understanding Between the City of Casper and **Natrona County Public Library** for a **StoryWalk**.
9. Authorizing a **Ground Lease Agreement** between the City of Casper and **WYO Complex**, a Wyoming Non-Profit Corporation.
10. Authorizing a **Right-of-Way Easement** with Rocky Mountain Power for the **Natrona County School District Tennis Facility**.

12. MINUTE ACTION

A. Non-Consent

1. Authorizing the **Purchase of One (1) Lenco BearCat Armored Tactical Rescue Vehicle** in the Amount of \$168,872.00

B. Consent

1. **Appointments to the Council Boards and Commissions** to Fill Vacancies Left by Councilmembers' Resignations.

We are **CASPER**

Communication Accountability Stewardship Professionalism Efficiency Responsiveness

13. INTRODUCTION OF MEASURES AND PROPOSALS BY MEMBERS OF THE CITY COUNCIL

14. ADJOURN INTO EXECUTIVE SESSION – PERSONNEL & LITIGATION

15. ADJOURNMENT OF REGULAR MEETING

Upcoming Council Meetings

Regular Council Meetings

6:00 p.m. Tuesday, October 18, 2022 – Council Chambers

6:00 p.m. Tuesday, November 1, 2022 – Council Chambers

Work Sessions

4:30 p.m. Tuesday, October 11, 2022 – Council Meeting Room

4:30 p.m. Tuesday, October 25, 2022 – Council Meeting Room

ZONING CLASSIFICATIONS

FC	Major Flood Channels & Riverbanks	PUD	Planned Unit Development
AG	Urban Agriculture	HM	Hospital Medical
R-1	Residential Estate	C-1	Neighborhood Convenience
R-2	One Unit Residential	C-2	General Business
R-3	One to Four Unit Residential	C-3	Central Business
R-4	High-Density Residential	C-4	Highway Business
R-5	Mixed Residential	M-1	Limited Industrial
R-6	Manufactured Home (Mobile) Park	M-2	General Industrial
PH	Park Historic	SMO	Soil Management Overlay

We are **CASPER**

Communication Accountability Stewardship Professionalism Efficiency Responsiveness

COUNCIL PROCEEDINGS
Casper City Hall – Council Chambers
September 20, 2022

1. ROLL CALL

Casper City Council met in regular session at 6:00 p.m., Tuesday, September 20, 2022. Present: Councilmembers McIntosh, Sutherland, Gamroth, Engebretsen, Knell, Cathey, Pollock, and Pacheco. Councilmember Humphrey joined the meeting virtually.

2. PLEDGE OF ALLEGIANCE

Mayor Pacheco welcomed members of the Boy Scouts to lead the audience in the pledge of allegiance.

3.A. REGULAR MEETING MINUTES

Moved by Vice Mayor Knell, seconded by Councilmember Pollock to, by minute action, approve the minutes of the September 6, 2022 regular Council meeting, as published in the Casper Star Tribune on September 18, 2022. Motion passed.

3.B. EXECUTIVE SESSION MINUTES

Moved by Councilmember Engebretsen, seconded by Councilmember Gamroth to, by minute action, approve the minutes of the first September 6, 2022 Executive Session regarding personnel. Motion passed.

3.C. EXECUTIVE SESSION MINUTES

Moved by Councilmember Pollock, seconded by Councilmember Engebretsen to, by minute action, approve the minutes of the second September 6, 2022 Executive Session regarding personnel, litigation, and land acquisition. Motion passed.

4. BILLS & CLAIMS

Moved by Councilmember Engebretsen, seconded by Councilmember Gamroth to, by minute action, approve payment of the September 20, 2022, bills and claims, as audited by City Manager Napier. Motion passed.

<u>Bills & Claims 09/20/22</u>		
71Const	Goods	775.50
AAALndscpng	Services	959.01
AceHrdwr	Goods	191.64
ACZLbrtrs	Services	954.50
Airgas	Goods	254.14
AllenInspctns	Services	7,440.00
AllTrees	Services	750.00
Alsco	Services	1,884.03
AMBI	Services	844.64
Amrgs	Goods	208.89
AquaSmrt	Goods	135,600.00
ArrwheadHeat	Services	281.75

AT&T	Services	32,645.16
Atlas	Goods	2,841.39
BKegler	Reimb	150.00
BdgrMtr	Services	163.76
BigHrnTire	Services	355.00
BlkHillsEnrgy	Utilities	1,152.81
BrntagPac	Goods	138,037.70
Brian'sGoTo	Services	1,391.07
BrbcksRfrgrtn	Services	5,785.33
CLuse	Services	1,225.00
CRiley	Reimb	587.58
CSimons	Reimb	123.13
C&CSply	Goods	79.83
Caselle	Services	78.00
CsprAreaCnvntn	Services	27.00
CsprCollege	Services	390.00
CsprStrTrb	Services	2,164.20
CsprTinShop	Services	7,273.70
CsprTire	Services	180.00
CsprVtrnry	Services	1,219.70
CsprWndw&Door	Services	807.50
CWRWS	Goods	1,430,805.58
CntrlWyoRescueMission	Services	7,290.25
CntryLnk	Utilities	14,954.99
CrtfdBusSrvc	Goods	23,907.00
ChlkButtesLndscpng	Services	96,600.95
CitrixSystms	Services	8,440.50
CtyCspr	Services	312,106.50
CtyPrkChrch	Refund	580.00
CivicPlus	Goods	900.00
CivilEngnrng	Services	14,414.99
CMITeco	Services	10,904.63
CoastlChmcl	Goods	136.34
CocaCola	Services	24.75
Cmtrnx	Goods	3,196.70
Cnvrng	Goods	39,914.50
Cordico	Services	27,000.00

Core&Main	Goods	8,395.64
CowboySplyHse	Goods	368.65
CPU	Goods	10,074.88
CrumElctrcSply	Goods	23.85
CVIC	Services	1,641.13
DRodrick	Refund	831.34
DKpnr	Services	725.10
Datamrs	Services	2,900.00
DvdsnMchncl	Services	72,775.00
DPCIndstrs	Goods	45,951.23
DynmcCntrl	Services	767.52
EnrgyLabs	Services	999.00
EngnrngDsgn	Services	1,750.00
ExpSvcs	Services	1,971.42
FaroTchnlgs	Goods	5,814.25
FrgsnEnt	Goods	28.20
FIB	Goods/Invstmnts	18,036.18
FoxstrOpco	Goods	700.00
FrmntMtr	Goods/Services	48,746.90
Galls	Goods	1,408.12
GameTime	Goods	1,753.36
GloblSpctrm	Services	107,506.68
GldrAssoc	Services	3,004.00
Gnrg	Goods	238.28
GnrMotr	Goods	70,860.00
Hach	Goods	8,825.60
HrvrdDrugGrp	Goods	727.16
HzrdCntrlTchnlgs	Goods	1,080.00
HDREngnrng	Services	9,007.50
Homax	Goods	39,143.74
Hose&RubrSply	Goods	515.61
HowrdSply	Goods	258.20
IME	Services	1,642.50
IntgrtdTchnlgs	Services	300.00
ITCElctrel	Services	1,308.60
JCarpenter	Reimb	30.00
JCKirk	Reimb	120.00

JGall	Reimb	186.42
JOtt	Refund	258.73
JStowers	Reimb	250.00
JacobsEngnrng	Services	128,833.93
JKCEngnrng	Services	4,847.75
JhnsnRstrnt	Services	1,206.00
KHallock	Reimb	30.00
KHawthorne	Refund	380.00
KNealeigh	Refund	275.16
KashCorp	Goods	2,581.98
Kinsco	Goods	9,729.33
KiwanisClb	Dues	228.00
KnfRvr	Services	8,335.35
KotoCspr	Refund	1,203.53
LDrake	Reimb	120.00
LngdnInvstmnts	Refund	234.02
Lisa'sSpcNSpn	Services	770.00
LongBldgTech	Services	1,540.00
MBrattis	Reimb	30.00
MBrummond	Reimb	120.00
MKolker	Reimb	72.40
MWalz	Refund	21.30
MeyersCnstrctn	Services	10,780.00
MrcI RcrtnEqpmnt	Goods	1,173.21
MonsnJntrlSrvc	Services	6,201.94
Motn&FlowCntrl	Goods	99.32
MotorlaSltns	Services	71,305.50
MtnStLitho	Services	66.93
MtnStsPipe	Goods	10,690.78
MtnWstTech	Services	1,129.32
MunicplTrtmnt	Goods	6,545.00
NCarlson	Reimb	120.00
Napa	Goods	126,097.95
NCWeed&Pest	Goods	810.64
Nlson/NygrdConsult	Services	9,778.51
NJCrmnlIntrdc	Services	498.00
Norco	Goods	519.88

NrthAmrcnRescue	Goods	6,986.94
NrthrnLights	Services	720.00
OneCall	Services	1,380.00
PKuxhausen	Reimb	120.00
PaceAnlytclSrvcs	Services	2,883.33
Pedens	Goods	211.00
PstlPros	Services	6,469.94
Prntwrks	Services	143.82
RMay	Refund	252.09
RmshrnCnstretn	Services	269,766.27
RDOffut	Goods/Services	68,729.00
Ricoh	Services	547.07
RckyMtnPwr	Utilities	103,620.39
RogueMchncl	Services	275.00
RootrSwr	Services	1,185.30
RuffKuttKstmz	Services	6,500.00
SeaWstrn	Goods	21,773.87
SkyIneRnchs	Services	6.54
Smrsh	Services	1,957.50
SmthPsych	Services	600.00
SpareLabs	Services	750.00
StOfWyo	Services	171,639.39
StrlngInfosystms	Services	1,304.89
StrtgcGvrnmnt	Services	13,900.00
SWI	Services	63,921.92
TenEPckgng	Goods	2,565.00
TDach	Services	600.00
TMcCoul	Refund	190.10
TheWash	Services	13.82
33MileRd	Services	82.96
ThomsnReutrs	Goods	993.42
TopOffc	Goods	634.46
TrnsUnionRsk	Services	185.40
TriStOilReclm	Services	447.00
Unifrms2Gear	Goods	4,812.79
VrznWrsls	Services	536.45
WBeer	Reimb	150.00

WGonzales	Reimb	75.00
W/Sholding#1	Refund	1,068.51
WardwlWtr	Goods	157.03
WyneColemnConst	Services	3,781.85
WCCRstrtn	Services	7,839.44
WearPrts	Goods	88.95
WthrbyPrnt	Services	5,207.00
WstPlainsEngrng	Services	2,000.00
WstrnRsrch	Goods	4,505.62
WstIndPrk	Services	1,682.06
WLCEngrng	Services	7,627.95
WyoMchnry	Services	8,098.43
WyoLowVltge	Goods	225.00
WyoPlantCmpny	Goods	1,106.94
WyoStGolf	Services	360.00
WyoSteel&Rcyclng	Goods	474.10
XylmWtrSoltns	Services	8,509.00
Total		4,024,962.70

5. COMMUNICATIONS FROM PERSONS PRESENT

Individuals addressing Council were: Dean Welch, 1604 S Wilson, regarding the Fallen Veteran's Memorial arch.

9.A. ESTABLISH PUBLIC HEARINGS

Moved by Councilmember Cathey, seconded by Councilmember Sutherland, to, by minute action: establish October 4, 2022, as the public hearing date for the consideration of new Restaurant Liquor License No. 48 for Blues Gypsy, LLC, dba the Bluebird at the Cheese Barrel, located at 544 South Center. Councilmembers Pollock and McIntosh abstained from voting. Motion passed.

7.A.1. PUBLIC HEARING – ORDINANCE

Mayor Pacheco opened the public hearing for the consideration of an ordinance pertaining to North Platte River Park. No. 2 Subdivision.

City Attorney Henley entered two (2) exhibits: correspondence from Liz Becher to J. Carter Napier, dated September 12, 2022; and an affidavit of publication, as published in the Casper Star-Tribune, dated September 15, 2022.

Acting City Manager, Liz Becher, gave a brief report and answered questions from City Council.

There was no one to speak in favor of the item. Speaking in opposition was: Keith Tyler, 6013 River Park Dr. Councilmembers answered questions Mr. Tyler rose regarding the zoning changes. There being no other citizens to speak for or against the issue, the public hearing was closed.

Following ordinance read:

ORDINANCE NO. 15-22
AN ORDINANCE APPROVING A PARTIAL PLAT,
VACATION, REPLAT, VACATION OF PUBLIC PARKLAND
AND A ZONE CHANGE FOR THE NORTH PLATTE RIVER
PARK NO. 2 SUBDIVISION.

Councilmember Cathey presented the foregoing ordinance for approval, on first reading. Seconded by Councilmember Sutherland. Councilmember McIntosh abstained from voting. Motion passed.

7.A.2. PUBLIC HEARING – ORDINANCE

Mayor Pacheco opened the public hearing for the consideration of an ordinance pertaining to the annexation of Dowler No. 2 Subdivision and rezoning of Paradise Acres Addition.

City Attorney Henley entered two (2) exhibits: correspondence from Liz Becher to J. Carter Napier, dated September 12, 2022; and an affidavit of publication, as published in the Casper Star-Tribune, dated August 29, 2022.

Acting City Manager, Liz Becher, gave a brief report and answered questions from City Council.

Speaking in favor of the item was: Dan Elston, 85 Primrose St. There was no one to speak in opposition. There being no other citizens to speak for or against the issue, the public hearing was closed.

Following ordinance read:

ORDINANCE NO. 16-22
AN ORDINANCE APPROVING THE ANNEXATION OF 2.0
ACRES DESCRIBED AS TRACT 8, DOWLER NO. 2
SUBDIVISION (3025 PARADISE DRIVE), ESTABLISHING
THE ZONING OF SAID PARCEL AS C-2 (GENERAL
BUSINESS), AND REZONING 8.2-ACRES DESCRIBED AS
THE PARADISE ACRES ADDITION (3041 PARADISE DRIVE)
AS C-2 (GENERAL BUSINESS).

Councilmember Pollock presented the foregoing ordinance for approval, on first reading. Seconded by Councilmember Engebretsen. Councilmember McIntosh abstained from voting. Motion passed.

8. ORDINANCE– SECOND READING

Following ordinance read:

ORDINANCE NO. 14-22
AN ORDINANCE CORRECTING A SCRIVENER’S ERROR IN
THE LEGAL DESCRIPTION OF ORDINANCE NO. 34-19
PERTAINING TO THE MISTAKEN INCLUSION, VIA
ANNEXATION, OF THE WEST HALF OF LOTS 26 & 27,
SOUTH GARDEN CREEK ACRES NO. 2 ADDITION IN THE

CASPER MUNICIPAL LIMITS.

Councilmember Cathey presented the foregoing ordinance for approval, on second reading. Seconded by Councilmember Pollock. Motion passed.

9. CONSENT RESOLUTIONS

The following resolutions were considered, by consent agenda:

RESOLUTION NO. 22-163

A RESOLUTION AUTHORIZING AN IRU AGREEMENT BETWEEN THE CITY OF CASPER AND WERCS COMMUNICATION, INC., D.B.A. MOUNTAIN WEST TECHNOLOGIES CORPORATION FOR FIBER OPTIC CABLING SERVICES.

RESOLUTION NO. 22-164

A RESOLUTION AUTHORIZING A CONTRACT FOR PROFESSIONAL SERVICES WITH DESERT MOUNTAIN CORPORATION, FOR THE STREET ICE SLICER PROCURMENT, PROJECT NO. 22-049.

RESOLUTION NO. 22-165

A RESOLUTION AUTHORIZING AMENDMENT NO. 2 TO THE CONTRACT FOR PROFESSIONAL SERVICES WITH STATE LINE NO. 7 ARCHITECTS, FOR DESIGN SERVICES FOR THE CITY HALL RENOVATION AND ADDITION (PROJECT SAFE), PROJECT NO. 20-004.

RESOLUTION NO. 22-166

A RESOLUTION AUTHORIZING A COOPERATIVE AGREEMENT WITH THE WYOMING DEPARTMENT OF TRANSPORTATION FOR STREET ENHANCEMENTS RELATED TO THE POPLAR STREET IMPROVEMENTS – CY AVENUE TO COLLINS DRIVE.

RESOLUTION NO. 22-167

A RESOLUTION AUTHORIZING THE EXECUTION OF AN ACCESS PERMIT WITH THE WYOMING DEPARTMENT OF TRANSPORTATION FOR ACCESS WIDENING AN ACCESS APPROACH AT 935 WEST YELLOWSTONE HIGHWAY.

RESOLUTION NO. 22-168

A RESOLUTION ISSUING A REVOCABLE LICENSE AGREEMENT WITH 6H GROUP, LLC, DBA NOLAND FEED, FOR MAINTENANCE OF A LOADING DOCK WITHIN CITY RIGHT-OF-WAY.

RESOLUTION NO. 22-169

A RESOLUTION AUTHORIZING AN AGREEMENT WITH JTL GROUP, INC., DBA KNIFE RIVER, FOR THE 2022 PLATTE RIVER TRAILS REPLACEMENTS PROJECT NO. 22-042.

RESOLUTION NO. 22-170

A RESOLUTION AUTHORIZING A DONATION AGREEMENT

BETWEEN THE AMERICAN LEGIONA GEORGE W. VROMAN POST 2 AND THE CITY OF CASPER LOCATED AT PATERSON-ZONTA PARK FOR WYOMING'S FALLEN MEMORIAL, PROJECT NO. 20-055.

RESOLUTION NO. 22-171

A RESOLUTION AMENDING THE CITY OF CASPER STATEMENT OF INVESTMENT POLICY.

RESOLUTION NO. 22-172

A RESOLUTION AUTHORIZING A PROMISSORY NOTE TO THE STATE OF WYOMING IN THE AMOUNT OF \$7,294,117.60 TO FUND FIRE PENSION A.

RESOLUTION NO. 22-173

A RESOLUTION AUTHORIZING THE COMMUNITY DEVELOPMENT BLOCK GRANT – COVID FUNDS (CDBG-CV) AGREEMENT IN THE AMOUNT OF SEVEN HUNDRED FIFTY THOUSAND DOLLARS (\$750,000) BETWEEN THE CITY OF CASPER AND THE WYOMING COMMUNITY DEVELOPMENT AUTHORITY (WCDA) TO ASSIST IN THE FUNDING FOR THE WYOMING FOOD FOR THOUGH GROCERY STORE AT THE SITE OF THE FORMER NORTH CASPER SCHOOL.

RESOLUTION NO. 22-174

A RESOLUTION AUTHORIZING THE COMMUNITY DEVELOPMENT BLOCK GRANT (CDBG) AGREEMENT IN THE AMOUNT OF FIVE HUNDRED THOUSAND DOLLARS (\$500,000) BETWEEN THE CITY OF CASPER AND THE WYOMING COMMUNITY DEVELOPMENT AUTHORITY (WCDA) TO ASSIST IN THE FUNDING OF THE RENOVATIONS FOR THE WILLARD ENVISION CENTER WITH THE CASPER HOUSING AUTHORITY.

Councilmember Sutherland presented the foregoing twelve (12) resolutions for adoption. Seconded by Councilmember Pollock. Acting City Manager Becher briefly discussed the two resolutions related to CDBG agreements. Councilmember Gamroth abstained from voting on Resolution No. 22-163 and Vice Mayor Knell abstained from voting on Resolution No. 22-165. Motion passed.

10.A. MINUTE ACTION– CONSENT

Moved by Councilmember Engebretsen, seconded by Councilmember Pollock to, by consent minute action:

1. Authorize the re-appointment of Bill Thompson to the City of Casper Investment Advisory Committee;
2. Authorize the purchase of one (1) John Deer 310SL Backhoe Loader and Grapple Bucket in the total amount of \$149,875.17, before trade-in, for use by the Parks Division of the Parks, Recreation, and Public Facilities Department;
3. Authorize the purchase of one (1) new wide area mower, in the total amount of \$80,900.00, before trade, for use by the Parks Division of the Parks, Recreation, and Public Facilities Department;

4. Appoint Travis Van Hecke to the Casper Planning and Zoning Commission;
5. Approve the sole source purchase of three commercial truck packs for use in the Community Risk Reduction Officer fire vehicles from Iconic Metal Gear in the amount of \$43,349.07; and
6. Approve the sole source purchase of equipment and installation of equipment by Communication Technologies, Inc., in the amount of \$44,984.

Councilmember McIntosh abstained from voting on Item 10.A.4. Motion passed.

11. INTRODUCTION OF MEASURES AND PROPOSALS

Councilmembers spoke on meetings and events they attended as well as matters of public interest.

12. ADJOURN INTO EXECUTIVE SESSION

At 6:48 p.m., it was moved Councilmember Cathey, seconded by Vice Mayor Knell, to adjourn into executive session to discuss personnel, litigation, land acquisition. Motion passed. Council moved into the Council Meeting Room.

At 8:58 p.m., it was moved by Councilmember Cathey, seconded by Councilmember Engebretsen, to adjourn the executive session. Motion passed.

13. ADJOURNMENT

The meeting was opened to the public. At 8:59 p.m., it was moved by Councilmember Cathey, seconded by Councilmember Engebretsen, to adjourn the regular Council meeting. Motion passed.

ATTEST:

CITY OF CASPER, WYOMING
A Municipal Corporation

Fleur Tremel
City Clerk

Ray Pacheco
Mayor

City of Casper - Bills and Claims for October 04, 2022

4IMPRINT, INC

4IMPRINT, INC	Human Resources	100 Custom Certificate Holders	\$125.08
<i>4IMPRINT, INC - Total For Human Resources</i>			<i>\$125.08</i>
4IMPRINT, INC	Metro Animal Shelter	ALL OTHER DIRECT MARKETERS	\$588.78
<i>4IMPRINT, INC - Total For Metro Animal Shelter</i>			<i>\$588.78</i>
4IMPRINT, INC	Police Administration	100 Custom Certificate Holders	\$104.18
<i>4IMPRINT, INC - Total For Police Administration</i>			<i>\$104.18</i>
4IMPRINT, INC - ALL DEPARTMENTS			\$818.04

6H GROUP LLC

6H GROUP LLC	Metro Animal Shelter	Dog food, puppy food & cat food	\$704.65
<i>6H GROUP LLC - Total For Metro Animal Shelter</i>			<i>\$704.65</i>
6H GROUP LLC - ALL DEPARTMENTS			\$704.65

71 CONSTRUCTION, INC

71 CONSTRUCTION, INC	Water Distribution	Derington Addition Watermain R	\$72,257.40
<i>71 CONSTRUCTION, INC - Total For Water Distribution</i>			<i>\$72,257.40</i>
71 CONSTRUCTION, INC	Water Revenue and Transfers Contract Retainage - Contract #22300176		\$3,803.02
<i>71 CONSTRUCTION, INC - Total For Water Revenue and Transfers</i>			<i>\$3,803.02</i>
71 CONSTRUCTION, INC - ALL DEPARTMENTS			\$76,060.42

A.M.B.I. & SHIPPING,

A.M.B.I. & SHIPPING,	Balefill - Disposal & Landfill	Postage / mailing service	\$27.14
<i>A.M.B.I. & SHIPPING, - Total For Balefill - Disposal & Landfill</i>			<i>\$27.14</i>
A.M.B.I. & SHIPPING,	Ft. Caspar Museum	Postage / mailing service	\$2.01
<i>A.M.B.I. & SHIPPING, - Total For Ft. Caspar Museum</i>			<i>\$2.01</i>
A.M.B.I. & SHIPPING,	Refuse - Residential	Postage / mailing service	\$4.02
<i>A.M.B.I. & SHIPPING, - Total For Refuse - Residential</i>			<i>\$4.02</i>
A.M.B.I. & SHIPPING, - ALL DEPARTMENTS			\$33.17

AAA LANDSCAPING

AAA LANDSCAPING	Balefill - Disposal & Landfill	Mowing & trimming service	\$1,115.00
<i>AAA LANDSCAPING - Total For Balefill - Disposal & Landfill</i>			<i>\$1,115.00</i>
AAA LANDSCAPING	Community Development	Mowing / trimming service	\$2,563.48
<i>AAA LANDSCAPING - Total For Community Development</i>			<i>\$2,563.48</i>
AAA LANDSCAPING - ALL DEPARTMENTS			\$3,678.48

AC TREE SERVICE

AC TREE SERVICE	Parks - Urban Forestry	Tree removal & stump grinding	\$1,500.00
<i>AC TREE SERVICE - Total For Parks - Urban Forestry</i>			<i>\$1,500.00</i>
AC TREE SERVICE - ALL DEPARTMENTS			\$1,500.00

AHERN RENTALS INC

AHERN RENTALS INC	Balefill - Diversion & Special	Pressure Washer	\$10,060.00
<i>AHERN RENTALS INC - Total For Balefill - Diversion & Special</i>			<i>\$10,060.00</i>
AHERN RENTALS INC	Water Distribution	SS Nozzles Other Materials & SUPplies	\$18.30
<i>AHERN RENTALS INC - Total For Water Distribution</i>			<i>\$18.30</i>
AHERN RENTALS INC - ALL DEPARTMENTS			\$10,078.30

AIR INNOVATIONS

AIR INNOVATIONS	Balefill - Baler Processing	Maintenance on furnace	\$570.00
<i>AIR INNOVATIONS - Total For Balefill - Baler Processing</i>			<i>\$570.00</i>
AIR INNOVATIONS - ALL DEPARTMENTS			\$570.00

AIRGAS USA LLC

AIRGAS USA LLC	Balefill - Baler Processing	Welding supplies	\$357.86
<i>AIRGAS USA LLC - Total For Balefill - Baler Processing</i>			<i>\$357.86</i>
AIRGAS USA LLC	Refuse - Residential	Oil spill kit	\$343.76
<i>AIRGAS USA LLC - Total For Refuse - Residential</i>			<i>\$343.76</i>
AIRGAS USA LLC - ALL DEPARTMENTS			\$701.62

ALL-OUT-FIRE EXT

ALL-OUT-FIRE EXT	Refuse - Residential	Fire extinguisher recharge	\$74.00
ALL-OUT-FIRE EXT	Refuse - Residential	Fire extinguisher recharge	\$85.00

ALL-OUT-FIRE EXT - Total For Refuse - Residential \$159.00

ALL-OUT-FIRE EXT - ALL DEPARTMENTS \$159.00

ALSCO

ALSCO	Balefill - Disposal & Landfill	Professional Laundry Services	\$58.82
ALSCO	Balefill - Disposal & Landfill	Professional Laundry Services	\$58.82
ALSCO	Balefill - Disposal & Landfill	Professional Laundry Services	\$80.50
ALSCO	Balefill - Disposal & Landfill	Professional Laundry Services	\$80.50
ALSCO	Balefill - Disposal & Landfill	Professional Laundry Services	\$83.00

ALSCO - Total For Balefill - Disposal & Landfill \$361.64

ALSCO	Fleet Maintenance Fund	Laundry service	\$128.79
ALSCO	Fleet Maintenance Fund	Laundry service	\$171.54
ALSCO	Fleet Maintenance Fund	Laundry service	\$128.79
ALSCO	Fleet Maintenance Fund	Laundry service	\$171.54

ALSCO - Total For Fleet Maintenance Fund \$600.66

ALSCO	Refuse - Residential	Professional Laundry Services	\$110.56
ALSCO	Refuse - Residential	Professional Laundry Services	\$110.56
ALSCO	Refuse - Residential	Professional Laundry Services	\$110.06

ALSCO - Total For Refuse - Residential \$331.18

ALSCO	WWTP Operations	Professional Laundry Services	\$138.30
ALSCO	WWTP Operations	Professional Laundry Services	\$136.30

ALSCO - Total For WWTP Operations \$274.60

ALSCO - ALL DEPARTMENTS \$1,568.08

AMAZON.COM 1M15W9Y01

AMAZON.COM 1M15W9Y0	Buildings & Structures Fund	Custodial Supplies for Rec Center - Amazon	\$113.85
---------------------	-----------------------------	--	----------

AMAZON.COM 1M15W9Y01 - Total For Buildings & Structures Fund \$113.85

AMAZON.COM 1M15W9Y01 - ALL DEPARTMENTS \$113.85

AMAZON.COM 1V9V85SZ1

AMAZON.COM 1V9V85SZ1	Aquatics - Operations	Sanitary Bin Liners	\$30.51
<i>AMAZON.COM 1V9V85SZ1 - Total For Aquatics - Operations</i>			<i>\$30.51</i>
AMAZON.COM 1V9V85SZ1 - ALL DEPARTMENTS			\$30.51

AMERICAN WATER COLLE

AMERICAN WATER COLLE	WWTP Operations	STHOMAS TRAINING COURSE	\$199.95
<i>AMERICAN WATER COLLE - Total For WWTP Operations</i>			<i>\$199.95</i>
AMERICAN WATER COLLE - ALL DEPARTMENTS			\$199.95

AMERIGAS - CASPER

AMERIGAS - CASPER	Balefill - Baler Processing	Propane	\$432.32
AMERIGAS - CASPER	Balefill - Baler Processing	Propane	\$175.35
<i>AMERIGAS - CASPER - Total For Balefill - Baler Processing</i>			<i>\$607.67</i>
AMERIGAS - CASPER - ALL DEPARTMENTS			\$607.67

AMERI-TECH EQUIPMENT

AMERI-TECH EQUIPMENT	Fleet Maintenance Fund	Vehicle repair	\$1,419.76
<i>AMERI-TECH EQUIPMENT - Total For Fleet Maintenance Fund</i>			<i>\$1,419.76</i>
AMERI-TECH EQUIPMENT	Refuse - Residential	Toolbox	\$496.00
<i>AMERI-TECH EQUIPMENT - Total For Refuse - Residential</i>			<i>\$496.00</i>
AMERI-TECH EQUIPMENT - ALL DEPARTMENTS			\$1,915.76

AMZN Mktp US

AMZN Mktp US	Buildings & Structures Fund	Repair supplies for Aquatics Center - Amazon	\$251.29
AMZN Mktp US	Buildings & Structures Fund	Custodial Supplies for Rec Center - Amazon	\$83.00
<i>AMZN Mktp US - Total For Buildings & Structures Fund</i>			<i>\$334.29</i>
AMZN Mktp US	Golf - Operations	Barcode Labels office supplies	\$49.90
<i>AMZN Mktp US - Total For Golf - Operations</i>			<i>\$49.90</i>
AMZN Mktp US	Ice Arena - Operations	Money Deposit Bags	\$97.95
<i>AMZN Mktp US - Total For Ice Arena - Operations</i>			<i>\$97.95</i>
AMZN Mktp US	Water Distribution	Logitech MK570 Keyboard/Mouse Amazon T	\$89.24
<i>AMZN Mktp US - Total For Water Distribution</i>			<i>\$89.24</i>

AMZN Mktp US - ALL DEPARTMENTS \$571.38

ANDRITZ SEPERATION I

ANDRITZ SEPERATION I WWTP Operations Cover gasket \$734.69

ANDRITZ SEPERATION I - Total For WWTP Operations \$734.69

ANDRITZ SEPERATION I - ALL DEPARTMENTS \$734.69

ANIMAL CARE EQUIPMEN

ANIMAL CARE EQUIPMEN Metro Animal Shelter PET SHOPS-PET FOOD AND SUPPLY STORES \$98.85

ANIMAL CARE EQUIPMEN - Total For Metro Animal Shelter \$98.85

ANIMAL CARE EQUIPMEN - ALL DEPARTMENTS \$98.85

AT & T CORP

AT & T CORP Public Transit - CARES Act Acct #287306431868 \$291.16

AT & T CORP - Total For Public Transit - CARES Act \$291.16

AT & T CORP Regional Water Operations Acct #287311040412 \$40.04

AT & T CORP - Total For Regional Water Operations \$40.04

AT & T CORP Streets Acct #287294643026 \$200.20

AT & T CORP - Total For Streets \$200.20

AT & T CORP - ALL DEPARTMENTS \$531.40

ATLANTIC ELECTRIC, I

ATLANTIC ELECTRIC, I Capital Projects Fund 12th & Wolcott signal repairs \$10,522.00

ATLANTIC ELECTRIC, I - Total For Capital Projects Fund \$10,522.00

ATLANTIC ELECTRIC, I General Fund Revenue Contract Withholding: 22300190 \$1,737.60

ATLANTIC ELECTRIC, I - Total For General Fund Revenue \$1,737.60

ATLANTIC ELECTRIC, I Risk Management 322 W Midwest luminaire repair \$13,800.00

ATLANTIC ELECTRIC, I - Total For Risk Management \$13,800.00

ATLANTIC ELECTRIC, I - ALL DEPARTMENTS \$26,059.60

ATLAS OFFICE PRODUCT

ATLAS OFFICE PRODUCT Balefill - Disposal & Landfill Office supplies \$43.78

ATLAS OFFICE PRODUCT	Balefill - Disposal & Landfill	Office supplies	\$109.67
ATLAS OFFICE PRODUCT	Balefill - Disposal & Landfill	Office supplies	\$22.04
<i>ATLAS OFFICE PRODUCT - Total For Balefill - Disposal & Landfill</i>			<i>\$175.49</i>
ATLAS OFFICE PRODUCT	City Attorney	Office supplies	\$119.97
ATLAS OFFICE PRODUCT	City Attorney	Office supplies	\$231.94
<i>ATLAS OFFICE PRODUCT - Total For City Attorney</i>			<i>\$351.91</i>
ATLAS OFFICE PRODUCT	City Clerk	COMMERCIAL EQUIPMENT, NOT ELSEWHERE	\$70.93
<i>ATLAS OFFICE PRODUCT - Total For City Clerk</i>			<i>\$70.93</i>
ATLAS OFFICE PRODUCT	Community Development	Office supplies	\$111.20
ATLAS OFFICE PRODUCT	Community Development	Office supplies	\$59.97
ATLAS OFFICE PRODUCT	Community Development	Office supplies	\$14.99
<i>ATLAS OFFICE PRODUCT - Total For Community Development</i>			<i>\$186.16</i>
ATLAS OFFICE PRODUCT	Engineering	COMMERCIAL EQUIPMENT, NOT ELSEWHERE	\$18.50
ATLAS OFFICE PRODUCT	Engineering	SAFETY GLASSES	\$30.95
ATLAS OFFICE PRODUCT	Engineering	COMMERCIAL EQUIPMENT, NOT ELSEWHERE	\$25.09
<i>ATLAS OFFICE PRODUCT - Total For Engineering</i>			<i>\$74.54</i>
ATLAS OFFICE PRODUCT	Fleet Maintenance Fund	Office supplies	\$326.19
ATLAS OFFICE PRODUCT	Fleet Maintenance Fund	Office supplies	\$83.04
ATLAS OFFICE PRODUCT	Fleet Maintenance Fund	Office supplies	\$59.33
<i>ATLAS OFFICE PRODUCT - Total For Fleet Maintenance Fund</i>			<i>\$468.56</i>
ATLAS OFFICE PRODUCT	Ft. Caspar Museum	2023 Calendar for staff schedules	\$59.11
<i>ATLAS OFFICE PRODUCT - Total For Ft. Caspar Museum</i>			<i>\$59.11</i>
ATLAS OFFICE PRODUCT	Human Resources	1 Custom Ink Stamp	\$45.79
ATLAS OFFICE PRODUCT	Human Resources	1 box grey orientation folders, 1 box blue be	\$29.66
<i>ATLAS OFFICE PRODUCT - Total For Human Resources</i>			<i>\$75.45</i>
ATLAS OFFICE PRODUCT	Metro Animal Shelter	Office supplies	\$479.84
ATLAS OFFICE PRODUCT	Metro Animal Shelter	Office supplies	\$95.33
ATLAS OFFICE PRODUCT	Metro Animal Shelter	Office supplies	\$89.31
ATLAS OFFICE PRODUCT	Metro Animal Shelter	Office supplies	\$193.28
ATLAS OFFICE PRODUCT	Metro Animal Shelter	Office supplies	\$489.90
<i>ATLAS OFFICE PRODUCT - Total For Metro Animal Shelter</i>			<i>\$1,347.66</i>
ATLAS OFFICE PRODUCT	Police Administration	Office supplies	\$541.30
ATLAS OFFICE PRODUCT	Police Administration	Office supplies	\$0.92
ATLAS OFFICE PRODUCT	Police Administration	Office supplies	\$259.81
ATLAS OFFICE PRODUCT	Police Administration	Office supplies	\$215.94
ATLAS OFFICE PRODUCT	Police Administration	Office supplies	\$990.08

ATLAS OFFICE PRODUCT	Police Administration	Office supplies	\$28.77
<i>ATLAS OFFICE PRODUCT - Total For Police Administration</i>			<i>\$2,036.82</i>
ATLAS OFFICE PRODUCT	Public Safety Communication	Office supplies	\$266.17
<i>ATLAS OFFICE PRODUCT - Total For Public Safety Communications</i>			<i>\$266.17</i>
ATLAS OFFICE PRODUCT	Refuse - Residential	Office supplies	\$24.45
ATLAS OFFICE PRODUCT	Refuse - Residential	Office supplies	\$22.04
<i>ATLAS OFFICE PRODUCT - Total For Refuse - Residential</i>			<i>\$46.49</i>
ATLAS OFFICE PRODUCT	Regional Water Operations	Large & Medium Binder Clips - Office Supplie	\$4.08
ATLAS OFFICE PRODUCT	Regional Water Operations	Laundry Detergent, Dryer Sheets, Copy Stam	\$87.79
<i>ATLAS OFFICE PRODUCT - Total For Regional Water Operations</i>			<i>\$91.87</i>
ATLAS OFFICE PRODUCT	Risk Management	Office supplies	\$489.19
ATLAS OFFICE PRODUCT	Risk Management	Office supplies	\$21.16
ATLAS OFFICE PRODUCT	Risk Management	1 box grey orientation folders, 1 box blue be	\$29.22
<i>ATLAS OFFICE PRODUCT - Total For Risk Management</i>			<i>\$539.57</i>
ATLAS OFFICE PRODUCT - ALL DEPARTMENTS			\$5,790.73

ATLAS REPRODUCTION

ATLAS REPRODUCTION	Community Development	Printing / laminating service	\$30.00
ATLAS REPRODUCTION	Community Development	Printing / laminating service	\$42.00
<i>ATLAS REPRODUCTION - Total For Community Development</i>			<i>\$72.00</i>
ATLAS REPRODUCTION - ALL DEPARTMENTS			\$72.00

AVIS.COM PREPAY

AVIS.COM PREPAY	Water Meters	Car Rental for Neptune Meter School - Travel	\$263.54
<i>AVIS.COM PREPAY - Total For Water Meters</i>			<i>\$263.54</i>
AVIS.COM PREPAY - ALL DEPARTMENTS			\$263.54

B&B RUBBER STAMP

B&B RUBBER STAMP	City Attorney	Office supplies	\$89.80
B&B RUBBER STAMP	City Attorney	Office supplies	\$24.95
<i>B&B RUBBER STAMP - Total For City Attorney</i>			<i>\$114.75</i>
B&B RUBBER STAMP	Fleet Maintenance Fund	Office supplies	\$65.70
<i>B&B RUBBER STAMP - Total For Fleet Maintenance Fund</i>			<i>\$65.70</i>

B&B RUBBER STAMP - ALL DEPARTMENTS

\$180.45

BAILEY'S ACE HARDWAR

BAILEY'S ACE HARDWAR	Balefill - Baler Processing	Spray paint	\$30.55
<i>BAILEY'S ACE HARDWAR - Total For Balefill - Baler Processing</i>			\$30.55
BAILEY'S ACE HARDWAR	Balefill - Disposal & Landfill	Tree root stimulator & fertilizer	\$28.97
<i>BAILEY'S ACE HARDWAR - Total For Balefill - Disposal & Landfill</i>			\$28.97
BAILEY'S ACE HARDWAR	Balefill - Diversion & Special	Fasteners	\$12.40
<i>BAILEY'S ACE HARDWAR - Total For Balefill - Diversion & Special</i>			\$12.40
BAILEY'S ACE HARDWAR	Refuse - Recycling	Clamp	\$27.96
<i>BAILEY'S ACE HARDWAR - Total For Refuse - Recycling</i>			\$27.96
BAILEY'S ACE HARDWAR - ALL DEPARTMENTS			\$99.88

BAILEYS ACE HDWE

BAILEYS ACE HDWE	Buildings & Structures Fund	Supplies to repair Ice Arena water leak - Bail	\$15.78
BAILEYS ACE HDWE	Buildings & Structures Fund	Repair supplies for Marion Kreiner Pool - Bail	\$6.99
BAILEYS ACE HDWE	Buildings & Structures Fund	Repair supplies for Ice Arena - Baileys Ace	\$28.69
<i>BAILEYS ACE HDWE - Total For Buildings & Structures Fund</i>			\$51.46
BAILEYS ACE HDWE	Parks - Athletic Maint.	Keys for Crossroads Storage Building (new lo	\$14.34
<i>BAILEYS ACE HDWE - Total For Parks - Athletic Maint.</i>			\$14.34
BAILEYS ACE HDWE	Rec Center - Classes	Tape for TKD Tournament & Program	\$37.74
<i>BAILEYS ACE HDWE - Total For Rec Center - Classes</i>			\$37.74
BAILEYS ACE HDWE	Weed & Pest Fund	Parts	\$24.16
<i>BAILEYS ACE HDWE - Total For Weed & Pest Fund</i>			\$24.16
BAILEYS ACE HDWE - ALL DEPARTMENTS			\$127.70

BARGREEN ELLINGSON

BARGREEN ELLINGSON	Buildings & Structures Fund	Freezer door	\$2,611.00
<i>BARGREEN ELLINGSON - Total For Buildings & Structures Fund</i>			\$2,611.00
BARGREEN ELLINGSON	Capital Projects Fund	Freezer door	\$1,037.14
<i>BARGREEN ELLINGSON - Total For Capital Projects Fund</i>			\$1,037.14
BARGREEN ELLINGSON	Fire-EMS Operations	Station 3 Ice Maker	\$3,289.42
<i>BARGREEN ELLINGSON - Total For Fire-EMS Operations</i>			\$3,289.42

BARGREEN ELLINGSON	Golf - Operations	Freezer door	\$1,573.86
<i>BARGREEN ELLINGSON - Total For Golf - Operations</i>			<i>\$1,573.86</i>
BARGREEN ELLINGSON	Public Transit - CARES Act	Paper towels & bathroom tissue	\$400.28
<i>BARGREEN ELLINGSON - Total For Public Transit - CARES Act</i>			<i>\$400.28</i>
BARGREEN ELLINGSON - ALL DEPARTMENTS			\$8,911.70

BARGREEN WYOMING

BARGREEN WYOMING	Ice Arena - Operations	NSF/ANSI Coffee Machine - Concession Equi	\$460.57
BARGREEN WYOMING	Ice Arena - Operations	Cappuccino / Hot Chocolate Machine Replac	\$1,658.75
<i>BARGREEN WYOMING - Total For Ice Arena - Operations</i>			<i>\$2,119.32</i>
BARGREEN WYOMING	Regional Water Operations	Bigger Ice Scoop for Ice Machine - Office Sup	\$6.79
<i>BARGREEN WYOMING - Total For Regional Water Operations</i>			<i>\$6.79</i>
BARGREEN WYOMING - ALL DEPARTMENTS			\$2,126.11

BEST WESTERN DUNMAR

BEST WESTERN DUNMAR	Aquatics - Operations	Hotel for WRPA Conference	\$247.47
<i>BEST WESTERN DUNMAR - Total For Aquatics - Operations</i>			<i>\$247.47</i>
BEST WESTERN DUNMAR	Rec Center - Admin	WRPA 2022 Evanston Wy Conference	\$247.47
<i>BEST WESTERN DUNMAR - Total For Rec Center - Admin</i>			<i>\$247.47</i>
BEST WESTERN DUNMAR - ALL DEPARTMENTS			\$494.94

BLACK HILLS ENERGY

BLACK HILLS ENERGY	Ash Street Building	Acct #4376 8927 11	\$318.96
BLACK HILLS ENERGY	Ash Street Building	Acct #0421 9638 76	\$32.81
<i>BLACK HILLS ENERGY - Total For Ash Street Building</i>			<i>\$351.77</i>
BLACK HILLS ENERGY	Balefill - Disposal & Landfill	Acct #7538 8605 37	\$29.00
BLACK HILLS ENERGY	Balefill - Disposal & Landfill	Acct #1919 8530 97	\$513.70
<i>BLACK HILLS ENERGY - Total For Balefill - Disposal & Landfill</i>			<i>\$542.70</i>
BLACK HILLS ENERGY	Buildings & Structures Fund	Acct #8545 6521 02	\$55.19
<i>BLACK HILLS ENERGY - Total For Buildings & Structures Fund</i>			<i>\$55.19</i>
BLACK HILLS ENERGY	Casper Business Center	Acct #4620 7426 21	\$630.68
<i>BLACK HILLS ENERGY - Total For Casper Business Center</i>			<i>\$630.68</i>
BLACK HILLS ENERGY	Cemetery	Acct #9629 0042 60	\$29.60

<i>BLACK HILLS ENERGY - Total For Cemetery</i>			\$29.60
BLACK HILLS ENERGY	City Center Building	Acct #8545 6521 02	\$20.00
<i>BLACK HILLS ENERGY - Total For City Center Building</i>			\$20.00
BLACK HILLS ENERGY	City Hall	Acct #6837 4281 65	\$1,355.70
<i>BLACK HILLS ENERGY - Total For City Hall</i>			\$1,355.70
BLACK HILLS ENERGY	Fire-EMS Administration	Acct #1783 9430 41	\$480.72
BLACK HILLS ENERGY	Fire-EMS Administration	Acct #3267 4234 58	\$77.66
BLACK HILLS ENERGY	Fire-EMS Administration	Acct #3267 4234 58	\$73.88
BLACK HILLS ENERGY	Fire-EMS Administration	Acct #1783 9430 41	\$479.56
<i>BLACK HILLS ENERGY - Total For Fire-EMS Administration</i>			\$1,111.82
BLACK HILLS ENERGY	Fleet Maintenance Fund	Acct #5293 6421 13	\$734.23
<i>BLACK HILLS ENERGY - Total For Fleet Maintenance Fund</i>			\$734.23
BLACK HILLS ENERGY	Ft. Caspar Museum	Acct #9861 5264 23	\$91.55
<i>BLACK HILLS ENERGY - Total For Ft. Caspar Museum</i>			\$91.55
BLACK HILLS ENERGY	Golf - Operations	Acct #1340 9824 25	\$363.20
BLACK HILLS ENERGY	Golf - Operations	Acct #6566 7661 30	\$55.19
<i>BLACK HILLS ENERGY - Total For Golf - Operations</i>			\$418.39
BLACK HILLS ENERGY	Ice Arena - Operations	Acct #9570 6006 61	\$753.45
<i>BLACK HILLS ENERGY - Total For Ice Arena - Operations</i>			\$753.45
BLACK HILLS ENERGY	Marathon Building	Acct #8545 6521 02	\$82.00
<i>BLACK HILLS ENERGY - Total For Marathon Building</i>			\$82.00
BLACK HILLS ENERGY	Miller St. Dormitory	Acct #8545 6521 02	\$42.27
<i>BLACK HILLS ENERGY - Total For Miller St. Dormitory</i>			\$42.27
BLACK HILLS ENERGY	Parks - Athletic Maint.	Acct #5655 3404 55	\$33.60
BLACK HILLS ENERGY	Parks - Athletic Maint.	Acct #5655 3404 55	\$30.95
<i>BLACK HILLS ENERGY - Total For Parks - Athletic Maint.</i>			\$64.55
BLACK HILLS ENERGY	Parks - Parks Maint.	Acct #2076 2356 87	\$93.25
<i>BLACK HILLS ENERGY - Total For Parks - Parks Maint.</i>			\$93.25
BLACK HILLS ENERGY	Public Transit - CARES Act	Acct #3470 5680 29	\$47.14
<i>BLACK HILLS ENERGY - Total For Public Transit - CARES Act</i>			\$47.14
BLACK HILLS ENERGY	Rec Center - Operations	Acct #4400 2150 46	\$804.43
<i>BLACK HILLS ENERGY - Total For Rec Center - Operations</i>			\$804.43
BLACK HILLS ENERGY	Water Distribution	Acct #0295 5402 18	\$285.56
<i>BLACK HILLS ENERGY - Total For Water Distribution</i>			\$285.56
BLACK HILLS ENERGY	WWTP Operations	Acct #5541 2887 44	\$1,265.17
<i>BLACK HILLS ENERGY - Total For WWTP Operations</i>			\$1,265.17

BLACK HILLS ENERGY - ALL DEPARTMENTS

\$8,779.45

BLOEDORN LUMBER CO

BLOEDORN LUMBER CO	WWTP Operations	DOOR/WINDOW CAULK	\$16.13
--------------------	-----------------	-------------------	---------

<i>BLOEDORN LUMBER CO - Total For WWTP Operations</i>			\$16.13
---	--	--	---------

BLOEDORN LUMBER CO - ALL DEPARTMENTS

\$16.13

BRENNTAG PACIFIC, IN

BRENNTAG PACIFIC, IN	Regional Water Operations	Ferric Chloride	\$16,668.80
----------------------	---------------------------	-----------------	-------------

BRENNTAG PACIFIC, IN	Regional Water Operations	Ferric Chloride	\$16,213.40
----------------------	---------------------------	-----------------	-------------

<i>BRENNTAG PACIFIC, IN - Total For Regional Water Operations</i>			\$32,882.20
---	--	--	-------------

BRENNTAG PACIFIC, IN - ALL DEPARTMENTS

\$32,882.20

C&L CYLINDER

C&L CYLINDER	Balefill - Baler Processing	SEALS AND WIPERS EJECT CYLINDER	\$808.54
--------------	-----------------------------	---------------------------------	----------

<i>C&L CYLINDER - Total For Balefill - Baler Processing</i>			\$808.54
---	--	--	----------

C&L CYLINDER - ALL DEPARTMENTS

\$808.54

CAESARS PLACE ADV RS

CAESARS PLACE ADV RS	Police Career Services	CAESARS HOTEL AND CASINO	\$191.61
----------------------	------------------------	--------------------------	----------

<i>CAESARS PLACE ADV RS - Total For Police Career Services</i>			\$191.61
--	--	--	----------

CAESARS PLACE ADV RS - ALL DEPARTMENTS

\$191.61

CAMPBELL PET COMPANY

CAMPBELL PET COMPANY	Metro Animal Shelter	PET SHOPS-PET FOOD AND SUPPLY STORES	\$307.99
----------------------	----------------------	--------------------------------------	----------

<i>CAMPBELL PET COMPANY - Total For Metro Animal Shelter</i>			\$307.99
--	--	--	----------

CAMPBELL PET COMPANY - ALL DEPARTMENTS

\$307.99

CANVA I03531-195734

CANVA I03531-195734	Metropolitan Planning Org	PHOTOGRAPHIC STUDIOS	\$119.99
---------------------	---------------------------	----------------------	----------

<i>CANVA I03531-195734 - Total For Metropolitan Planning Org</i>			\$119.99
--	--	--	----------

CANVA I03531-195734 - ALL DEPARTMENTS

\$119.99

CAPITAL BUSINESS SYS

CAPITAL BUSINESS SYS	Fleet Maintenance Fund	Copier usage	\$61.80
----------------------	------------------------	--------------	---------

<i>CAPITAL BUSINESS SYS - Total For Fleet Maintenance Fund</i>			\$61.80
--	--	--	---------

CAPITAL BUSINESS SYS - ALL DEPARTMENTS

\$61.80

CAROLINA SOFTWARE

CAROLINA SOFTWARE	Balefill - Disposal & Landfill	Software & Auto-Email Support	\$700.00
-------------------	--------------------------------	-------------------------------	----------

<i>CAROLINA SOFTWARE - Total For Balefill - Disposal & Landfill</i>			\$700.00
---	--	--	----------

CAROLINA SOFTWARE - ALL DEPARTMENTS

\$700.00

CASPER ELECTRIC, INC

CASPER ELECTRIC, INC	Balefill - Diversion & Special	Installation of electrical boxes	\$266.71
----------------------	--------------------------------	----------------------------------	----------

<i>CASPER ELECTRIC, INC - Total For Balefill - Diversion & Special</i>			\$266.71
--	--	--	----------

CASPER ELECTRIC, INC - ALL DEPARTMENTS

\$266.71

CASPER NATRONA COUNT

CASPER NATRONA COUNT	Aquatics - Operations	Routine inspection	\$85.00
----------------------	-----------------------	--------------------	---------

CASPER NATRONA COUNT	Aquatics - Operations	Routine inspection	\$85.00
----------------------	-----------------------	--------------------	---------

CASPER NATRONA COUNT	Aquatics - Operations	Routine inspection	\$85.00
----------------------	-----------------------	--------------------	---------

<i>CASPER NATRONA COUNT - Total For Aquatics - Operations</i>			\$255.00
---	--	--	----------

CASPER NATRONA COUNT	Aquatics- Mike Sedar Oper.	Routine inspection	\$60.00
----------------------	----------------------------	--------------------	---------

CASPER NATRONA COUNT	Aquatics- Mike Sedar Oper.	Routine inspection	\$85.00
----------------------	----------------------------	--------------------	---------

CASPER NATRONA COUNT	Aquatics- Mike Sedar Oper.	Routine inspection	\$85.00
----------------------	----------------------------	--------------------	---------

<i>CASPER NATRONA COUNT - Total For Aquatics- Mike Sedar Oper.</i>			\$230.00
--	--	--	----------

CASPER NATRONA COUNT	Aquatics- Paradise Valley Ope	Routine inspection	\$85.00
----------------------	-------------------------------	--------------------	---------

CASPER NATRONA COUNT	Aquatics- Paradise Valley Ope	Routine inspection	\$85.00
----------------------	-------------------------------	--------------------	---------

CASPER NATRONA COUNT	Aquatics- Paradise Valley Ope	Routine inspection	\$45.00
----------------------	-------------------------------	--------------------	---------

<i>CASPER NATRONA COUNT - Total For Aquatics- Paradise Valley Oper</i>			\$215.00
--	--	--	----------

CASPER NATRONA COUNT	Aquatics- Washington Oper	Routine inspection	\$85.00
----------------------	---------------------------	--------------------	---------

CASPER NATRONA COUNT	Aquatics- Washington Oper	Routine inspection	\$85.00
----------------------	---------------------------	--------------------	---------

<i>CASPER NATRONA COUNT - Total For Aquatics- Washington Oper</i>			\$170.00
---	--	--	----------

CASPER NATRONA COUNT - ALL DEPARTMENTS \$870.00

CASPER STAR TRIBUNE

CASPER STAR TRIBUNE City Clerk NEWS DEALERS AND NEWSSTANDS \$309.52

CASPER STAR TRIBUNE - Total For City Clerk \$309.52

CASPER STAR TRIBUNE - ALL DEPARTMENTS \$309.52

CASPER STAR-TRIBUNE,

CASPER STAR-TRIBUNE, Community Development Advertising - Casper City Council Notice \$75.84

CASPER STAR-TRIBUNE, - Total For Community Development \$75.84

CASPER STAR-TRIBUNE, Fleet Maintenance Fund Advertising - standard advertisement for pro \$140.56

CASPER STAR-TRIBUNE, - Total For Fleet Maintenance Fund \$140.56

CASPER STAR-TRIBUNE, Refuse - Residential Advertising - standard advertisement for pro \$143.44

CASPER STAR-TRIBUNE, Refuse - Residential Advertising - standard advertisement for pro \$143.44

CASPER STAR-TRIBUNE, Refuse - Residential Advertising - standard advertisement for pro \$143.44

CASPER STAR-TRIBUNE, Refuse - Residential Advertising - standard advertisement for pro \$143.44

CASPER STAR-TRIBUNE, Refuse - Residential Advertising - standard advertisement for pro \$130.92

CASPER STAR-TRIBUNE, - Total For Refuse - Residential \$704.68

CASPER STAR-TRIBUNE, - ALL DEPARTMENTS \$921.08

CASPER TIRE

CASPER TIRE Balefill - Disposal & Landfill Flat repair \$40.00

CASPER TIRE - Total For Balefill - Disposal & Landfill \$40.00

CASPER TIRE Fleet Maintenance Fund Tire tube \$25.00

CASPER TIRE Fleet Maintenance Fund Tires \$1,350.00

CASPER TIRE Fleet Maintenance Fund Flat repair / service call \$120.00

CASPER TIRE Fleet Maintenance Fund Tires \$900.00

CASPER TIRE - Total For Fleet Maintenance Fund \$2,395.00

CASPER TIRE Refuse - Recycling Flat repair \$135.00

CASPER TIRE - Total For Refuse - Recycling \$135.00

CASPER TIRE Refuse - Residential Flat repair \$45.00

CASPER TIRE Refuse - Residential Flat repair \$45.00

CASPER TIRE - Total For Refuse - Residential \$90.00

CASPER TIRE - ALL DEPARTMENTS \$2,660.00

CASPER WINAIR SUPPLY

CASPER WINAIR SUPPLY Buildings & Structures Fund HVAC repair supplies for Fire Station 3 - Wina \$238.13

CASPER WINAIR SUPPLY - Total For Buildings & Structures Fund \$238.13

CASPER WINAIR SUPPLY - ALL DEPARTMENTS \$238.13

CASPER WINNELSON

CASPER WINNELSON Buildings & Structures Fund Seat \$29.47

CASPER WINNELSON - Total For Buildings & Structures Fund \$29.47

CASPER WINNELSON - ALL DEPARTMENTS \$29.47

CASPER WINNELSON CO

CASPER WINNELSON CO Balefill - Disposal & Landfill Supplies to replace boiler pump at Miller Ho \$188.12

CASPER WINNELSON CO - Total For Balefill - Disposal & Landfill \$188.12

CASPER WINNELSON CO Buildings & Structures Fund Plumbing repair supplies for City Hall \$26.28

CASPER WINNELSON CO Buildings & Structures Fund Plumbing repair supplies for Ice Arena - Winn \$110.35

CASPER WINNELSON CO Buildings & Structures Fund HVAC Supplies for Metro Animal Shelter - Wi \$764.20

CASPER WINNELSON CO Buildings & Structures Fund HVAC Supplies for Metro Animal Shelter - Wi \$409.40

CASPER WINNELSON CO Buildings & Structures Fund Pool repair parts for Mike Sedar Pool - Winn \$98.30

CASPER WINNELSON CO Buildings & Structures Fund Plumbing repair supplies for the CBC - Winne \$48.96

CASPER WINNELSON CO Buildings & Structures Fund Ice maker installation supplies for Fire 1 - Wi \$12.44

CASPER WINNELSON CO Buildings & Structures Fund Plumbing repair supplies for City Hall - Winne \$180.35

CASPER WINNELSON CO Buildings & Structures Fund Ice Maker installation supplies for Fire 1 - Wi \$86.43

CASPER WINNELSON CO Buildings & Structures Fund Plumbing repair supplies for Fire Station 1 - \$64.74

CASPER WINNELSON CO - Total For Buildings & Structures Fund \$1,801.45

CASPER WINNELSON CO - ALL DEPARTMENTS \$1,989.57

CENTRAL PAINT & BODY

CENTRAL PAINT & BODY Fleet Maintenance Fund Auto body repair \$356.60

CENTRAL PAINT & BODY - Total For Fleet Maintenance Fund \$356.60

CENTRAL PAINT & BODY - ALL DEPARTMENTS \$356.60

CENTRAL TRUCK & DIES

CENTRAL TRUCK & DIES	Fleet Maintenance Fund	Vehicle repair	\$5,114.12
<i>CENTRAL TRUCK & DIES - Total For Fleet Maintenance Fund</i>			\$5,114.12
CENTRAL TRUCK & DIES - ALL DEPARTMENTS			\$5,114.12

CENTURYLINK

CENTURYLINK	Fleet Maintenance Fund	Acct #P-307-111-5112 611M	\$176.64
<i>CENTURYLINK - Total For Fleet Maintenance Fund</i>			\$176.64
CENTURYLINK	Public Safety Communication	Acct #P-307-234-8116 403M	\$156.10
<i>CENTURYLINK - Total For Public Safety Communications</i>			\$156.10
CENTURYLINK	Rec Center - Operations	Acct #P-307-111-5114 622M	\$346.86
<i>CENTURYLINK - Total For Rec Center - Operations</i>			\$346.86
CENTURYLINK	WWTP Operations	Acct #P-307-111-5113 619M	\$96.32
<i>CENTURYLINK - Total For WWTP Operations</i>			\$96.32
CENTURYLINK	WWTP Regional Interceptors	Acct #307-472-1129 839B	\$61.35
<i>CENTURYLINK - Total For WWTP Regional Interceptors</i>			\$61.35
CENTURYLINK - ALL DEPARTMENTS			\$837.27

CHAPMAN VALDEZ & LAN

CHAPMAN VALDEZ & LAN	City Manager	Court Appointed Attorney - Municipal Court	\$2,000.00
CHAPMAN VALDEZ & LAN	City Manager	Court Appointed Attorney - Municipal Court	\$2,000.00
CHAPMAN VALDEZ & LAN	City Manager	Court Appointed Attorney Servi	\$2,000.00
<i>CHAPMAN VALDEZ & LAN - Total For City Manager</i>			\$6,000.00
CHAPMAN VALDEZ & LAN - ALL DEPARTMENTS			\$6,000.00

CHARTER COMMUNICATIO

CHARTER COMMUNICATIO	Golf - Operations	Cable for clubhouse	\$225.62
<i>CHARTER COMMUNICATIO - Total For Golf - Operations</i>			\$225.62
CHARTER COMMUNICATIO - ALL DEPARTMENTS			\$225.62

CHEM AQUA

CHEM AQUA	Ice Arena - Operations	Chem Aqua - Water Treatment	\$489.83
-----------	------------------------	-----------------------------	----------

CHEM AQUA - Total For Ice Arena - Operations \$489.83

CHEM AQUA - ALL DEPARTMENTS \$489.83

CINDY PRITCHARD

CINDY PRITCHARD General Fund Revenue Souvenirs for resale in museum store \$71.40

CINDY PRITCHARD - Total For General Fund Revenue \$71.40

CINDY PRITCHARD - ALL DEPARTMENTS \$71.40

CITIZEN PAYMENT

CITIZEN PAYMENT Aquatics- Mike Sedar Oper. 8/26/22 Cancelled Pool Party Refund \$690.00

CITIZEN PAYMENT - Total For Aquatics- Mike Sedar Oper. \$690.00

CITIZEN PAYMENT City Attorney Processor Fees-Case #20-039322/Docket #2 \$100.00

CITIZEN PAYMENT - Total For City Attorney \$100.00

CITIZEN PAYMENT Rec Center 9/24/22 Cancelled Softball Tournament Refu \$225.00

CITIZEN PAYMENT - Total For Rec Center \$225.00

CITIZEN PAYMENT - ALL DEPARTMENTS \$1,015.00

CITY OF CASPER

CITY OF CASPER Parks - Athletic Maint. Commercial Charge - 4 YD Container \$384.00

CITY OF CASPER Parks - Athletic Maint. Commercial Charge - 6 YD Container \$172.00

CITY OF CASPER Parks - Athletic Maint. Commercial Charge - 6 YD Container \$119.00

CITY OF CASPER - Total For Parks - Athletic Maint. \$675.00

CITY OF CASPER Refuse - Residential Garbage baler/street sweeping/newspaper/c \$7,509.80

CITY OF CASPER Refuse - Residential Garbage baler/street sweeping/newspaper/c \$11,726.10

CITY OF CASPER Refuse - Residential Garbage baler & recycle cardboard \$6,564.24

CITY OF CASPER Refuse - Residential Garbage baler & recycle cardboard \$7,204.99

CITY OF CASPER Refuse - Residential Garbage baler & recycle cardboard \$7,596.47

CITY OF CASPER Refuse - Residential Garbage baler & recycle cardboard \$613.44

CITY OF CASPER Refuse - Residential Garbage baler & recycle newspaper/cardboa \$6,783.50

CITY OF CASPER Refuse - Residential Garbage baler & recycle cardboard \$7,074.00

CITY OF CASPER Refuse - Residential Garbage baler & recycle newspaper/cardboa \$7,632.92

CITY OF CASPER Refuse - Residential Garbage baler, recycle cardboard/magazines \$6,824.56

CITY OF CASPER Refuse - Residential Garbage baler & recycle cardboard \$591.30

CITY OF CASPER	Refuse - Residential	Garbage baler & recycle newspaper/cardboa	\$6,531.07
CITY OF CASPER	Refuse - Residential	Garbage baler & recycle cardboard	\$608.04
<i>CITY OF CASPER - Total For Refuse - Residential</i>			<i>\$77,260.43</i>
CITY OF CASPER	Sewer Administration	201 Sewer RWWS	\$416,189.28
<i>CITY OF CASPER - Total For Sewer Administration</i>			<i>\$416,189.28</i>
CITY OF CASPER	Social Community Services	Ballfield user fee	\$393.75
CITY OF CASPER	Social Community Services	Residential charge	\$69.00
CITY OF CASPER	Social Community Services	Ballfield user fee	\$568.75
CITY OF CASPER	Social Community Services	Commercial charge - 6 YD container	\$69.00
<i>CITY OF CASPER - Total For Social Community Services</i>			<i>\$1,100.50</i>
CITY OF CASPER	WWTP Operations	Sump Sludge/Honey Wagon	\$93.42
CITY OF CASPER	WWTP Operations	Sump Sludge/Honey Wagon	\$112.59
CITY OF CASPER	WWTP Operations	Sump Sludge/Honey Wagon	\$78.84
CITY OF CASPER	WWTP Operations	Sump Sludge/Honey Wagon	\$145.26
CITY OF CASPER	WWTP Operations	Sump Sludge/Honey Wagon	\$84.24
<i>CITY OF CASPER - Total For WWTP Operations</i>			<i>\$514.35</i>
CITY OF CASPER - ALL DEPARTMENTS			\$495,739.56

CIVIL ENGINEERING PR

CIVIL ENGINEERING PR	Capital Projects Fund	I-25 and Casper Marginal Beaut	\$14,922.50
<i>CIVIL ENGINEERING PR - Total For Capital Projects Fund</i>			<i>\$14,922.50</i>
CIVIL ENGINEERING PR - ALL DEPARTMENTS			\$14,922.50

CMI TECO, INC.

CMI TECO, INC.	Balefill - Disposal & Landfill	Equipment repair	\$1,228.80
<i>CMI TECO, INC. - Total For Balefill - Disposal & Landfill</i>			<i>\$1,228.80</i>
CMI TECO, INC.	Refuse - Commercial	Equipment repair	\$1,062.27
CMI TECO, INC.	Refuse - Commercial	Equipment repair	\$1,807.19
CMI TECO, INC.	Refuse - Commercial	Equipment repair	\$2,748.36
CMI TECO, INC.	Refuse - Commercial	Equipment repair	\$1,509.12
CMI TECO, INC.	Refuse - Commercial	Equipment repair	\$3,830.73
CMI TECO, INC.	Refuse - Commercial	Equipment repair	\$400.72
<i>CMI TECO, INC. - Total For Refuse - Commercial</i>			<i>\$11,358.39</i>
CMI TECO, INC.	Refuse - Recycling	Equipment repair	\$2,332.63

<i>CMI TECO, INC. - Total For Refuse - Recycling</i>			<i>\$2,332.63</i>
CMI TECO, INC.	Refuse - Residential	Equipment repair	\$911.46
CMI TECO, INC.	Refuse - Residential	Cylinder dump arm	\$1,755.72
CMI TECO, INC.	Refuse - Residential	Equipment repair	\$3,025.96
CMI TECO, INC.	Refuse - Residential		\$336.47
CMI TECO, INC.	Refuse - Residential	Equipment repair	\$3,969.47
CMI TECO, INC.	Refuse - Residential	Equipment repair	\$343.47
CMI TECO, INC.	Refuse - Residential	Cab lift cylinder	\$251.16
<i>CMI TECO, INC. - Total For Refuse - Residential</i>			<i>\$10,593.71</i>
CMI TECO, INC. - ALL DEPARTMENTS			\$25,513.53

COASTAL CHEMICAL CO

COASTAL CHEMICAL CO	Regional Water Operations	Unleaded fuel	\$101.98
<i>COASTAL CHEMICAL CO - Total For Regional Water Operations</i>			<i>\$101.98</i>
COASTAL CHEMICAL CO - ALL DEPARTMENTS			\$101.98

COMMUNICATION TECHNO

COMMUNICATION TECHNO	Police Administration	Rewired battery separator & rear breakers	\$110.00
COMMUNICATION TECHNO	Police Administration	Code plug repair	\$55.00
COMMUNICATION TECHNO	Police Administration	Clip repair	\$55.00
COMMUNICATION TECHNO	Police Administration	Body camera doc replacement	\$55.00
COMMUNICATION TECHNO	Police Administration	Radio repair	\$110.00
COMMUNICATION TECHNO	Police Administration	Hub charger & shipping cost	\$23.64
<i>COMMUNICATION TECHNO - Total For Police Administration</i>			<i>\$408.64</i>
COMMUNICATION TECHNO	Risk Management	Cage camera & mount replacement	\$110.00
<i>COMMUNICATION TECHNO - Total For Risk Management</i>			<i>\$110.00</i>
COMMUNICATION TECHNO - ALL DEPARTMENTS			\$518.64

COMTRONIX, INC.

COMTRONIX, INC.	Fleet Maintenance Fund	Alarm monitoring & radio service	\$183.00
<i>COMTRONIX, INC. - Total For Fleet Maintenance Fund</i>			<i>\$183.00</i>
COMTRONIX, INC.	Ft. Caspar Museum	Alarm monitoring & radio service	\$534.00
<i>COMTRONIX, INC. - Total For Ft. Caspar Museum</i>			<i>\$534.00</i>

COMTRONIX, INC. - ALL DEPARTMENTS \$717.00

CONOCO - BAIRS TRUCK

CONOCO - BAIRS TRUCK Police Career Services AUTOMATED FUEL DISPENSERS \$51.99

CONOCO - BAIRS TRUCK - Total For Police Career Services \$51.99

CONOCO - BAIRS TRUCK - ALL DEPARTMENTS \$51.99

CONOCO - CONOMART IV

CONOCO - CONOMART IV Police Career Services AUTOMATED FUEL DISPENSERS \$14.72

CONOCO - CONOMART IV - Total For Police Career Services \$14.72

CONOCO - CONOMART IV - ALL DEPARTMENTS \$14.72

CONVERGEONE

CONVERGEONE Information Services Annual Maintenance / Managed Services \$17,229.00

CONVERGEONE - Total For Information Services \$17,229.00

CONVERGEONE - ALL DEPARTMENTS \$17,229.00

COURSRA70EBDWK3Y3XUT

COURSRA70EBDWK3Y3XUT Public Transit - CARES Act Assignment #4 Coursera \$49.00

COURSRA70EBDWK3Y3XUT - Total For Public Transit - CARES Act \$49.00

COURSRA70EBDWK3Y3XUT - ALL DEPARTMENTS \$49.00

CPU IIT

CPU IIT Fire-EMS Administration Panasonic Tough Book for BR2 \$2,807.70

CPU IIT - Total For Fire-EMS Administration \$2,807.70

CPU IIT - ALL DEPARTMENTS \$2,807.70

CRIME SCENE INFORMAT

CRIME SCENE INFORMAT Police Administration Basic program / Web tips - October 2022 \$122.00

CRIME SCENE INFORMAT - Total For Police Administration \$122.00

CRIME SCENE INFORMAT - ALL DEPARTMENTS \$122.00

CRITICAL RESPONSE GR

CRITICAL RESPONSE GR Public Safety Communication 911 Eye Emergency Streaming Software & Tr \$14,900.00

CRITICAL RESPONSE GR - Total For Public Safety Communications \$14,900.00

CRITICAL RESPONSE GR - ALL DEPARTMENTS \$14,900.00

CROWN CONSTRUCTION L

CROWN CONSTRUCTION L Capital Projects Fund 2022 Storm Sewer Upgrades - 1s \$15,523.00

CROWN CONSTRUCTION L - Total For Capital Projects Fund \$15,523.00

CROWN CONSTRUCTION L - ALL DEPARTMENTS \$15,523.00

CRUM ELECTRIC SUPPLY

CRUM ELECTRIC SUPPLY Buildings & Structures Fund Septic Tank repair supplies for Stuckenhoff - \$106.04

CRUM ELECTRIC SUPPLY Buildings & Structures Fund Lighting repair supplies for Crossroads Pavilli \$65.00

CRUM ELECTRIC SUPPLY Buildings & Structures Fund Repair supplies for Rec Center - Crum \$13.22

CRUM ELECTRIC SUPPLY - Total For Buildings & Structures Fund \$184.26

CRUM ELECTRIC SUPPLY Regional Water Operations Actiflo Project Parts - Machinery Supplies \$265.70

CRUM ELECTRIC SUPPLY - Total For Regional Water Operations \$265.70

CRUM ELECTRIC SUPPLY RWS - Booster Stations Lights for Wardwell Tank Booster Supplies \$60.20

CRUM ELECTRIC SUPPLY RWS - Booster Stations Lightbulbs for Wardwell Tank Regional Boost \$15.05

CRUM ELECTRIC SUPPLY - Total For RWS - Booster Stations \$75.25

CRUM ELECTRIC SUPPLY - ALL DEPARTMENTS \$525.21

Cunningham Electric

Cunningham Electric Regional Water Operations Installation of Dryer & Ice Maker - Maint./Re \$2,175.00

Cunningham Electric - Total For Regional Water Operations \$2,175.00

Cunningham Electric - ALL DEPARTMENTS \$2,175.00

DANA KEPNER CO. OF W

DANA KEPNER CO. OF W WWTP Operations 36" repair clamp \$5,719.71

DANA KEPNER CO. OF W - Total For WWTP Operations \$5,719.71

DANA KEPNER CO. OF W - ALL DEPARTMENTS

\$5,719.71

DANA KEPNER COMPANY

DANA KEPNER COMPANY	RWS - Booster Stations	12" Sleeves Salt Creek Fire Hydrant Move	\$1,285.42
---------------------	------------------------	--	------------

DANA KEPNER COMPANY	RWS - Booster Stations	3" 300# Full Face Red Rubber Flange Gasket	\$76.00
---------------------	------------------------	--	---------

<i>DANA KEPNER COMPANY - Total For RWS - Booster Stations</i>			\$1,361.42
---	--	--	------------

DANA KEPNER COMPANY	Water Distribution	6" Clamp Water Sewerline Materials	\$962.36
---------------------	--------------------	------------------------------------	----------

DANA KEPNER COMPANY	Water Distribution	8x8x8 PVC Tee Water & Sewer Line Materials	\$930.50
---------------------	--------------------	--	----------

<i>DANA KEPNER COMPANY - Total For Water Distribution</i>			\$1,892.86
---	--	--	------------

DANA KEPNER COMPANY	Water Tanks	1/2" Air Vac Valve Mt Road Booster ARVP 20	\$840.00
---------------------	-------------	--	----------

<i>DANA KEPNER COMPANY - Total For Water Tanks</i>			\$840.00
--	--	--	----------

DANA KEPNER COMPANY - ALL DEPARTMENTS

\$4,094.28

DBC IRRIGATION SUPPL

DBC IRRIGATION SUPPL	Capital Projects Fund	New hydrometer for irrigation system at We	\$1,928.17
----------------------	-----------------------	--	------------

DBC IRRIGATION SUPPL	Capital Projects Fund	Rebuild parts for backflow preventer at West	\$1,466.56
----------------------	-----------------------	--	------------

<i>DBC IRRIGATION SUPPL - Total For Capital Projects Fund</i>			\$3,394.73
---	--	--	------------

DBC IRRIGATION SUPPL	Parks - Athletic Maint.	Soccer Field 10 Swing Joint	\$42.49
----------------------	-------------------------	-----------------------------	---------

<i>DBC IRRIGATION SUPPL - Total For Parks - Athletic Maint.</i>			\$42.49
---	--	--	---------

DBC IRRIGATION SUPPL - ALL DEPARTMENTS

\$3,437.22

DECKER AUTO GLASS, I

DECKER AUTO GLASS, I	Fire-EMS Operations	Valve, brush, soap & wooden handle	\$473.89
----------------------	---------------------	------------------------------------	----------

<i>DECKER AUTO GLASS, I - Total For Fire-EMS Operations</i>			\$473.89
---	--	--	----------

DECKER AUTO GLASS, I	Fleet Maintenance Fund	Auto glass repair	\$363.14
----------------------	------------------------	-------------------	----------

DECKER AUTO GLASS, I	Fleet Maintenance Fund	Auto glass repair	\$537.57
----------------------	------------------------	-------------------	----------

<i>DECKER AUTO GLASS, I - Total For Fleet Maintenance Fund</i>			\$900.71
--	--	--	----------

DECKER AUTO GLASS, I - ALL DEPARTMENTS

\$1,374.60

DENNIS SUPPLY CO.

DENNIS SUPPLY CO.	Buildings & Structures Fund	HVAC Repair supplies for CBC - Dennis Suppl	\$438.96
-------------------	-----------------------------	---	----------

DENNIS SUPPLY CO.	Buildings & Structures Fund	BAS Shop Supplies - Dennis Supply	\$49.44
-------------------	-----------------------------	-----------------------------------	---------

DENNIS SUPPLY CO.	Buildings & Structures Fund	HVAC Supplies for Aquatics Center - Dennis S	\$22.59
-------------------	-----------------------------	--	---------

DENNIS SUPPLY CO.	Buildings & Structures Fund	HVAC Repair supplies for Aquatics Center - D	\$20.19
DENNIS SUPPLY CO.	Buildings & Structures Fund	Repair supplies for HVAC at Aquatics Center -	\$3,057.58
DENNIS SUPPLY CO.	Buildings & Structures Fund	HVAC Supplies for Aquatics Center - Dennis S	\$598.50
DENNIS SUPPLY CO.	Buildings & Structures Fund	HVAC Supplies for Metro Animal Shelter - De	\$38.35
<i>DENNIS SUPPLY CO. - Total For Buildings & Structures Fund</i>			<i>\$4,225.61</i>
DENNIS SUPPLY CO. - ALL DEPARTMENTS			\$4,225.61

DENVER INDUSTRIAL PU

DENVER INDUSTRIAL PU	WWTP Operations	Paco Shaft Kit	\$2,776.30
<i>DENVER INDUSTRIAL PU - Total For WWTP Operations</i>			<i>\$2,776.30</i>
DENVER INDUSTRIAL PU - ALL DEPARTMENTS			\$2,776.30

DEPT. OF FAMILY SVCS

DEPT. OF FAMILY SVCS	Police Federal Grants	COURT COSTS INCLUDING ALIMONY AND CH	\$10.00
<i>DEPT. OF FAMILY SVCS - Total For Police Federal Grants</i>			<i>\$10.00</i>
DEPT. OF FAMILY SVCS - ALL DEPARTMENTS			\$10.00

DISCOUNTCELL INC

DISCOUNTCELL INC	Fire-EMS Administration	Cradle Point for BR2	\$1,104.75
<i>DISCOUNTCELL INC - Total For Fire-EMS Administration</i>			<i>\$1,104.75</i>
DISCOUNTCELL INC	Public Safety Communication	Cradlepoint for MCV	\$2,512.45
<i>DISCOUNTCELL INC - Total For Public Safety Communications</i>			<i>\$2,512.45</i>
DISCOUNTCELL INC - ALL DEPARTMENTS			\$3,617.20

DOMINO'S 6041

DOMINO'S 6041	Regional Water Operations	Lunch for JPB Meeting - Office Supplies	\$79.44
<i>DOMINO'S 6041 - Total For Regional Water Operations</i>			<i>\$79.44</i>
DOMINO'S 6041 - ALL DEPARTMENTS			\$79.44

DPC INDUSTRIES, INC.

DPC INDUSTRIES, INC.	Regional Water Operations	Sodium Hypochlorite	\$11,297.33
<i>DPC INDUSTRIES, INC. - Total For Regional Water Operations</i>			<i>\$11,297.33</i>

DPC INDUSTRIES, INC. - ALL DEPARTMENTS

\$11,297.33

DRI PRINTRUNNER

DRI PRINTRUNNER	Public Transit - Operations	STATIONERY,OFFICE SUPPLIES,PRINTING AN	\$206.84
-----------------	-----------------------------	--	----------

<i>DRI PRINTRUNNER - Total For Public Transit - Operations</i>			<i>\$206.84</i>
--	--	--	-----------------

DRI PRINTRUNNER - ALL DEPARTMENTS

\$206.84

E & F TOWING TRANSP

E & F TOWING TRANSP	Fleet Maintenance Fund	Vehicle towing	\$350.00
---------------------	------------------------	----------------	----------

E & F TOWING TRANSP	Fleet Maintenance Fund	Vehicle towing	\$65.00
---------------------	------------------------	----------------	---------

E & F TOWING TRANSP	Fleet Maintenance Fund	Vehicle towing	\$75.00
---------------------	------------------------	----------------	---------

<i>E & F TOWING TRANSP - Total For Fleet Maintenance Fund</i>			<i>\$490.00</i>
---	--	--	-----------------

E & F TOWING TRANSP - ALL DEPARTMENTS

\$490.00

E 470 EXPRESS TOLLS

E 470 EXPRESS TOLLS	Police Career Services	TOLLS, ROAD AND BRIDGE FEES	\$13.80
---------------------	------------------------	-----------------------------	---------

<i>E 470 EXPRESS TOLLS - Total For Police Career Services</i>			<i>\$13.80</i>
---	--	--	----------------

E 470 EXPRESS TOLLS - ALL DEPARTMENTS

\$13.80

EATON SALES & SVC.,

EATON SALES & SVC.,	Balefill - Disposal & Landfill	Replace retractor clamps on fuel hoses	\$185.96
---------------------	--------------------------------	--	----------

<i>EATON SALES & SVC., - Total For Balefill - Disposal & Landfill</i>			<i>\$185.96</i>
---	--	--	-----------------

EATON SALES & SVC., - ALL DEPARTMENTS

\$185.96

EDX, INC.

EDX, INC.	City Clerk	SCHOOLS AND EDUCATIONAL SERVICES NOT	\$199.00
-----------	------------	--------------------------------------	----------

<i>EDX, INC. - Total For City Clerk</i>			<i>\$199.00</i>
---	--	--	-----------------

EDX, INC. - ALL DEPARTMENTS

\$199.00

ELITE K-9 INC

ELITE K-9 INC	Police Federal Grants	Muzzle, Garmin & fur saver	\$2,068.55
---------------	-----------------------	----------------------------	------------

<i>ELITE K-9 INC - Total For Police Federal Grants</i>			\$2,068.55
ELITE K-9 INC - ALL DEPARTMENTS			\$2,068.55

EMAINT ENTERPRISES,

EMAINT ENTERPRISES,	WWTP Operations	Maintenance work order subscription	\$5,792.53
<i>EMAINT ENTERPRISES, - Total For WWTP Operations</i>			<i>\$5,792.53</i>
EMAINT ENTERPRISES, - ALL DEPARTMENTS			\$5,792.53

EMERGENCY MEDICAL PH

EMERGENCY MEDICAL PH	Fire-EMS Administration	Dr. Colgan (Emergency Medical	\$1,150.00
<i>EMERGENCY MEDICAL PH - Total For Fire-EMS Administration</i>			<i>\$1,150.00</i>
EMERGENCY MEDICAL PH - ALL DEPARTMENTS			\$1,150.00

EMPLOYEE REIMBURSEME

EMPLOYEE REIMBURSEME	Balefill - Diversion & Special	Work boot reimbursement	\$75.60
EMPLOYEE REIMBURSEME	Balefill - Diversion & Special	Work boot reimbursement	\$150.00
<i>EMPLOYEE REIMBURSEME - Total For Balefill - Diversion & Special</i>			<i>\$225.60</i>
EMPLOYEE REIMBURSEME	Buildings & Structures Fund	Work clothing reimbursement	\$24.98
<i>EMPLOYEE REIMBURSEME - Total For Buildings & Structures Fund</i>			<i>\$24.98</i>
EMPLOYEE REIMBURSEME	Fleet Maintenance Fund	Work tool reimbursement	\$102.84
<i>EMPLOYEE REIMBURSEME - Total For Fleet Maintenance Fund</i>			<i>\$102.84</i>
EMPLOYEE REIMBURSEME	General Fund Revenue	Golf tournament fees refund	\$30.00
EMPLOYEE REIMBURSEME	General Fund Revenue	Golf tournament fees refund	\$30.00
<i>EMPLOYEE REIMBURSEME - Total For General Fund Revenue</i>			<i>\$60.00</i>
EMPLOYEE REIMBURSEME	Parks - Parks Maint.	Work clothing reimbursement	\$96.52
<i>EMPLOYEE REIMBURSEME - Total For Parks - Parks Maint.</i>			<i>\$96.52</i>
EMPLOYEE REIMBURSEME	Refuse - Residential	Work boot reimbursement	\$150.00
<i>EMPLOYEE REIMBURSEME - Total For Refuse - Residential</i>			<i>\$150.00</i>
EMPLOYEE REIMBURSEME	Water Distribution	Work clothing reimbursement	\$140.49
<i>EMPLOYEE REIMBURSEME - Total For Water Distribution</i>			<i>\$140.49</i>
EMPLOYEE REIMBURSEME - ALL DEPARTMENTS			\$800.43

ENERGY LABORATORIES

ENERGY LABORATORIES	Hogadon - Operations	Potable Water Test	\$52.00
<i>ENERGY LABORATORIES - Total For Hogadon - Operations</i>			<i>\$52.00</i>
ENERGY LABORATORIES - ALL DEPARTMENTS			\$52.00

ENERGY LABRATORIES I

ENERGY LABRATORIES I	Regional Water Operations	Aerobic Endospores testing	\$306.00
ENERGY LABRATORIES I	Regional Water Operations	Carbon, Total Organic testing	\$67.00
ENERGY LABRATORIES I	Regional Water Operations	Sample management & disposal fee	\$52.00
ENERGY LABRATORIES I	Regional Water Operations	Carbon, Total Organic testing	\$96.00
<i>ENERGY LABRATORIES I - Total For Regional Water Operations</i>			<i>\$521.00</i>
ENERGY LABRATORIES I	Water Tanks	Bacteria, Public Water Supply testing	\$544.00
ENERGY LABRATORIES I	Water Tanks	Bacteria, SDWA testing	\$84.00
ENERGY LABRATORIES I	Water Tanks	Bacteria, SDWA testing	\$52.00
ENERGY LABRATORIES I	Water Tanks	Bacteria, SDWA testing	\$52.00
ENERGY LABRATORIES I	Water Tanks	Bacteria, SDWA testing	\$84.00
ENERGY LABRATORIES I	Water Tanks	Bacteria, Public Water Supply testing	\$544.00
ENERGY LABRATORIES I	Water Tanks	Bacteria, SDWA testing	\$52.00
ENERGY LABRATORIES I	Water Tanks	Bacteria, SDWA testing	\$52.00
ENERGY LABRATORIES I	Water Tanks	Bacteria, Public Water Supply testing	\$544.00
ENERGY LABRATORIES I	Water Tanks	Bacteria, Public Water Supply testing	\$288.00
ENERGY LABRATORIES I	Water Tanks	Bacteria, SDWA testing	\$52.00
ENERGY LABRATORIES I	Water Tanks	Bacteria, SDWA testing	\$52.00
ENERGY LABRATORIES I	Water Tanks	Bacteria, Public Water Supply testing	\$288.00
ENERGY LABRATORIES I	Water Tanks	Bacteria, SDWA testing	\$160.00
ENERGY LABRATORIES I	Water Tanks	Bacteria, Public Water Supply testing	\$544.00
ENERGY LABRATORIES I	Water Tanks	Bacteria, Public Water Supply testing	\$544.00
ENERGY LABRATORIES I	Water Tanks	Bacteria, SDWA testing	\$160.00
<i>ENERGY LABRATORIES I - Total For Water Tanks</i>			<i>\$4,096.00</i>
ENERGY LABRATORIES I - ALL DEPARTMENTS			\$4,617.00

ENTERPRISE RENT-A-CA

ENTERPRISE RENT-A-CA	Police Career Services	ENTERPRISE RENT-A-CAR	\$314.92
<i>ENTERPRISE RENT-A-CA - Total For Police Career Services</i>			<i>\$314.92</i>

ENTERPRISE RENT-A-CA - ALL DEPARTMENTS \$314.92

ENVIRONMENTAL & CIVI

ENVIRONMENTAL & CIVI Capital Projects Fund Senior Center PL Surveying \$787.50

ENVIRONMENTAL & CIVI - Total For Capital Projects Fund \$787.50

ENVIRONMENTAL & CIVI - ALL DEPARTMENTS \$787.50

EVENT 2022 NEPTUNE

EVENT 2022 NEPTUNE Water Meters 2022 Neptune Connect Meter School Travel/ \$295.00

EVENT 2022 NEPTUNE Water Meters Neptune Connect Meter School Travel/Traini \$295.00

EVENT 2022 NEPTUNE - Total For Water Meters \$590.00

EVENT 2022 NEPTUNE - ALL DEPARTMENTS \$590.00

EXPRESS SERVICES INC

EXPRESS SERVICES INC Customer Service Temp service \$275.40

EXPRESS SERVICES INC Customer Service Temp service \$281.14

EXPRESS SERVICES INC - Total For Customer Service \$556.54

EXPRESS SERVICES INC Public Transit - CARES Act Temp service \$506.40

EXPRESS SERVICES INC Public Transit - CARES Act Temp service \$417.78

EXPRESS SERVICES INC - Total For Public Transit - CARES Act \$924.18

EXPRESS SERVICES INC - ALL DEPARTMENTS \$1,480.72

EXXONMOBIL

EXXONMOBIL Police Career Services SERVICE STATIONS \$6.95

EXXONMOBIL Police Career Services AUTOMATED FUEL DISPENSERS \$28.14

EXXONMOBIL - Total For Police Career Services \$35.09

EXXONMOBIL - ALL DEPARTMENTS \$35.09

FERGUSON ENTERPRISES

FERGUSON ENTERPRISES Buildings & Structures Fund Supplies to clean drains at Midget Football - \$215.19

FERGUSON ENTERPRISES - Total For Buildings & Structures Fund \$215.19

FERGUSON ENTERPRISES Regional Water Operations Turbidity Manifolds - Machinery Supplies \$250.83

<i>FERGUSON ENTERPRISES - Total For Regional Water Operations</i>			<i>\$250.83</i>
FERGUSON ENTERPRISES	RWS - Booster Stations	NRS Gate Valve Sandy Lakes Booster Bypass	\$265.84
<i>FERGUSON ENTERPRISES - Total For RWS - Booster Stations</i>			<i>\$265.84</i>
FERGUSON ENTERPRISES	Water Meters	7 Hydrant Wrenches - Other Materials & Sup	\$298.06
<i>FERGUSON ENTERPRISES - Total For Water Meters</i>			<i>\$298.06</i>
FERGUSON ENTERPRISES - ALL DEPARTMENTS			\$1,029.92

FIRST INTERSTATE BAN

FIRST INTERSTATE BAN	Customer Service	Tamper resistant deposit bags	\$202.50
<i>FIRST INTERSTATE BAN - Total For Customer Service</i>			<i>\$202.50</i>
FIRST INTERSTATE BAN	Ft. Caspar Museum	Tamper resistant deposit bags	\$70.94
<i>FIRST INTERSTATE BAN - Total For Ft. Caspar Museum</i>			<i>\$70.94</i>
FIRST INTERSTATE BAN - ALL DEPARTMENTS			\$273.44

FISHER SCIENTIFIC

FISHER SCIENTIFIC	WWTP Operations	PH BUFFER 6.86	\$94.18
FISHER SCIENTIFIC	WWTP Operations	COMBO LAB GLASSWARE	\$39.21
<i>FISHER SCIENTIFIC - Total For WWTP Operations</i>			<i>\$133.39</i>
FISHER SCIENTIFIC - ALL DEPARTMENTS			\$133.39

GALLS, INC.

GALLS, INC.	Police Career Services	Uniform supplies	\$51.44
GALLS, INC.	Police Career Services	Uniform supplies	\$147.46
GALLS, INC.	Police Career Services	Uniform supplies	\$22.50
GALLS, INC.	Police Career Services	Uniform supplies	\$45.00
<i>GALLS, INC. - Total For Police Career Services</i>			<i>\$266.40</i>
GALLS, INC. - ALL DEPARTMENTS			\$266.40

GAYLORD NATIONAL

GAYLORD NATIONAL	Police Career Services	GAYLORD OPRYLAND	\$283.20
GAYLORD NATIONAL	Police Career Services	GAYLORD OPRYLAND	\$283.20
GAYLORD NATIONAL	Police Career Services	GAYLORD OPRYLAND	\$283.20
<i>GAYLORD NATIONAL - Total For Police Career Services</i>			<i>\$849.60</i>

GAYLORD NATIONAL - ALL DEPARTMENTS \$849.60

G-C BUILDING SUPPLY

G-C BUILDING SUPPLY Balefill - Baler Processing Door repair \$750.55

G-C BUILDING SUPPLY - Total For Balefill - Baler Processing \$750.55

G-C BUILDING SUPPLY - ALL DEPARTMENTS \$750.55

GEOSYNTEC CONSULTANT

GEOSYNTEC CONSULTANT Balefill - Disposal & Landfill Gems S028998-CRL Monitoring & \$9,660.51

GEOSYNTEC CONSULTANT - Total For Balefill - Disposal & Landfill \$9,660.51

GEOSYNTEC CONSULTANT - ALL DEPARTMENTS \$9,660.51

GEOTECH ENVIRONMENTA

GEOTECH ENVIRONMENTA Balefill - Disposal & Landfill Kit, termination, motor lead \$130.29

GEOTECH ENVIRONMENTA - Total For Balefill - Disposal & Landfill \$130.29

GEOTECH ENVIRONMENTA - ALL DEPARTMENTS \$130.29

GOBLE SAMPSON ASSOC.

GOBLE SAMPSON ASSOC. Regional Water Operations Pump & lubricant supplies \$471.42

GOBLE SAMPSON ASSOC. - Total For Regional Water Operations \$471.42

GOBLE SAMPSON ASSOC. - ALL DEPARTMENTS \$471.42

GOLDER ASSOCIATES

GOLDER ASSOCIATES Balefill - Disposal & Landfill 21-012 CRL Cell 1 Close and Ce \$898.01

GOLDER ASSOCIATES Balefill - Disposal & Landfill 21-019 SW Planning and airspac \$2,217.50

GOLDER ASSOCIATES - Total For Balefill - Disposal & Landfill \$3,115.51

GOLDER ASSOCIATES - ALL DEPARTMENTS \$3,115.51

GOLF AND SPORT SOLUT

GOLF AND SPORT SOLUT Golf - Operations 28.8 Ton of USGA sand \$1,833.79

GOLF AND SPORT SOLUT - Total For Golf - Operations \$1,833.79

GOLF AND SPORT SOLUT - ALL DEPARTMENTS

\$1,833.79

GOLF COURSE SUPERINT

GOLF COURSE SUPERINT	Golf - Operations	GCSAA yearly membership for Jason O.	\$430.00
<i>GOLF COURSE SUPERINT - Total For Golf - Operations</i>			<i>\$430.00</i>

GOLF COURSE SUPERINT - ALL DEPARTMENTS

\$430.00

GRAINGER, INC.

GRAINGER, INC.	Buildings & Structures Fund	BAS Shop Supplies - Grainger	\$49.96
<i>GRAINGER, INC. - Total For Buildings & Structures Fund</i>			<i>\$49.96</i>

GRAINGER, INC.	Regional Water Operations	Light bulbs	\$2,016.14
----------------	---------------------------	-------------	------------

GRAINGER, INC.	Regional Water Operations	Plastic sheet	\$332.09
----------------	---------------------------	---------------	----------

GRAINGER, INC.	Regional Water Operations	Heater & thermostat	\$1,757.70
----------------	---------------------------	---------------------	------------

GRAINGER, INC.	Regional Water Operations	Sewage ejector pump	\$1,202.31
----------------	---------------------------	---------------------	------------

<i>GRAINGER, INC. - Total For Regional Water Operations</i>			<i>\$5,308.24</i>
---	--	--	-------------------

GRAINGER, INC.	Water Tanks	Motor for Roof Vent Booster/Lift Station Sup	\$495.10
----------------	-------------	--	----------

<i>GRAINGER, INC. - Total For Water Tanks</i>			<i>\$495.10</i>
---	--	--	-----------------

GRAINGER, INC.	WWTP Operations	Latches	\$55.22
----------------	-----------------	---------	---------

GRAINGER, INC.	WWTP Operations	MINIATURE BULBS	\$10.96
----------------	-----------------	-----------------	---------

GRAINGER, INC.	WWTP Operations	MINIATURE BULBS	\$44.03
----------------	-----------------	-----------------	---------

GRAINGER, INC.	WWTP Operations	ALKALINE BATTERIES AA, 9V	\$20.26
----------------	-----------------	---------------------------	---------

<i>GRAINGER, INC. - Total For WWTP Operations</i>			<i>\$130.47</i>
---	--	--	-----------------

GRAINGER, INC. - ALL DEPARTMENTS

\$5,983.77

GRANDVIEW PUBLISHIN

GRANDVIEW PUBLISHIN	General Fund Revenue	Books for resale in museum store	\$52.59
---------------------	----------------------	----------------------------------	---------

<i>GRANDVIEW PUBLISHIN - Total For General Fund Revenue</i>			<i>\$52.59</i>
---	--	--	----------------

GRANDVIEW PUBLISHIN - ALL DEPARTMENTS

\$52.59

GREINER MOTOR CO - C

GREINER MOTOR CO - C	Fleet Maintenance Fund	Vehicle repair	\$164.12
----------------------	------------------------	----------------	----------

GREINER MOTOR CO - C	Fleet Maintenance Fund	Vehicle repair	\$152.92
----------------------	------------------------	----------------	----------

<i>GREINER MOTOR CO - C - Total For Fleet Maintenance Fund</i>			<i>\$317.04</i>
--	--	--	-----------------

GREINER MOTOR CO - C - ALL DEPARTMENTS \$317.04

GUS GLOBALSTAR USA

GUS GLOBALSTAR USA Public Safety Communication TELECOMMUNICATION SERV.INCLUD. LOCAL \$218.80

GUS GLOBALSTAR USA - Total For Public Safety Communications \$218.80

GUS GLOBALSTAR USA - ALL DEPARTMENTS \$218.80

HACH CO., CORP.

HACH CO., CORP. Regional Water Operations Ammonia Monochloramine \$330.98

HACH CO., CORP. Regional Water Operations Sample Cell Lab Kit - Lab Supplies \$214.08

HACH CO., CORP. - Total For Regional Water Operations \$545.06

HACH CO., CORP. - ALL DEPARTMENTS \$545.06

HAJOCA KEENAN SUPP

HAJOCA KEENAN SUPP RWS - Booster Stations 300 CS RF Blind FLNG Sandy Lakes Booster B \$103.22

HAJOCA KEENAN SUPP - Total For RWS - Booster Stations \$103.22

HAJOCA KEENAN SUPP - ALL DEPARTMENTS \$103.22

HAMPTON INNS

HAMPTON INNS Police Career Services HAMPTON INNS HOTELS \$310.25

HAMPTON INNS Police Career Services HAMPTON INNS HOTELS \$487.78

HAMPTON INNS - Total For Police Career Services \$798.03

HAMPTON INNS - ALL DEPARTMENTS \$798.03

HARBOR FREIGHT TOOLS

HARBOR FREIGHT TOOLS Buildings & Structures Fund BAS Shop Supplies - Harbor Freight \$140.97

HARBOR FREIGHT TOOLS - Total For Buildings & Structures Fund \$140.97

HARBOR FREIGHT TOOLS - ALL DEPARTMENTS \$140.97

HARDWARE PARTNERS LL

HARDWARE PARTNERS LL Hogadon - Operations Lift repair \$13.77

<i>HARDWARE PARTNERS LL - Total For Hogadon - Operations</i>			\$13.77
HARDWARE PARTNERS LL	Parks - Special Areas	Pruners	\$51.98
HARDWARE PARTNERS LL	Parks - Special Areas	leaf blower	\$299.94
<i>HARDWARE PARTNERS LL - Total For Parks - Special Areas</i>			\$351.92
HARDWARE PARTNERS LL	Regional Water Operations	Nipples for Well Field Manifolds - Well Suppli	\$33.97
HARDWARE PARTNERS LL	Regional Water Operations	Tool Room Supplies - Small Tools & Supplies	\$55.98
<i>HARDWARE PARTNERS LL - Total For Regional Water Operations</i>			\$89.95
HARDWARE PARTNERS LL	Water Distribution	Ace Hardware HP Engine Oil Other Materials	\$33.48
<i>HARDWARE PARTNERS LL - Total For Water Distribution</i>			\$33.48
HARDWARE PARTNERS LL	Water Tanks	Nipples for Pratt, Lights/Office Booster/Lift S	\$19.57
<i>HARDWARE PARTNERS LL - Total For Water Tanks</i>			\$19.57
HARDWARE PARTNERS LL	Weed & Pest Fund	chainsaw repair	\$105.58
HARDWARE PARTNERS LL	Weed & Pest Fund	Parts for shed	\$17.98
<i>HARDWARE PARTNERS LL - Total For Weed & Pest Fund</i>			\$123.56
HARDWARE PARTNERS LL - ALL DEPARTMENTS			\$632.25

HDR ENGINEERING, INC

HDR ENGINEERING, INC	Balefill - Disposal & Landfill	Leachate Control Panel	\$4,392.00
<i>HDR ENGINEERING, INC - Total For Balefill - Disposal & Landfill</i>			\$4,392.00
HDR ENGINEERING, INC - ALL DEPARTMENTS			\$4,392.00

HENSLEY BATTERY CASP

HENSLEY BATTERY CASP	WWTP Operations	UPS FOR INVENTORY	\$130.92
<i>HENSLEY BATTERY CASP - Total For WWTP Operations</i>			\$130.92
HENSLEY BATTERY CASP - ALL DEPARTMENTS			\$130.92

HERCULES INDUSTRIES

HERCULES INDUSTRIES	Risk Management	Repair supplies for Washington Park Vandalis	\$20.43
<i>HERCULES INDUSTRIES - Total For Risk Management</i>			\$20.43
HERCULES INDUSTRIES - ALL DEPARTMENTS			\$20.43

HILTON HOTELS

HILTON HOTELS	Police Career Services	HILTON GARDEN INN	\$314.37
---------------	------------------------	-------------------	----------

HILTON HOTELS - Total For Police Career Services \$314.37

HILTON HOTELS - ALL DEPARTMENTS \$314.37

HOLIDAY INN - RIVERT

HOLIDAY INN - RIVERT Police Career Services HOLIDAY INNS \$480.00

HOLIDAY INN - RIVERT - Total For Police Career Services \$480.00

HOLIDAY INN - RIVERT - ALL DEPARTMENTS \$480.00

HOLLAND & HART LLP

HOLLAND & HART LLP Water Tanks Renegotiation of Water Storage \$624.00

HOLLAND & HART LLP - Total For Water Tanks \$624.00

HOLLAND & HART LLP - ALL DEPARTMENTS \$624.00

HOMAX OIL SALES, INC

HOMAX OIL SALES, INC Balefill - Disposal & Landfill Blue DEF \$986.88

HOMAX OIL SALES, INC Balefill - Disposal & Landfill Transmission fluid, oil & drum deposit \$1,296.75

HOMAX OIL SALES, INC - Total For Balefill - Disposal & Landfill \$2,283.63

HOMAX OIL SALES, INC Fleet Maintenance Fund Diesel fuel \$33,966.37

HOMAX OIL SALES, INC Fleet Maintenance Fund Unleaded fuel \$24,890.55

HOMAX OIL SALES, INC - Total For Fleet Maintenance Fund \$58,856.92

HOMAX OIL SALES, INC Golf - Operations Gas and Diesel \$4,467.08

HOMAX OIL SALES, INC - Total For Golf - Operations \$4,467.08

HOMAX OIL SALES, INC - ALL DEPARTMENTS \$65,607.63

HOMEDEPOT.COM

HOMEDEPOT.COM Balefill - Disposal & Landfill ICE MAKER EQUIPMENT BLDG \$459.00

HOMEDEPOT.COM - Total For Balefill - Disposal & Landfill \$459.00

HOMEDEPOT.COM Regional Water Operations Tax Credit for Previous Order - Small Tools & (\$2.45)

HOMEDEPOT.COM - Total For Regional Water Operations (\$2.45)

HOMEDEPOT.COM - ALL DEPARTMENTS \$456.55

HOSE & RUBBER SUPPLY

HOSE & RUBBER SUPPLY	Balefill - Baler Processing	Air hose replacement	\$221.00
<i>HOSE & RUBBER SUPPLY - Total For Balefill - Baler Processing</i>			<i>\$221.00</i>
HOSE & RUBBER SUPPLY - ALL DEPARTMENTS			\$221.00

HOSE AND RUBBER SUPP

HOSE AND RUBBER SUPP	Balefill - Baler Processing	REPLACEMENT OF DAMAGED AIRLINES IN BA	\$196.92
HOSE AND RUBBER SUPP	Balefill - Baler Processing	HOSE REPAIR FOR BALER BUILDING	\$8.26
<i>HOSE AND RUBBER SUPP - Total For Balefill - Baler Processing</i>			<i>\$205.18</i>
HOSE AND RUBBER SUPP	WWTP Operations	BLOWER 1 BELTS	\$146.00
<i>HOSE AND RUBBER SUPP - Total For WWTP Operations</i>			<i>\$146.00</i>
HOSE AND RUBBER SUPP - ALL DEPARTMENTS			\$351.18

HUB INTL. MOUNTAIN S

HUB INTL. MOUNTAIN S	Property Insurance Fund	2021-22 GL Final Self Audit	\$2,282.00
<i>HUB INTL. MOUNTAIN S - Total For Property Insurance Fund</i>			<i>\$2,282.00</i>
HUB INTL. MOUNTAIN S - ALL DEPARTMENTS			\$2,282.00

INGRAM BOOK COMPANY

INGRAM BOOK COMPANY	General Fund Revenue	Books for resale in museum store	\$419.47
<i>INGRAM BOOK COMPANY - Total For General Fund Revenue</i>			<i>\$419.47</i>
INGRAM BOOK COMPANY - ALL DEPARTMENTS			\$419.47

INSITUFORM TECHNOLOG

INSITUFORM TECHNOLOG	Water Revenue and Transfers Retainage - Contract #22300208		\$8,125.00
<i>INSITUFORM TECHNOLOG - Total For Water Revenue and Transfers</i>			<i>\$8,125.00</i>
INSITUFORM TECHNOLOG	WWTP Operations	N Platte Sanitary Sewer Rehab	\$154,375.00
<i>INSITUFORM TECHNOLOG - Total For WWTP Operations</i>			<i>\$154,375.00</i>
INSITUFORM TECHNOLOG - ALL DEPARTMENTS			\$162,500.00

INTERNATIONAL INSTIT

INTERNATIONAL INSTIT	City Clerk	BUSINESS SERVICES NOT ELSEWHERE CLASSI	\$255.00
<i>INTERNATIONAL INSTIT - Total For City Clerk</i>			<i>\$255.00</i>

INTERNATIONAL INSTIT - ALL DEPARTMENTS \$255.00

INTRADO INTERACTIVE

INTRADO INTERACTIVE Information Services Civiclive 2022-23 Maintenance Renewal ww \$4,500.00

INTRADO INTERACTIVE - Total For Information Services \$4,500.00

INTRADO INTERACTIVE - ALL DEPARTMENTS \$4,500.00

INTUIT, INC.

INTUIT, INC. Balefill - Disposal & Landfill CLEANCLUB 307 MISC JANITOR SERVICES \$975.00

INTUIT, INC. - Total For Balefill - Disposal & Landfill \$975.00

INTUIT, INC. - ALL DEPARTMENTS \$975.00

J.J. KELLER & ASSOCI

J.J. KELLER & ASSOCI Risk Management Workplace safety alert 3 yr subscription \$689.00

J.J. KELLER & ASSOCI - Total For Risk Management \$689.00

J.J. KELLER & ASSOCI - ALL DEPARTMENTS \$689.00

JOHNNY JS DINER

JOHNNY JS DINER WWTP Operations LUNCH LMCCARTNEY \$13.94

JOHNNY JS DINER - Total For WWTP Operations \$13.94

JOHNNY JS DINER - ALL DEPARTMENTS \$13.94

JONAS SOFTWARE USA

JONAS SOFTWARE USA Golf - Operations Maintenance Fee \$349.00

JONAS SOFTWARE USA - Total For Golf - Operations \$349.00

JONAS SOFTWARE USA - ALL DEPARTMENTS \$349.00

KARCHER NORTH AMERIC

KARCHER NORTH AMERIC WWTP Operations Hotsy pressure washer \$314.58

KARCHER NORTH AMERIC - Total For WWTP Operations \$314.58

KARCHER NORTH AMERIC - ALL DEPARTMENTS

\$314.58

KETEL THORSTENSON, L

KETEL THORSTENSON, L	Finance	Audit services & postage expense	\$11,515.96
----------------------	---------	----------------------------------	-------------

<i>KETEL THORSTENSON, L - Total For Finance</i>			\$11,515.96
---	--	--	-------------

KETEL THORSTENSON, L - ALL DEPARTMENTS

\$11,515.96

KINSCO LLC

KINSCO LLC	Fire-EMS Operations	Fire Department Uniforms	\$132.25
KINSCO LLC	Fire-EMS Operations	Fire Department Uniforms	\$171.00
KINSCO LLC	Fire-EMS Operations	Fire Department Uniforms	\$25.99
KINSCO LLC	Fire-EMS Operations	Fire Department Uniforms	\$153.00
KINSCO LLC	Fire-EMS Operations	Fire Department Uniforms	\$45.00
KINSCO LLC	Fire-EMS Operations	Fire Department Uniforms	\$22.50
KINSCO LLC	Fire-EMS Operations	Fire Department Uniforms	\$60.99
KINSCO LLC	Fire-EMS Operations	Fire Department Uniforms	\$50.00
KINSCO LLC	Fire-EMS Operations	Fire Department Uniforms	\$272.50
KINSCO LLC	Fire-EMS Operations	Fire Department Uniforms	\$2,553.00
KINSCO LLC	Fire-EMS Operations	Fire Department Uniforms	\$83.00
KINSCO LLC	Fire-EMS Operations	Fire Department Uniforms	\$430.00
KINSCO LLC	Fire-EMS Operations	Fire Department Uniforms	\$130.00
KINSCO LLC	Fire-EMS Operations	Fire Department Uniforms	\$111.25
KINSCO LLC	Fire-EMS Operations	Fire Department Uniforms	\$4,750.00
KINSCO LLC	Fire-EMS Operations	Fire Department Uniforms	\$160.47
KINSCO LLC	Fire-EMS Operations	Fire Department Uniforms	\$306.99
KINSCO LLC	Fire-EMS Operations	Fire Department Uniforms	\$214.47
KINSCO LLC	Fire-EMS Operations	Fire Department Uniforms	\$304.98
KINSCO LLC	Fire-EMS Operations	Fire Department Uniforms	\$288.99

<i>KINSCO LLC - Total For Fire-EMS Operations</i>			\$10,266.38
---	--	--	-------------

KINSCO LLC - ALL DEPARTMENTS

\$10,266.38

KNIFE RIVER/JTL

KNIFE RIVER/JTL	Public Transit - Operations	Recycled Concrete W Base	\$83.02
-----------------	-----------------------------	--------------------------	---------

<i>KNIFE RIVER/JTL - Total For Public Transit - Operations</i>			<i>\$83.02</i>
KNIFE RIVER/JTL	Streets	1/2" Plant Mix	\$3,627.75
KNIFE RIVER/JTL	Streets	1/2" Plant Mix	\$309.00
KNIFE RIVER/JTL	Streets	1/2" Plant Mix	\$912.75
KNIFE RIVER/JTL	Streets	1/2" Plant Mix	\$764.25
KNIFE RIVER/JTL	Streets	1/2" Plant Mix	\$909.75
<i>KNIFE RIVER/JTL - Total For Streets</i>			<i>\$6,523.50</i>
KNIFE RIVER/JTL - ALL DEPARTMENTS			\$6,606.52

KUBWATER RESOURCES,

KUBWATER RESOURCES,	WWTP Operations	Zetag & surcharge	\$7,804.40
<i>KUBWATER RESOURCES, - Total For WWTP Operations</i>			<i>\$7,804.40</i>
KUBWATER RESOURCES, - ALL DEPARTMENTS			\$7,804.40

LAWSON PRODUCTS INC

LAWSON PRODUCTS INC	Fleet Maintenance Fund	Monthly rental	\$525.00
LAWSON PRODUCTS INC	Fleet Maintenance Fund	Monthly rental	\$375.00
<i>LAWSON PRODUCTS INC - Total For Fleet Maintenance Fund</i>			<i>\$900.00</i>
LAWSON PRODUCTS INC - ALL DEPARTMENTS			\$900.00

LETZS APPLIANCE INC

LETZS APPLIANCE INC	Refuse - Commercial	Portable dishwasher	\$879.00
<i>LETZS APPLIANCE INC - Total For Refuse - Commercial</i>			<i>\$879.00</i>
LETZS APPLIANCE INC - ALL DEPARTMENTS			\$879.00

LIPCO

LIPCO	General Fund Revenue	Assorted souvenirs for resale in museum stor	\$539.37
<i>LIPCO - Total For General Fund Revenue</i>			<i>\$539.37</i>
LIPCO - ALL DEPARTMENTS			\$539.37

LONG BUILDING TECHNO

LONG BUILDING TECHNO	Balefill - Diversion & Special	HVAC relay replacement	\$454.38
----------------------	--------------------------------	------------------------	----------

LONG BUILDING TECHNO - Total For Balefill - Diversion & Special \$454.38

LONG BUILDING TECHNO - ALL DEPARTMENTS \$454.38

LOUS GLOVES

LOUS GLOVES WWTP Operations NITRILE GLOVES XL \$624.00

LOUS GLOVES - Total For WWTP Operations \$624.00

LOUS GLOVES - ALL DEPARTMENTS \$624.00

MCCI, LLC

MCCI, LLC City Clerk Laserfiche Renewal - 11/24/22 to 11/23/23 \$10,522.05

MCCI, LLC - Total For City Clerk \$10,522.05

MCCI, LLC - ALL DEPARTMENTS \$10,522.05

McDonald's 35665

McDonald's 35665 Police Investigations FAST FOOD RESTAURANTS \$65.25

McDonald's 35665 - Total For Police Investigations \$65.25

McDonald's 35665 - ALL DEPARTMENTS \$65.25

MCDONALD'S F7107

MCDONALD'S F7107 Rec Center - Admin WRPA Travel Lunch 9/12/2022-Chrissy \$3.67

MCDONALD'S F7107 - Total For Rec Center - Admin \$3.67

MCDONALD'S F7107 - ALL DEPARTMENTS \$3.67

MENARDS CASPER WY

MENARDS CASPER WY Balefill - Diversion & Special TACK LIFTER FOR PROCESSING PAINT, RATCH \$30.94

MENARDS CASPER WY - Total For Balefill - Diversion & Special \$30.94

MENARDS CASPER WY Buildings & Structures Fund HVAC Repair supplies for Metro Animal Shelt \$29.98

MENARDS CASPER WY Buildings & Structures Fund Plumbing repair supplies for Fire Station 1 - \$63.97

MENARDS CASPER WY - Total For Buildings & Structures Fund \$93.95

MENARDS CASPER WY Regional Water Operations Well Field Parts, Shelf for Laundry Room - M \$150.93

MENARDS CASPER WY - Total For Regional Water Operations \$150.93

MENARDS CASPER WY Water Tanks Erosion Blanket & Silt Sock PV Tank Erosion C \$487.97

MENARDS CASPER WY - Total For Water Tanks \$487.97

MENARDS CASPER WY - ALL DEPARTMENTS \$763.79

MICHAELSFENCE&SUPPLY

MICHAELSFENCE&SUPPLY Fleet Maintenance Fund TROUBLESHOOT ENTRY GATE LOOPS \$330.00

MICHAELSFENCE&SUPPLY - Total For Fleet Maintenance Fund \$330.00

MICHAELSFENCE&SUPPLY WWTP Operations Loop detectors \$506.64

MICHAELSFENCE&SUPPLY WWTP Operations FRONT GATE CANTILEVER ROLLERS (4) \$791.60

MICHAELSFENCE&SUPPLY - Total For WWTP Operations \$1,298.24

MICHAELSFENCE&SUPPLY - ALL DEPARTMENTS \$1,628.24

MIDLAND SCIENTIFIC

MIDLAND SCIENTIFIC WWTP Operations NH3 HIGH RANGE TESTS \$375.50

MIDLAND SCIENTIFIC WWTP Operations Lab supplies shipping fee \$5.00

MIDLAND SCIENTIFIC WWTP Operations N, LO3-N LOW RANGE TESTS \$169.12

MIDLAND SCIENTIFIC WWTP Operations NH3 ULTRA LOW RANGE TESTS \$375.50

MIDLAND SCIENTIFIC - Total For WWTP Operations \$925.12

MIDLAND SCIENTIFIC - ALL DEPARTMENTS \$925.12

MIDWEST LABORATORIES

MIDWEST LABORATORIES Balefill - Diversion & Special Shipping charges - compost sample \$13.00

MIDWEST LABORATORIES - Total For Balefill - Diversion & Special \$13.00

MIDWEST LABORATORIES - ALL DEPARTMENTS \$13.00

ML AUTOMOTIVE

ML AUTOMOTIVE Fleet Maintenance Fund Vehicle alignment \$87.00

ML AUTOMOTIVE Fleet Maintenance Fund Vehicle alignment \$87.00

ML AUTOMOTIVE Fleet Maintenance Fund Vehicle alignment \$87.00

ML AUTOMOTIVE Fleet Maintenance Fund Vehicle alignment \$87.00

ML AUTOMOTIVE Fleet Maintenance Fund Vehicle alignment & air conditioning system \$251.78

ML AUTOMOTIVE Fleet Maintenance Fund Vehicle alignment \$117.00

ML AUTOMOTIVE Fleet Maintenance Fund Vehicle alignment \$157.00

ML AUTOMOTIVE Fleet Maintenance Fund Vehicle alignment \$87.00

ML AUTOMOTIVE	Fleet Maintenance Fund	Vehicle alignment	\$117.00
ML AUTOMOTIVE	Fleet Maintenance Fund	Vehicle alignment	\$157.00
ML AUTOMOTIVE	Fleet Maintenance Fund	Vehicle alignment	\$87.00
ML AUTOMOTIVE	Fleet Maintenance Fund	Vehicle alignment	\$117.00
ML AUTOMOTIVE	Fleet Maintenance Fund	Vehicle alignment	\$182.00
ML AUTOMOTIVE	Fleet Maintenance Fund	Vehicle alignment	\$117.00
<i>ML AUTOMOTIVE - Total For Fleet Maintenance Fund</i>			<i>\$1,737.78</i>
ML AUTOMOTIVE - ALL DEPARTMENTS			\$1,737.78

MO MON TAI INC

MO MON TAI INC	Fire-EMS Prevent & Inspect	TERP Consulting (Fire Protecti	\$362.50
<i>MO MON TAI INC - Total For Fire-EMS Prevent & Inspect</i>			<i>\$362.50</i>
MO MON TAI INC - ALL DEPARTMENTS			\$362.50

MOBILE CONCRETE, INC

MOBILE CONCRETE, INC	Public Transit - Operations	City of Casper 40, Fuel Surcharge & Fiber	\$592.00
<i>MOBILE CONCRETE, INC - Total For Public Transit - Operations</i>			<i>\$592.00</i>
MOBILE CONCRETE, INC - ALL DEPARTMENTS			\$592.00

Monson

Monson	Buildings & Structures Fund	Monthly janitorial service - Sept 1-Sept 30, 2	\$5,862.00
Monson	Buildings & Structures Fund	Monthly janitorial service - Sept 1-Sept 30, 2	\$225.00
<i>Monson - Total For Buildings & Structures Fund</i>			<i>\$6,087.00</i>
Monson - ALL DEPARTMENTS			\$6,087.00

MOTION AND FLOW CONT

MOTION AND FLOW CONT	Balefill - Baler Processing	Hoses	\$178.89
<i>MOTION AND FLOW CONT - Total For Balefill - Baler Processing</i>			<i>\$178.89</i>
MOTION AND FLOW CONT	Refuse - Residential	Hydraulic valve	\$35.15
<i>MOTION AND FLOW CONT - Total For Refuse - Residential</i>			<i>\$35.15</i>
MOTION AND FLOW CONT - ALL DEPARTMENTS			\$214.04

MOTION INDUSTRIES

MOTION INDUSTRIES	Balefill - Baler Processing	LOCK RINGS FOR BALER PINS	\$190.67
<i>MOTION INDUSTRIES - Total For Balefill - Baler Processing</i>			<i>\$190.67</i>
MOTION INDUSTRIES - ALL DEPARTMENTS			\$190.67

MOUNTAIN STATES

MOUNTAIN STATES	City Attorney	Printing service - envelopes	\$106.27
<i>MOUNTAIN STATES - Total For City Attorney</i>			<i>\$106.27</i>
MOUNTAIN STATES	Community Development	Printing service - mechanical work inspect sti	\$197.69
MOUNTAIN STATES	Community Development	Printing service - plumbing inspection door h	\$135.40
<i>MOUNTAIN STATES - Total For Community Development</i>			<i>\$333.09</i>
MOUNTAIN STATES - ALL DEPARTMENTS			\$439.36

MOUNTAIN STATES PIPE

MOUNTAIN STATES PIPE	Water Meters	14 Kamstrup Meters New Meters/ERT's	\$1,988.00
MOUNTAIN STATES PIPE	Water Meters	13 Kamstup Meters/Shipping New Meter & E	\$1,913.12
MOUNTAIN STATES PIPE	Water Meters	100W ENCODR - NEW METERS/ERT'S	\$12,872.00
MOUNTAIN STATES PIPE	Water Meters	13 Kamstrup Meters New Meters & ERT's	\$1,912.83
<i>MOUNTAIN STATES PIPE - Total For Water Meters</i>			<i>\$18,685.95</i>
MOUNTAIN STATES PIPE - ALL DEPARTMENTS			\$18,685.95

MPI WAREHOUSE SPECIA

MPI WAREHOUSE SPECIA	Regional Water Operations	Gauges for Wells - Well Supplies	\$55.13
<i>MPI WAREHOUSE SPECIA - Total For Regional Water Operations</i>			<i>\$55.13</i>
MPI WAREHOUSE SPECIA - ALL DEPARTMENTS			\$55.13

MURDOCH'S RANCH&HOME

MURDOCH'S RANCH&HOM	Balefill - Disposal & Landfill	WOVEN WIRE FENCING RIVER CLEAN UP	\$1,574.85
MURDOCH'S RANCH&HOM	Balefill - Disposal & Landfill	MRIVER CLEAN UP WOVEN WIRE FENCING	\$333.46
<i>MURDOCH'S RANCH&HOME - Total For Balefill - Disposal & Landfill</i>			<i>\$1,908.31</i>
MURDOCH'S RANCH&HOM	Parks - Special Areas	tools	\$171.94
<i>MURDOCH'S RANCH&HOME - Total For Parks - Special Areas</i>			<i>\$171.94</i>

MURDOCH'S RANCH&HOME - ALL DEPARTMENTS \$2,080.25

MVIX (USA), Inc.

MVIX (USA), Inc. Balefill - Disposal & Landfill MESSAGING SOFTWARE \$2,840.00

MVIX (USA), Inc. - Total For Balefill - Disposal & Landfill \$2,840.00

MVIX (USA), Inc. Refuse - Residential MESSAGING SOFTWARE \$1,704.00

MVIX (USA), Inc. - Total For Refuse - Residential \$1,704.00

MVIX (USA), Inc. - ALL DEPARTMENTS \$4,544.00

NAPA AUTO PARTS CORP

NAPA AUTO PARTS CORP Balefill - Disposal & Landfill Brake parts cleaner \$71.76

NAPA AUTO PARTS CORP - Total For Balefill - Disposal & Landfill \$71.76

NAPA AUTO PARTS CORP - ALL DEPARTMENTS \$71.76

NATRONA COUNTY OFFIC

NATRONA COUNTY OFFIC Rec Center - Operations Technician -Dance Recitals \$210.00

NATRONA COUNTY OFFIC - Total For Rec Center - Operations \$210.00

NATRONA COUNTY OFFIC Social Community Services Funds to sustain account balance \$24,209.00

NATRONA COUNTY OFFIC Social Community Services Ice machine replacement \$3,188.50

NATRONA COUNTY OFFIC Social Community Services Water heater/fire prevent backflow/generat \$10,673.73

NATRONA COUNTY OFFIC - Total For Social Community Services \$38,071.23

NATRONA COUNTY OFFIC - ALL DEPARTMENTS \$38,281.23

NJ CRIMINAL INTERDIC

NJ CRIMINAL INTERDIC Police Career Services The gun game \$249.00

NJ CRIMINAL INTERDIC - Total For Police Career Services \$249.00

NJ CRIMINAL INTERDIC - ALL DEPARTMENTS \$249.00

NORCO, INC.

NORCO, INC. Balefill - Baler Processing Welding clothing supplies (shirt, hat, jacket) \$102.80

NORCO, INC. - Total For Balefill - Baler Processing \$102.80

NORCO, INC. Buildings & Structures Fund Custodial Supplies for Ice Arena - Norco \$344.38

<i>NORCO, INC. - Total For Buildings & Structures Fund</i>			<i>\$344.38</i>
NORCO, INC.	Fleet Maintenance Fund	Cylinder rental	\$156.24
<i>NORCO, INC. - Total For Fleet Maintenance Fund</i>			<i>\$156.24</i>
NORCO, INC.	Hogadon - Operations	Lodge and Shop supplies	\$271.59
NORCO, INC.	Hogadon - Operations	Lodge and shop supplies	\$102.52
<i>NORCO, INC. - Total For Hogadon - Operations</i>			<i>\$374.11</i>
NORCO, INC.	Metro Animal Shelter	Liquid soap, air freshener & garbage bags	\$491.10
NORCO, INC.	Metro Animal Shelter	Laundry detergent	\$83.70
<i>NORCO, INC. - Total For Metro Animal Shelter</i>			<i>\$574.80</i>
NORCO, INC.	Water Distribution	Carbon Dioxide Other Materials & Supplies	\$102.36
NORCO, INC.	Water Distribution	Safety Supplies 2010030-6101	\$118.03
<i>NORCO, INC. - Total For Water Distribution</i>			<i>\$220.39</i>
NORCO, INC.	WWTP Operations	Gloves	\$23.24
<i>NORCO, INC. - Total For WWTP Operations</i>			<i>\$23.24</i>
NORCO, INC. - ALL DEPARTMENTS			\$1,795.96

NORTHERN LIGHTS MANU

NORTHERN LIGHTS MANU	Refuse - Residential	Remove / replace AR plate	\$7,200.00
<i>NORTHERN LIGHTS MANU - Total For Refuse - Residential</i>			<i>\$7,200.00</i>
NORTHERN LIGHTS MANU - ALL DEPARTMENTS			\$7,200.00

NORTHWEST CONTRACTOR

NORTHWEST CONTRACTOR	Balefill - Baler Processing	Snow shovels & gloves	\$431.10
<i>NORTHWEST CONTRACTOR - Total For Balefill - Baler Processing</i>			<i>\$431.10</i>
NORTHWEST CONTRACTOR	Balefill - Diversion & Special	Sawzall kit, battery charger & fuel friction to	\$827.00
NORTHWEST CONTRACTOR	Balefill - Diversion & Special	Measuring wheel	\$538.00
<i>NORTHWEST CONTRACTOR - Total For Balefill - Diversion & Special</i>			<i>\$1,365.00</i>
NORTHWEST CONTRACTOR	Buildings & Structures Fund	BAS Shop Supplies - NW Contractors Supply	\$36.39
<i>NORTHWEST CONTRACTOR - Total For Buildings & Structures Fund</i>			<i>\$36.39</i>
NORTHWEST CONTRACTOR	Regional Water Operations	Cutter Bit - Small Tools & Supplies	\$8.02
<i>NORTHWEST CONTRACTOR - Total For Regional Water Operations</i>			<i>\$8.02</i>
NORTHWEST CONTRACTOR	RWS - Booster Stations	Rubber Gasket 2020033-6101 Sandy Booster	\$5.74
<i>NORTHWEST CONTRACTOR - Total For RWS - Booster Stations</i>			<i>\$5.74</i>
NORTHWEST CONTRACTOR	Water Distribution	Aluminum Pipe Wrench's Vehicle Supplies	\$517.24

NORTHWEST CONTRACTOR	Water Distribution	Pin Flags Water & Sewer Line Materials	\$173.52
<i>NORTHWEST CONTRACTOR - Total For Water Distribution</i>			<i>\$690.76</i>
NORTHWEST CONTRACTOR - ALL DEPARTMENTS			\$2,537.01

NORTON NP1416087506

NORTON NP1416087506	Police Administration	COMPUTER SOFTWARE STORES	\$20.99
<i>NORTON NP1416087506 - Total For Police Administration</i>			<i>\$20.99</i>
NORTON NP1416087506 - ALL DEPARTMENTS			\$20.99

NSAA

NSAA	Hogadon - Operations	Annual Due NSAA	\$640.32
<i>NSAA - Total For Hogadon - Operations</i>			<i>\$640.32</i>
NSAA - ALL DEPARTMENTS			\$640.32

NVA CASPER VETERINAR

NVA CASPER VETERINAR	Metro Animal Shelter	Veterinary service	\$235.30
<i>NVA CASPER VETERINAR - Total For Metro Animal Shelter</i>			<i>\$235.30</i>
NVA CASPER VETERINAR	Police Administration	Veterinary service	\$348.81
<i>NVA CASPER VETERINAR - Total For Police Administration</i>			<i>\$348.81</i>
NVA CASPER VETERINAR - ALL DEPARTMENTS			\$584.11

OFFICE DEPOT

OFFICE DEPOT	Customer Service	2 boxes of 100 blank postcards each, 1 yello	\$75.80
<i>OFFICE DEPOT - Total For Customer Service</i>			<i>\$75.80</i>
OFFICE DEPOT	Finance	2 boxes of 100 blank postcards each, 1 yello	\$75.80
<i>OFFICE DEPOT - Total For Finance</i>			<i>\$75.80</i>
OFFICE DEPOT	Health Insurance Fund	2 boxes of 100 blank postcards each, 1 yello	\$75.80
<i>OFFICE DEPOT - Total For Health Insurance Fund</i>			<i>\$75.80</i>
OFFICE DEPOT	Human Resources	2 boxes of 100 blank postcards each, 1 yello	\$95.24
OFFICE DEPOT	Human Resources	1 headset	\$72.24
<i>OFFICE DEPOT - Total For Human Resources</i>			<i>\$167.48</i>
OFFICE DEPOT	Risk Management	2 boxes of 100 blank postcards each, 1 yello	\$75.80
<i>OFFICE DEPOT - Total For Risk Management</i>			<i>\$75.80</i>

OFFICE DEPOT - ALL DEPARTMENTS \$470.68

OHMART/VEGA CORP

OHMART/VEGA CORP WWTP Regional Interceptors BRACKET \$102.00

OHMART/VEGA CORP - Total For WWTP Regional Interceptors \$102.00

OHMART/VEGA CORP - ALL DEPARTMENTS \$102.00

ONESOURCE FIRE RESCU

ONESOURCE FIRE RESCU Fire-EMS Operations Sawzall mount for Rescue 1 \$77.49

ONESOURCE FIRE RESCU - Total For Fire-EMS Operations \$77.49

ONESOURCE FIRE RESCU - ALL DEPARTMENTS \$77.49

OREGON CALIFORNIA TR

OREGON CALIFORNIA TR Ft. Caspar Museum Annual membership \$60.00

OREGON CALIFORNIA TR - Total For Ft. Caspar Museum \$60.00

OREGON CALIFORNIA TR - ALL DEPARTMENTS \$60.00

OVERHEAD DOOR OF CAS

OVERHEAD DOOR OF CAS Capital Projects Fund Roll up door for soccer pump station \$1,379.52

OVERHEAD DOOR OF CAS - Total For Capital Projects Fund \$1,379.52

OVERHEAD DOOR OF CAS - ALL DEPARTMENTS \$1,379.52

PACIFIC STEEL BRANCH

PACIFIC STEEL BRANCH RWS - Booster Stations 72" SCH40 X 21' Sandy Lakes Booster Supplie \$86.78

PACIFIC STEEL BRANCH - Total For RWS - Booster Stations \$86.78

PACIFIC STEEL BRANCH Water Distribution Street Key Tubing Vehicle Supplies \$179.13

PACIFIC STEEL BRANCH - Total For Water Distribution \$179.13

PACIFIC STEEL BRANCH - ALL DEPARTMENTS \$265.91

PEAK GEOSOLUTIONS/ S

PEAK GEOSOLUTIONS/ S Balefill - Disposal & Landfill PSC Peak CQA CRL Cell 5 Const \$38,749.88

PEAK GEOSOLUTIONS/S - Total For Balefill - Disposal & Landfill \$38,749.88

PEAK GEOSOLUTIONS/ S - ALL DEPARTMENTS \$38,749.88

PEDEN'S INC

PEDEN'S INC Balefill - Disposal & Landfill T-shirts & screen printing \$431.50

PEDEN'S INC Balefill - Disposal & Landfill Shirts & screen printing \$576.00

PEDEN'S INC - Total For Balefill - Disposal & Landfill \$1,007.50

PEDEN'S INC Police Administration Nameplate \$9.00

PEDEN'S INC - Total For Police Administration \$9.00

PEDEN'S INC - ALL DEPARTMENTS \$1,016.50

PEPSI COLA OF CASPER

PEPSI COLA OF CASPER Ice Arena - Concessions Beverage supplies \$45.21

PEPSI COLA OF CASPER Ice Arena - Concessions Beverages for concessions \$367.76

PEPSI COLA OF CASPER Ice Arena - Concessions C02 Cylinder Deposit (\$50.00)

PEPSI COLA OF CASPER Ice Arena - Concessions Beverages & supplies for concessions \$701.09

PEPSI COLA OF CASPER Ice Arena - Concessions Beverages for concessions \$545.67

PEPSI COLA OF CASPER Ice Arena - Concessions Beverages for concessions \$144.37

PEPSI COLA OF CASPER - Total For Ice Arena - Concessions \$1,754.10

PEPSI COLA OF CASPER - ALL DEPARTMENTS \$1,754.10

PETSMART #3082

PETSMART #3082 Metro Animal Shelter PET SHOPS-PET FOOD AND SUPPLY STORES \$54.11

PETSMART #3082 Metro Animal Shelter PET SHOPS-PET FOOD AND SUPPLY STORES \$60.91

PETSMART #3082 Metro Animal Shelter PET SHOPS-PET FOOD AND SUPPLY STORES \$70.33

PETSMART #3082 Metro Animal Shelter PET SHOPS-PET FOOD AND SUPPLY STORES \$33.99

PETSMART #3082 Metro Animal Shelter PET SHOPS-PET FOOD AND SUPPLY STORES \$109.73

PETSMART #3082 Metro Animal Shelter PET SHOPS-PET FOOD AND SUPPLY STORES \$32.99

PETSMART #3082 - Total For Metro Animal Shelter \$362.06

PETSMART #3082 - ALL DEPARTMENTS \$362.06

POSTAL PROS, INC.

POSTAL PROS, INC. Customer Service Electronic stmts, text msgs, E-payments, IVR \$2,327.90

POSTAL PROS, INC.	Customer Service	UB/Past Due Printing / Postage / Mail Servic	\$4,092.84
<i>POSTAL PROS, INC. - Total For Customer Service</i>			<i>\$6,420.74</i>
POSTAL PROS, INC.	Water Revenue and Transfers	Electronic stmts, text msgs, E-payments, IVR	\$646.50
<i>POSTAL PROS, INC. - Total For Water Revenue and Transfers</i>			<i>\$646.50</i>
POSTAL PROS, INC. - ALL DEPARTMENTS			\$7,067.24

POWERPHONE INC

POWERPHONE INC	Public Safety Communication	Annual software plan & training license	\$7,115.63
POWERPHONE INC	Public Safety Communication	Annual software plan & training license	\$5,656.85
<i>POWERPHONE INC - Total For Public Safety Communications</i>			<i>\$12,772.48</i>
POWERPHONE INC - ALL DEPARTMENTS			\$12,772.48

PRINTWORKS

PRINTWORKS	Regional Water Operations	Printing service - business cards	\$35.95
<i>PRINTWORKS - Total For Regional Water Operations</i>			<i>\$35.95</i>
PRINTWORKS - ALL DEPARTMENTS			\$35.95

PROFESSIONAL CLEANIN

PROFESSIONAL CLEANIN	WWTP Operations	Cleaning service	\$1,395.00
<i>PROFESSIONAL CLEANIN - Total For WWTP Operations</i>			<i>\$1,395.00</i>
PROFESSIONAL CLEANIN - ALL DEPARTMENTS			\$1,395.00

Publication Printers

Publication Printers	Rec Center - Operations	Activity Guide CRC PUBLISHING & PRINTING	\$31.45
<i>Publication Printers - Total For Rec Center - Operations</i>			<i>\$31.45</i>
Publication Printers - ALL DEPARTMENTS			\$31.45

PURVIS INDUSTRIES

PURVIS INDUSTRIES	WWTP Operations	GAS COMP 2 SLEEVE	\$75.03
<i>PURVIS INDUSTRIES - Total For WWTP Operations</i>			<i>\$75.03</i>
PURVIS INDUSTRIES - ALL DEPARTMENTS			\$75.03

RIDLEY'S 1132

RIDLEY'S 1132	Police Career Services	GROCERY STORES, SUPERMARKETS	\$7.18
<i>RIDLEY'S 1132 - Total For Police Career Services</i>			<i>\$7.18</i>
RIDLEY'S 1132 - ALL DEPARTMENTS			\$7.18

RILEY INDUSTRIAL SER

RILEY INDUSTRIAL SER	WWTP Operations	Aeration Basin Pipe Recoating	\$56,185.85
<i>RILEY INDUSTRIAL SER - Total For WWTP Operations</i>			<i>\$56,185.85</i>
RILEY INDUSTRIAL SER - ALL DEPARTMENTS			\$56,185.85

RMI CASPER

RMI CASPER	Balefill - Baler Processing	BALER SAW BLADES AND GLOVES	\$108.48
<i>RMI CASPER - Total For Balefill - Baler Processing</i>			<i>\$108.48</i>
RMI CASPER	Special Fire Assistance Fund	RERT2 - Comustible NDIR Sensor for Multirae	\$5,015.00
<i>RMI CASPER - Total For Special Fire Assistance Fund</i>			<i>\$5,015.00</i>
RMI CASPER - ALL DEPARTMENTS			\$5,123.48

ROADSAFE 3101

ROADSAFE 3101	Public Transit - Operations	BUSINESS SERVICES NOT ELSEWHERE CLASSI	\$1,306.92
<i>ROADSAFE 3101 - Total For Public Transit - Operations</i>			<i>\$1,306.92</i>
ROADSAFE 3101 - ALL DEPARTMENTS			\$1,306.92

Rocky Mountain

Rocky Mountain	Regional Water Operations	Bulk Oxygen - Chemicals	\$3,958.01
Rocky Mountain	Regional Water Operations	Bulk Oxygen - Chemicals	\$3,386.50
Rocky Mountain	Regional Water Operations	Bulk Oxygen - Chemicals	\$3,481.01
Rocky Mountain	Regional Water Operations	Bulk Oxygen - Chemicals	\$66.15
<i>Rocky Mountain - Total For Regional Water Operations</i>			<i>\$10,891.67</i>
Rocky Mountain	Water Distribution	Monthly rental	\$25.02
<i>Rocky Mountain - Total For Water Distribution</i>			<i>\$25.02</i>
Rocky Mountain - ALL DEPARTMENTS			\$10,916.69

ROCKY MOUNTAIN POWER

ROCKY MOUNTAIN POWER	Ash Street Building	Acct #54730761-154 1	\$550.49
<i>ROCKY MOUNTAIN POWER - Total For Ash Street Building</i>			\$550.49
ROCKY MOUNTAIN POWER	Balefill - Disposal & Landfill	Acct #54730761-090 7	\$10,204.72
ROCKY MOUNTAIN POWER	Balefill - Disposal & Landfill	Acct #54730761-139 2	\$218.19
<i>ROCKY MOUNTAIN POWER - Total For Balefill - Disposal & Landfill</i>			\$10,422.91
ROCKY MOUNTAIN POWER	Casper Business Center	Acct #54730761-159 0	\$12,614.19
<i>ROCKY MOUNTAIN POWER - Total For Casper Business Center</i>			\$12,614.19
ROCKY MOUNTAIN POWER	Fire-EMS Administration	Acct #54730761-141 8	\$532.69
ROCKY MOUNTAIN POWER	Fire-EMS Administration	Acct #54730761-141 8	\$555.64
<i>ROCKY MOUNTAIN POWER - Total For Fire-EMS Administration</i>			\$1,088.33
ROCKY MOUNTAIN POWER	Fleet Maintenance Fund	Acct #54730761-096 4	\$3,807.54
<i>ROCKY MOUNTAIN POWER - Total For Fleet Maintenance Fund</i>			\$3,807.54
ROCKY MOUNTAIN POWER	Parks - Special Areas	Acct #54730761-148 3	\$56.66
ROCKY MOUNTAIN POWER	Parks - Special Areas	Acct #54730761-132 7	\$2,164.39
<i>ROCKY MOUNTAIN POWER - Total For Parks - Special Areas</i>			\$2,221.05
ROCKY MOUNTAIN POWER	Public Transit - CARES Act	Acct #54730761-156 6	\$309.86
<i>ROCKY MOUNTAIN POWER - Total For Public Transit - CARES Act</i>			\$309.86
ROCKY MOUNTAIN POWER	Rec Center - Operations	Acct #54730761-095 6	\$4,896.80
<i>ROCKY MOUNTAIN POWER - Total For Rec Center - Operations</i>			\$4,896.80
ROCKY MOUNTAIN POWER	Regional Water Operations	Acct #60931133-009 4	\$81,318.83
<i>ROCKY MOUNTAIN POWER - Total For Regional Water Operations</i>			\$81,318.83
ROCKY MOUNTAIN POWER	RWS - Booster Stations	Acct #60931133-022 7	\$25.56
ROCKY MOUNTAIN POWER	RWS - Booster Stations	Acct #60931133-009 4	\$1,894.89
<i>ROCKY MOUNTAIN POWER - Total For RWS - Booster Stations</i>			\$1,920.45
ROCKY MOUNTAIN POWER	Water Tanks	Acct #54730761-107 9	\$34,498.85
ROCKY MOUNTAIN POWER	Water Tanks	Acct #54730761-002 2	\$2,524.60
<i>ROCKY MOUNTAIN POWER - Total For Water Tanks</i>			\$37,023.45
ROCKY MOUNTAIN POWER	WWTP Operations	Acct #54730761-004 8	\$181.15
ROCKY MOUNTAIN POWER	WWTP Operations	Acct #54730761-108 7	\$27,147.03
<i>ROCKY MOUNTAIN POWER - Total For WWTP Operations</i>			\$27,328.18
ROCKY MOUNTAIN POWER - ALL DEPARTMENTS			\$183,502.08

ROCKY MTN. FIRE SYST

ROCKY MTN. FIRE SYST	Ft. Caspar Museum	Annual inspection fire alarms	\$191.00
<i>ROCKY MTN. FIRE SYST - Total For Ft. Caspar Museum</i>			<i>\$191.00</i>
ROCKY MTN. FIRE SYST - ALL DEPARTMENTS			\$191.00

Router

Router	Golf - Operations	Portable restroom rental	\$560.00
<i>Router - Total For Golf - Operations</i>			<i>\$560.00</i>
Router	Parks - Parks Maint.	Porta-John from R&R	\$63.59
Router	Parks - Parks Maint.	Porta-John from R&R	\$88.10
Router	Parks - Parks Maint.	Porta-John from R&R	\$1,279.36
Router	Parks - Parks Maint.	Porta-John from R&R	\$208.80
Router	Parks - Parks Maint.	Porta-John from R&R	\$36.12
Router	Parks - Parks Maint.	Porta-John from R&R	\$136.83
Router	Parks - Parks Maint.	Porta-John from R&R	\$327.58
Router	Parks - Parks Maint.	Porta-John from R&R	\$200.42
Router	Parks - Parks Maint.	Porta-John from R&R	\$136.83
Router	Parks - Parks Maint.	Porta-John from R&R	\$136.83
Router	Parks - Parks Maint.	Porta-John from R&R	\$200.42
Router	Parks - Parks Maint.	Porta-John from R&R	\$63.59
Router	Parks - Parks Maint.	Porta-John from R&R	\$102.17
Router	Parks - Parks Maint.	Porta-John from R&R	\$433.24
<i>Router - Total For Parks - Parks Maint.</i>			<i>\$3,550.71</i>
Router - ALL DEPARTMENTS			\$4,110.71

ROSENBAUER MINNESOTA

ROSENBAUER MINNESOTA	Capital Projects Fund	Rosenbauer Cab and Chassis	\$314,187.00
ROSENBAUER MINNESOTA	Capital Projects Fund	Replacement Engines 2 & 6	\$326,296.00
ROSENBAUER MINNESOTA	Capital Projects Fund	Replacement Engines 2 & 6	\$326,296.00
<i>ROSENBAUER MINNESOTA - Total For Capital Projects Fund</i>			<i>\$966,779.00</i>
ROSENBAUER MINNESOTA - ALL DEPARTMENTS			\$966,779.00

ROTHHAMMER INTERNATI

ROTHHAMMER INTERNATI	Aquatics - Operations	Goggles	\$579.00
<i>ROTHHAMMER INTERNATI - Total For Aquatics - Operations</i>			<i>\$579.00</i>
ROTHHAMMER INTERNATI - ALL DEPARTMENTS			\$579.00

ROTO ROOTER

ROTO ROOTER	Buildings & Structures Fund	Contractor to clean sewer for Midget Footba	\$454.00
<i>ROTO ROOTER - Total For Buildings & Structures Fund</i>			<i>\$454.00</i>
ROTO ROOTER - ALL DEPARTMENTS			\$454.00

SAFARILAND LLC

SAFARILAND LLC	Police Administration	Uniform supplies / gear	\$4,990.80
<i>SAFARILAND LLC - Total For Police Administration</i>			<i>\$4,990.80</i>
SAFARILAND LLC - ALL DEPARTMENTS			\$4,990.80

SAMS CLUB #6425

SAMS CLUB #6425	Balefill - Disposal & Landfill	SAFETY MEETING SUPPLIES	\$25.00
SAMS CLUB #6425	Balefill - Disposal & Landfill	SEE ATTACHED FOR CREDIT INFORMATION	(\$177.00)
SAMS CLUB #6425	Balefill - Disposal & Landfill	MEMBERSHIP TO SAMS AND LDF ITEMS	\$140.00
SAMS CLUB #6425	Balefill - Disposal & Landfill	MEMBERSHIP TO SAMS AND LDF ITEMS	\$177.00
<i>SAMS CLUB #6425 - Total For Balefill - Disposal & Landfill</i>			<i>\$165.00</i>
SAMS CLUB #6425	Buildings & Structures Fund	Friday at the Rec Snacks & supplies; Custodia	\$52.96
SAMS CLUB #6425	Buildings & Structures Fund	Custodial Supplies - Ice Arena	\$237.68
<i>SAMS CLUB #6425 - Total For Buildings & Structures Fund</i>			<i>\$290.64</i>
SAMS CLUB #6425	Ice Arena - Concessions	Concession Resale Items	\$213.46
SAMS CLUB #6425	Ice Arena - Concessions	Concession - Resale Items	\$101.52
<i>SAMS CLUB #6425 - Total For Ice Arena - Concessions</i>			<i>\$314.98</i>
SAMS CLUB #6425	Rec Center - Classes	Friday at the Rec Snacks & supplies; Custodia	\$155.02
<i>SAMS CLUB #6425 - Total For Rec Center - Classes</i>			<i>\$155.02</i>
SAMS CLUB #6425	Refuse - Residential	SAFETY MEETING SUPPLIES	\$28.30
SAMS CLUB #6425	Refuse - Residential	MEMBERSHIP TO SAMS AND LDF ITEMS	\$177.00
SAMS CLUB #6425	Refuse - Residential	SEE ATTACHED FOR CREDIT INFORMATION	(\$177.00)
<i>SAMS CLUB #6425 - Total For Refuse - Residential</i>			<i>\$28.30</i>

SAMS CLUB #6425 - ALL DEPARTMENTS

\$953.94

SAMSCLUB #6425

SAMSCLUB #6425	Balefill - Disposal & Landfill	LYSOL, TRASH BAGS, SIMPLE T CLEANER	\$111.74
SAMSCLUB #6425	Balefill - Disposal & Landfill	COFFEE MAKER SPEC WASTE, CUSTOMER LO	\$171.77
<i>SAMSCLUB #6425 - Total For Balefill - Disposal & Landfill</i>			\$283.51
SAMSCLUB #6425	Ice Arena - Concessions	CONCESSIONS - Resale Items	\$133.95
<i>SAMSCLUB #6425 - Total For Ice Arena - Concessions</i>			\$133.95
SAMSCLUB #6425	Refuse - Residential	COFFEE MAKER SPEC WASTE, CUSTOMER LO	\$171.76
<i>SAMSCLUB #6425 - Total For Refuse - Residential</i>			\$171.76

SAMSCLUB #6425 - ALL DEPARTMENTS

\$589.22

SHELL OIL 1268913800

SHELL OIL 1268913800	Police Career Services	AUTOMATED FUEL DISPENSERS	\$18.00
<i>SHELL OIL 1268913800 - Total For Police Career Services</i>			\$18.00

SHELL OIL 1268913800 - ALL DEPARTMENTS

\$18.00

SHERWIN-WILLIAMS COR

SHERWIN-WILLIAMS COR	Buildings & Structures Fund	Rec Center repair supplies - Sherwin Williams	\$91.95
<i>SHERWIN-WILLIAMS COR - Total For Buildings & Structures Fund</i>			\$91.95

SHERWIN-WILLIAMS COR - ALL DEPARTMENTS

\$91.95

SHOSHONE DISTRIBUTIN

SHOSHONE DISTRIBUTIN	General Fund Revenue	Souvenirs for resale in museum store	\$1,759.50
<i>SHOSHONE DISTRIBUTIN - Total For General Fund Revenue</i>			\$1,759.50

SHOSHONE DISTRIBUTIN - ALL DEPARTMENTS

\$1,759.50

SIRCHIE ACQUISITION

SIRCHIE ACQUISITION	Police Investigations	COMMERCIAL EQUIPMENT, NOT ELSEWHER	\$219.95
<i>SIRCHIE ACQUISITION - Total For Police Investigations</i>			\$219.95

SIRCHIE ACQUISITION - ALL DEPARTMENTS

\$219.95

SMITH PSYCHOLOGICAL

SMITH PSYCHOLOGICAL	Police Administration	Confidential legal or medical matters	\$400.00
<i>SMITH PSYCHOLOGICAL - Total For Police Administration</i>			<i>\$400.00</i>
SMITH PSYCHOLOGICAL - ALL DEPARTMENTS			\$400.00

SOURCE OFFICE

SOURCE OFFICE	Cemetery	Labels for cemetery	\$596.24
<i>SOURCE OFFICE - Total For Cemetery</i>			<i>\$596.24</i>
SOURCE OFFICE - ALL DEPARTMENTS			\$596.24

SPORTSMANS WAREHOUSE

SPORTSMANS WAREHOUSE	Balefill - Diversion & Special	SCALE FOR WEIGHING MONTHLY INFECTIOU	\$46.99
<i>SPORTSMANS WAREHOUSE - Total For Balefill - Diversion & Special</i>			<i>\$46.99</i>
SPORTSMANS WAREHOUSE - ALL DEPARTMENTS			\$46.99

SQ MAKE ME A

SQ MAKE ME A	General Fund Revenue	Tshirts for resale in gift shop	\$331.00
<i>SQ MAKE ME A - Total For General Fund Revenue</i>			<i>\$331.00</i>
SQ MAKE ME A - ALL DEPARTMENTS			\$331.00

SQ PEDEN'S INC.

SQ PEDEN'S INC.	Buildings & Structures Fund	BAS Shop Supplies - Pedens	\$60.00
<i>SQ PEDEN'S INC. - Total For Buildings & Structures Fund</i>			<i>\$60.00</i>
SQ PEDEN'S INC.	Fire-EMS Training	Crew shirt with logo	\$600.00
<i>SQ PEDEN'S INC. - Total For Fire-EMS Training</i>			<i>\$600.00</i>
SQ PEDEN'S INC. - ALL DEPARTMENTS			\$660.00

SQ SUMMIT ELECTRIC

SQ SUMMIT ELECTRIC	Hogadon - Operations	Troubleshoot stair heat	\$450.00
<i>SQ SUMMIT ELECTRIC - Total For Hogadon - Operations</i>			<i>\$450.00</i>

SQ SUMMIT ELECTRIC - ALL DEPARTMENTS

\$450.00

STAPLES

STAPLES	Balefill - Diversion & Special	DESK FOR BALER	\$833.99
<i>STAPLES - Total For Balefill - Diversion & Special</i>			\$833.99
STAPLES	Buildings & Structures Fund	Repair supplies for Ice Arena - Staples	\$159.98
<i>STAPLES - Total For Buildings & Structures Fund</i>			\$159.98
STAPLES	Golf - Operations	SHop Supplies	\$90.53
<i>STAPLES - Total For Golf - Operations</i>			\$90.53
STAPLES	Parks - Parks Maint.	Office Supplies	\$105.93
<i>STAPLES - Total For Parks - Parks Maint.</i>			\$105.93
STAPLES	Police Federal Grants	STATIONARY, OFFICE AND SCHOOL SUPPLY S	\$35.97
<i>STAPLES - Total For Police Federal Grants</i>			\$35.97
STAPLES	Water Distribution	USB Receiver Technology Supplies	\$15.99
<i>STAPLES - Total For Water Distribution</i>			\$15.99
STAPLES - ALL DEPARTMENTS			\$1,242.39

STATE OF WY.

STATE OF WY.	City Clerk	Notary renewal application - Carla Mills Laats	\$60.00
<i>STATE OF WY. - Total For City Clerk</i>			\$60.00
STATE OF WY.	Health Insurance Fund	Retiree Subsidy - August 2022	\$17,136.80
<i>STATE OF WY. - Total For Health Insurance Fund</i>			\$17,136.80
STATE OF WY.	WWTP Operations	Loan #CW127	\$139,428.98
<i>STATE OF WY. - Total For WWTP Operations</i>			\$139,428.98
STATE OF WY. - ALL DEPARTMENTS			\$156,625.78

STATELINE NO 7 ARCHI

STATELINE NO 7 ARCHI	Capital Projects Fund	Washington Park Restroom Upgra	\$1,800.00
<i>STATELINE NO 7 ARCHI - Total For Capital Projects Fund</i>			\$1,800.00
STATELINE NO 7 ARCHI - ALL DEPARTMENTS			\$1,800.00

STEWART & STEVENSON

STEWART & STEVENSON	Refuse - Residential	Equipment repair	\$1,062.09
---------------------	----------------------	------------------	------------

STEWART & STEVENSON - Total For Refuse - Residential			\$1,062.09
--	--	--	------------

STEWART & STEVENSON - ALL DEPARTMENTS			\$1,062.09
--	--	--	-------------------

SUMMIT FIRE & SECURI

SUMMIT FIRE & SECURI	Balefill - Disposal & Landfill	Fire extinguishers & brackets	\$370.00
----------------------	--------------------------------	-------------------------------	----------

<i>SUMMIT FIRE & SECURI - Total For Balefill - Disposal & Landfill</i>			<i>\$370.00</i>
--	--	--	-----------------

SUMMIT FIRE & SECURI - ALL DEPARTMENTS			\$370.00
---	--	--	-----------------

SUN COUNTRY DISTRIBU

SUN COUNTRY DISTRIBU	Aquatics - Operations	Shipping for Chlorine Order	\$525.45
----------------------	-----------------------	-----------------------------	----------

<i>SUN COUNTRY DISTRIBU - Total For Aquatics - Operations</i>			<i>\$525.45</i>
---	--	--	-----------------

SUN COUNTRY DISTRIBU - ALL DEPARTMENTS			\$525.45
---	--	--	-----------------

SUPER 8 MOTEL

SUPER 8 MOTEL	Police Career Services	SUPER 8 MOTELS	\$496.48
---------------	------------------------	----------------	----------

SUPER 8 MOTEL	Police Career Services	SUPER 8 MOTELS	\$496.48
---------------	------------------------	----------------	----------

<i>SUPER 8 MOTEL - Total For Police Career Services</i>			<i>\$992.96</i>
---	--	--	-----------------

SUPER 8 MOTEL - ALL DEPARTMENTS			\$992.96
--	--	--	-----------------

SUTHERLANDS 2219

SUTHERLANDS 2219	Water Tanks	PVC Parts Mtn Rd ARV Booster & Lift Station	\$19.36
------------------	-------------	---	---------

<i>SUTHERLANDS 2219 - Total For Water Tanks</i>			<i>\$19.36</i>
---	--	--	----------------

SUTHERLANDS 2219 - ALL DEPARTMENTS			\$19.36
---	--	--	----------------

SYNERGY PAINTING LLC

SYNERGY PAINTING LLC	Balefill - Disposal & Landfill	New building or building modif	\$28,262.04
----------------------	--------------------------------	--------------------------------	-------------

<i>SYNERGY PAINTING LLC - Total For Balefill - Disposal & Landfill</i>			<i>\$28,262.04</i>
--	--	--	--------------------

SYNERGY PAINTING LLC - ALL DEPARTMENTS			\$28,262.04
---	--	--	--------------------

SYN-TECH SYSTEMS

SYN-TECH SYSTEMS	Fleet Maintenance Fund	FUELMASTER YEARLY MAINTENANCE AGREE	\$2,550.00
------------------	------------------------	-------------------------------------	------------

<i>SYN-TECH SYSTEMS - Total For Fleet Maintenance Fund</i>			\$2,550.00
--	--	--	------------

SYN-TECH SYSTEMS - ALL DEPARTMENTS			\$2,550.00
---	--	--	------------

TACO BELL 038931

TACO BELL 038931	Police Career Services	FAST FOOD RESTAURANTS	\$10.99
------------------	------------------------	-----------------------	---------

<i>TACO BELL 038931 - Total For Police Career Services</i>			\$10.99
--	--	--	---------

TACO BELL 038931 - ALL DEPARTMENTS			\$10.99
---	--	--	---------

TENNIS WAREHOUSE

TENNIS WAREHOUSE	Rec Center - Classes	tennis balls for tennis program	\$84.99
------------------	----------------------	---------------------------------	---------

<i>TENNIS WAREHOUSE - Total For Rec Center - Classes</i>			\$84.99
--	--	--	---------

TENNIS WAREHOUSE - ALL DEPARTMENTS			\$84.99
---	--	--	---------

THATCHER CO.

THATCHER CO.	WWTP Regional Interceptors	Ferrous chloride delivery on 9/12/22	\$17,534.97
--------------	----------------------------	--------------------------------------	-------------

<i>THATCHER CO. - Total For WWTP Regional Interceptors</i>			\$17,534.97
--	--	--	-------------

THATCHER CO. - ALL DEPARTMENTS			\$17,534.97
---------------------------------------	--	--	-------------

THE ANTLERWORKS

THE ANTLERWORKS	General Fund Revenue	Whistles for resale in museum store	\$259.00
-----------------	----------------------	-------------------------------------	----------

<i>THE ANTLERWORKS - Total For General Fund Revenue</i>			\$259.00
---	--	--	----------

THE ANTLERWORKS - ALL DEPARTMENTS			\$259.00
--	--	--	----------

THE HOME DEPOT

THE HOME DEPOT	Balefill - Disposal & Landfill	RIVER CLEAN UP WOVEN WIRE FENCE ROLLS	\$643.68
----------------	--------------------------------	---------------------------------------	----------

<i>THE HOME DEPOT - Total For Balefill - Disposal & Landfill</i>			\$643.68
--	--	--	----------

THE HOME DEPOT	Buildings & Structures Fund	Repair supplies for CBC and Transit Office - H	\$152.00
----------------	-----------------------------	--	----------

THE HOME DEPOT	Buildings & Structures Fund	Lighting repair supplies for Crossroads Pavilli	\$34.41
----------------	-----------------------------	---	---------

THE HOME DEPOT	Buildings & Structures Fund	Carpentry Supplies for Police Department - H	\$30.25
----------------	-----------------------------	--	---------

THE HOME DEPOT	Buildings & Structures Fund	Repair supplies for Rec Center - Home Depot	\$31.74
----------------	-----------------------------	---	---------

THE HOME DEPOT	Buildings & Structures Fund	Repair supplies for Ice Arena - Home Depot	\$43.96
----------------	-----------------------------	--	---------

THE HOME DEPOT	Buildings & Structures Fund	Ice Maker installation supplies for Fire 1 - Ho	\$120.32
----------------	-----------------------------	---	----------

THE HOME DEPOT	Buildings & Structures Fund	BAS Shop Supplies - Home Depot	\$155.89
<i>THE HOME DEPOT - Total For Buildings & Structures Fund</i>			<i>\$568.57</i>
THE HOME DEPOT	Metro Animal Shelter	HOME SUPPLY WAREHOUSE STORES	\$33.98
<i>THE HOME DEPOT - Total For Metro Animal Shelter</i>			<i>\$33.98</i>
THE HOME DEPOT	Parks - Special Areas	Perennials	\$279.64
THE HOME DEPOT	Parks - Special Areas	perennial refund	(\$131.25)
THE HOME DEPOT	Parks - Special Areas	perennials	\$125.00
THE HOME DEPOT	Parks - Special Areas	perennials	\$131.25
<i>THE HOME DEPOT - Total For Parks - Special Areas</i>			<i>\$404.64</i>
THE HOME DEPOT	Regional Water Operations	Dryer Vent Kit for Clothes Dryer - Machinery	\$16.98
<i>THE HOME DEPOT - Total For Regional Water Operations</i>			<i>\$16.98</i>
THE HOME DEPOT	Traffic Control	Penetrating oil for 12th & Wolcott pole swap	\$6.28
<i>THE HOME DEPOT - Total For Traffic Control</i>			<i>\$6.28</i>
THE HOME DEPOT - ALL DEPARTMENTS			\$1,674.13

THE UPS STORE

THE UPS STORE	Buildings & Structures Fund	Repair supplies for Transit Office - UPS Store	\$13.58
<i>THE UPS STORE - Total For Buildings & Structures Fund</i>			<i>\$13.58</i>
THE UPS STORE	WWTP Operations	AIR FLOW VALVES SHIPPED FOR REPAIR	\$37.08
<i>THE UPS STORE - Total For WWTP Operations</i>			<i>\$37.08</i>
THE UPS STORE - ALL DEPARTMENTS			\$50.66

TOP OFFICE PRODUCTS

TOP OFFICE PRODUCTS	Ft. Caspar Museum	Quarterly Maintenance agreement on copier	\$68.50
<i>TOP OFFICE PRODUCTS - Total For Ft. Caspar Museum</i>			<i>\$68.50</i>
TOP OFFICE PRODUCTS - ALL DEPARTMENTS			\$68.50

TOPZ LLC

TOPZ LLC	Police Career Services	EATING PLACES, RESTAURANTS	\$12.49
<i>TOPZ LLC - Total For Police Career Services</i>			<i>\$12.49</i>
TOPZ LLC - ALL DEPARTMENTS			\$12.49

TRETO CONST.

TRETO CONST.	Capital Projects Fund	Industrial Avenue Elm-David Co	\$69,673.00
<i>TRETO CONST. - Total For Capital Projects Fund</i>			<i>\$69,673.00</i>
TRETO CONST. - ALL DEPARTMENTS			\$69,673.00

TW ENTERPRISES INC

TW ENTERPRISES INC	WWTP Regional Interceptors	Toggle Switches	\$189.07
<i>TW ENTERPRISES INC - Total For WWTP Regional Interceptors</i>			<i>\$189.07</i>
TW ENTERPRISES INC - ALL DEPARTMENTS			\$189.07

TYLER TECHNOLOGIES I

TYLER TECHNOLOGIES I	Balefill - Disposal & Landfill	Time clocks annual maintenance-11/8/22 to	\$120.50
<i>TYLER TECHNOLOGIES I - Total For Balefill - Disposal & Landfill</i>			<i>\$120.50</i>
TYLER TECHNOLOGIES I	Refuse - Residential	Time clocks annual maintenance-11/8/22 to	\$120.50
<i>TYLER TECHNOLOGIES I - Total For Refuse - Residential</i>			<i>\$120.50</i>
TYLER TECHNOLOGIES I - ALL DEPARTMENTS			\$241.00

UBER TRIP

UBER TRIP	Police Career Services	TAXICABS/LIMOUSINES	\$30.75
UBER TRIP	Police Career Services	TAXICABS/LIMOUSINES	\$18.95
UBER TRIP	Police Career Services	TAXICABS/LIMOUSINES	\$38.38
<i>UBER TRIP - Total For Police Career Services</i>			<i>\$88.08</i>
UBER TRIP - ALL DEPARTMENTS			\$88.08

UBER TRIP

UBER TRIP	Police Career Services	TAXICABS/LIMOUSINES	\$5.00
<i>UBER TRIP - Total For Police Career Services</i>			<i>\$5.00</i>
UBER TRIP - ALL DEPARTMENTS			\$5.00

ULINE SHIP SUPPLIE

ULINE SHIP SUPPLIE	Aquatics - Operations	Paper Towels	\$46.50
<i>ULINE SHIP SUPPLIE - Total For Aquatics - Operations</i>			<i>\$46.50</i>

ULINE SHIP SUPPLIE - ALL DEPARTMENTS \$46.50

UNIFORMS 2 GEAR

UNIFORMS 2 GEAR	Police Career Services	Uniform supplies	\$160.96
UNIFORMS 2 GEAR	Police Career Services	Uniform supplies	\$16.00
UNIFORMS 2 GEAR	Police Career Services	Uniform supplies	\$1,609.28

UNIFORMS 2 GEAR - Total For Police Career Services \$1,786.24

UNIFORMS 2 GEAR - ALL DEPARTMENTS \$1,786.24

UNION WIRELESS

UNION WIRELESS	Water Tanks	Upper Rock Creek Reservoir SCADA & Cell Ph	\$95.32
----------------	-------------	--	---------

UNION WIRELESS - Total For Water Tanks \$95.32

UNION WIRELESS - ALL DEPARTMENTS \$95.32

UNITED 0162431542

UNITED 0162431542	Police Career Services	UNITED AIRLINES	\$574.10
-------------------	------------------------	-----------------	----------

UNITED 0162431542 - Total For Police Career Services \$574.10

UNITED 0162431542 - ALL DEPARTMENTS \$574.10

UNITED 0162431547

UNITED 0162431547	Police Career Services	UNITED AIRLINES	\$317.60
-------------------	------------------------	-----------------	----------

UNITED 0162431547 - Total For Police Career Services \$317.60

UNITED 0162431547 - ALL DEPARTMENTS \$317.60

UNITED 0162431549

UNITED 0162431549	Police Career Services	UNITED AIRLINES	\$474.10
-------------------	------------------------	-----------------	----------

UNITED 0162431549 - Total For Police Career Services \$474.10

UNITED 0162431549 - ALL DEPARTMENTS \$474.10

UNITED 0164200867

UNITED 0164200867	Police Career Services	UNITED AIRLINES	\$23.00
-------------------	------------------------	-----------------	---------

UNITED	0164200867	Police Career Services	UNITED AIRLINES	\$137.00
<i>UNITED 0164200867 - Total For Police Career Services</i>				<i>\$160.00</i>
UNITED 0164200867 - ALL DEPARTMENTS				\$160.00

UNITED 0164200874

UNITED	0164200874	Police Career Services	UNITED AIRLINES	\$45.00
UNITED	0164200874	Police Career Services	UNITED AIRLINES	\$66.00
<i>UNITED 0164200874 - Total For Police Career Services</i>				<i>\$111.00</i>
UNITED 0164200874 - ALL DEPARTMENTS				\$111.00

UNITED 0164200876

UNITED	0164200876	Police Career Services	UNITED AIRLINES	\$79.00
<i>UNITED 0164200876 - Total For Police Career Services</i>				<i>\$79.00</i>
UNITED 0164200876 - ALL DEPARTMENTS				\$79.00

UNITED 0164201583

UNITED	0164201583	Police Career Services	UNITED AIRLINES	\$35.00
<i>UNITED 0164201583 - Total For Police Career Services</i>				<i>\$35.00</i>
UNITED 0164201583 - ALL DEPARTMENTS				\$35.00

URGENT CARE OF CASPE

URGENT CARE OF CASPE	Property Insurance Fund	Catching Up Invoices for Drug Testing, FIT Te	\$3,064.00
URGENT CARE OF CASPE	Property Insurance Fund	Pre-Employment/Random/Post Accident Dru	\$2,384.00
<i>URGENT CARE OF CASPE - Total For Property Insurance Fund</i>			<i>\$5,448.00</i>
URGENT CARE OF CASPE - ALL DEPARTMENTS			\$5,448.00

USPS PO 5715580478

USPS PO 5715580478	Police Federal Grants	POSTAGE STAMPS	\$40.00
<i>USPS PO 5715580478 - Total For Police Federal Grants</i>			<i>\$40.00</i>
USPS PO 5715580478 - ALL DEPARTMENTS			\$40.00

USPS PO 5715580945

USPS PO 5715580945	Public Transit - Operations	POSTAGE INTERNATIONAL	\$19.65
<i>USPS PO 5715580945 - Total For Public Transit - Operations</i>			<i>\$19.65</i>
USPS PO 5715580945	Water Administration	POSTAGE - Certified Mail	\$11.75
<i>USPS PO 5715580945 - Total For Water Administration</i>			<i>\$11.75</i>
USPS PO 5715580945 - ALL DEPARTMENTS			\$31.40

VCN WYDOT CASPER CTR

VCN WYDOT CASPER CTR	Cemetery	Testing	\$87.76
<i>VCN WYDOT CASPER CTR - Total For Cemetery</i>			<i>\$87.76</i>
VCN WYDOT CASPER CTR	Parks - Special Areas	testing	\$87.76
<i>VCN WYDOT CASPER CTR - Total For Parks - Special Areas</i>			<i>\$87.76</i>
VCN WYDOT CASPER CTR - ALL DEPARTMENTS			\$175.52

VEOLIA WATER TECHNOL

VEOLIA WATER TECHNOL	WWTP Operations	Grit dewatering system components	\$3,789.03
VEOLIA WATER TECHNOL	WWTP Operations	Grit dewatering system components	\$3,789.03
<i>VEOLIA WATER TECHNOL - Total For WWTP Operations</i>			<i>\$7,578.06</i>
VEOLIA WATER TECHNOL - ALL DEPARTMENTS			\$7,578.06

VERIZON WIRELESS

VERIZON WIRELESS	Cemetery	Acct #442204089-00001	\$160.04
<i>VERIZON WIRELESS - Total For Cemetery</i>			<i>\$160.04</i>
VERIZON WIRELESS	Public Safety Communication	Acct #465552982-00003	\$78.49
VERIZON WIRELESS	Public Safety Communication	Acct #465552982-00010	\$80.16
<i>VERIZON WIRELESS - Total For Public Safety Communications</i>			<i>\$158.65</i>
VERIZON WIRELESS	Water Distribution	Acct #542255605-00001	\$276.59
<i>VERIZON WIRELESS - Total For Water Distribution</i>			<i>\$276.59</i>
VERIZON WIRELESS	WWTP Operations	Acct #842227834-00001	\$147.36
<i>VERIZON WIRELESS - Total For WWTP Operations</i>			<i>\$147.36</i>
VERIZON WIRELESS - ALL DEPARTMENTS			\$742.64

VOIANCE LLC

VOIANCE LLC	Public Safety Communication	BUSINESS SERVICES NOT ELSEWHERE CLASSI	\$661.45
<i>VOIANCE LLC - Total For Public Safety Communications</i>			<i>\$661.45</i>
VOIANCE LLC - ALL DEPARTMENTS			\$661.45

VRC COMPANIES LLC

VRC COMPANIES LLC	Human Resources	File destruction service	\$97.24
<i>VRC COMPANIES LLC - Total For Human Resources</i>			<i>\$97.24</i>
VRC COMPANIES LLC	Police Administration	File destruction fee	\$308.40
<i>VRC COMPANIES LLC - Total For Police Administration</i>			<i>\$308.40</i>
VRC COMPANIES LLC - ALL DEPARTMENTS			\$405.64

VZWRLSS MY VZ VB P

VZWRLSS MY VZ VB P	Golf - Operations	Cellular Service for irrigation Ipad	\$120.03
<i>VZWRLSS MY VZ VB P - Total For Golf - Operations</i>			<i>\$120.03</i>
VZWRLSS MY VZ VB P	Regional Water Operations	WTP Operator Cell Phone	\$51.78
<i>VZWRLSS MY VZ VB P - Total For Regional Water Operations</i>			<i>\$51.78</i>
VZWRLSS MY VZ VB P - ALL DEPARTMENTS			\$171.81

WAL-MART #1617

WAL-MART #1617	Police Administration	GROCERY STORES, SUPERMARKETS	\$5.23
<i>WAL-MART #1617 - Total For Police Administration</i>			<i>\$5.23</i>
WAL-MART #1617 - ALL DEPARTMENTS			\$5.23

WALMART.COM AA

WALMART.COM AA	Police Administration	DISCOUNT STORES	\$31.48
<i>WALMART.COM AA - Total For Police Administration</i>			<i>\$31.48</i>
WALMART.COM AA - ALL DEPARTMENTS			\$31.48

WAYNE COLEMAN CONSTR

WAYNE COLEMAN CONSTR	Capital Projects Fund	2nd & Lincoln Paving Improveme	\$545.60
----------------------	-----------------------	--------------------------------	----------

<i>WAYNE COLEMAN CONSTR - Total For Capital Projects Fund</i>			<i>\$545.60</i>
WAYNE COLEMAN CONSTR	Water Distribution	Construction project - not bui	\$7,104.58
<i>WAYNE COLEMAN CONSTR - Total For Water Distribution</i>			<i>\$7,104.58</i>
WAYNE COLEMAN CONSTR - ALL DEPARTMENTS			\$7,650.18

Wear Parts, Inc.

Wear Parts, Inc.	Balefill - Baler Processing	Tap taper & dies	\$69.43
<i>Wear Parts, Inc. - Total For Balefill - Baler Processing</i>			<i>\$69.43</i>
Wear Parts, Inc. - ALL DEPARTMENTS			\$69.43

WESTERN BUSINESS SOL

WESTERN BUSINESS SOL	Ft. Caspar Museum	Annual software license	\$495.00
<i>WESTERN BUSINESS SOL - Total For Ft. Caspar Museum</i>			<i>\$495.00</i>
WESTERN BUSINESS SOL - ALL DEPARTMENTS			\$495.00

WESTERN MEDICAL ASSO

WESTERN MEDICAL ASSO	Fire-EMS Training	Physicals	\$3,075.00
<i>WESTERN MEDICAL ASSO - Total For Fire-EMS Training</i>			<i>\$3,075.00</i>
WESTERN MEDICAL ASSO - ALL DEPARTMENTS			\$3,075.00

WESTERN SIGN & DESIG

WESTERN SIGN & DESIG	Police Administration	Installation of office door signs	\$155.70
WESTERN SIGN & DESIG	Police Administration	Installation of office door signs	\$131.41
<i>WESTERN SIGN & DESIG - Total For Police Administration</i>			<i>\$287.11</i>
WESTERN SIGN & DESIG - ALL DEPARTMENTS			\$287.11

WESTERN WATER CONSUL

WESTERN WATER CONSUL	Water Distribution	Poplar-CYtoCollins Design Wate	\$12,983.75
<i>WESTERN WATER CONSUL - Total For Water Distribution</i>			<i>\$12,983.75</i>
WESTERN WATER CONSUL - ALL DEPARTMENTS			\$12,983.75

WH LLC

WH LLC	Capital Projects Fund	Ford Wyoming Center South Walk	\$3,532.50
<i>WH LLC - Total For Capital Projects Fund</i>			<i>\$3,532.50</i>
WH LLC - ALL DEPARTMENTS			\$3,532.50

WITTEK GOLF

WITTEK GOLF	Golf - Operations	Range Balls	\$1,433.61
<i>WITTEK GOLF - Total For Golf - Operations</i>			<i>\$1,433.61</i>
WITTEK GOLF - ALL DEPARTMENTS			\$1,433.61

WM SUPERCENTER

WM SUPERCENTER	Balefill - Baler Processing	CORDLESS BATTERY CHARGERS	\$58.85
<i>WM SUPERCENTER - Total For Balefill - Baler Processing</i>			<i>\$58.85</i>
WM SUPERCENTER	Balefill - Disposal & Landfill	STAINLESS STEEL CLEANER	\$18.88
<i>WM SUPERCENTER - Total For Balefill - Disposal & Landfill</i>			<i>\$18.88</i>
WM SUPERCENTER	Regional Water Operations	Food for JPB Meeting, Sticky Notes, Paper PI	\$33.94
<i>WM SUPERCENTER - Total For Regional Water Operations</i>			<i>\$33.94</i>
WM SUPERCENTER - ALL DEPARTMENTS			\$111.67

WWWUSCONVERTERSCOM

WWWUSCONVERTERSCOM	Regional Water Operations	Converters & Adapters -Machinery Supplies	\$97.63
<i>WWWUSCONVERTERSCOM - Total For Regional Water Operations</i>			<i>\$97.63</i>
WWWUSCONVERTERSCOM - ALL DEPARTMENTS			\$97.63

WY CHILD SUPPORT CON

WY CHILD SUPPORT CON	Police Federal Grants	COURT COSTS INCLUDING ALIMONY AND CH	\$1.50
WY CHILD SUPPORT CON	Police Federal Grants	COURT COSTS INCLUDING ALIMONY AND CH	\$1.50
<i>WY CHILD SUPPORT CON - Total For Police Federal Grants</i>			<i>\$3.00</i>
WY CHILD SUPPORT CON - ALL DEPARTMENTS			\$3.00

WY. MACHINERY CO.

WY. MACHINERY CO.	Balefill - Disposal & Landfill	Auger bit & extension	\$806.25
<i>WY. MACHINERY CO. - Total For Balefill - Disposal & Landfill</i>			<i>\$806.25</i>
WY. MACHINERY CO.	Fleet Maintenance Fund	Equipment repair	\$610.10
WY. MACHINERY CO.	Fleet Maintenance Fund	Equipment repair	\$75.00
<i>WY. MACHINERY CO. - Total For Fleet Maintenance Fund</i>			<i>\$685.10</i>
WY. MACHINERY CO. - ALL DEPARTMENTS			\$1,491.35

WYOMING FIRST AID &

WYOMING FIRST AID &	Buildings & Structures Fund	First aid supplies	\$19.48
<i>WYOMING FIRST AID & - Total For Buildings & Structures Fund</i>			<i>\$19.48</i>
WYOMING FIRST AID & - ALL DEPARTMENTS			\$19.48

WYOMING STEEL & RECY

WYOMING STEEL & RECY	Balefill - Diversion & Special	Freon removal	\$1,750.00
<i>WYOMING STEEL & RECY - Total For Balefill - Diversion & Special</i>			<i>\$1,750.00</i>
WYOMING STEEL & RECY - ALL DEPARTMENTS			\$1,750.00

WYOMING WOOD 'N WORK

WYOMING WOOD 'N WORK	Hogadon - Operations	Wood for snow fence	\$4,999.75
<i>WYOMING WOOD 'N WORK - Total For Hogadon - Operations</i>			<i>\$4,999.75</i>
WYOMING WOOD 'N WORK - ALL DEPARTMENTS			\$4,999.75

XEROX CORPORATION

XEROX CORPORATION	Regional Water Operations	Copier usage	\$244.36
<i>XEROX CORPORATION - Total For Regional Water Operations</i>			<i>\$244.36</i>
XEROX CORPORATION - ALL DEPARTMENTS			\$244.36

YRC INC.

YRC INC.	WWTP Operations	FREIGHT CHARGE AB4 ACTUATOR	\$350.89
<i>YRC INC. - Total For WWTP Operations</i>			<i>\$350.89</i>
YRC INC. - ALL DEPARTMENTS			\$350.89

Zenni Optical

Zenni Optical	Balefill - Disposal & Landfill	BALER SAFETY GLASSES	\$104.85
<i>Zenni Optical - Total For Balefill - Disposal & Landfill</i>			<i>\$104.85</i>
Zenni Optical - ALL DEPARTMENTS			\$104.85

ZONAR SYSTEMS INC

ZONAR SYSTEMS INC	Balefill - Disposal & Landfill	GPS Kit/Samsung Tablet/Warranty 8/31/22 -	\$1,228.65
<i>ZONAR SYSTEMS INC - Total For Balefill - Disposal & Landfill</i>			<i>\$1,228.65</i>
ZONAR SYSTEMS INC - ALL DEPARTMENTS			\$1,228.65

CITYWIDE BILLS AND CLAIMS TOTAL **\$2,917,023.21**

I certify, under penalty of perjury, that this listing of vouchers and the items included therein for payment are correct and just in every respect.

SUBMITTED BY (Finance Dir) _____ DATE _____

DULY AUDITED BY (City Manager) _____ DATE _____

APPROVED BY (Mayor) _____ DATE _____

CITY of CASPER, WYOMING
 BILLS and CLAIMS ADDENDUM
 Council Meeting
 10/04/22

Additional Accounts Payable

09/15/22

Prewrits - Travel Reimbursements & Payroll Vendor

Jeremy Eastin - Travel reimbursement	430.25
Courtney Brakenrich - Travel reimbursement	265.50
Tyler Kauffman - Travel reimbursement	324.50
State of Wyo Dept of Admin & Info - State of Wyo sponsored insurance plans	855,952.53
	856,972.78

09/22/22

Prewrits - Payroll Vendors, Travel Reimbursements & Petty Cash

American Heritage Life Insurance Company (Allstate)	3,893.22
Continental American Insurance Company (Aflac)	583.20
Leonard Jacobs - Travel reimbursement	265.50
First Interstate Bank - Petty Cash (Municipal Court)	40.00
NCPERS Group Life Insurance	672.00
	5,453.92

Total Additional AP \$ 862,426.70

September 20, 2022

MEMO TO: J. Carter Napier, City Manager ^{SON}
FROM: Keith McPheeters, Police Chief ^{Yallop 307}
SUBJECT: Establishing a Public Hearing Regarding Proposed Changes to City of Casper Ordinances, Chapter 8.08, Private Intrusion Alarms

Meeting Type & Date

October 4, 2022, Regular Council Session

Action type

Minute Action

Recommendation

That, by minute action during the Regular Council Meeting of October 4, 2022, Council establish for public hearing the consideration of changes to the City of Casper Municipal Ordinances, Chapter 8.08, Private Intrusion Alarms.

Summary

On average, the Casper Police Department responds to approximately 1,200 private intrusion alarms a year. These calls for police response require a minimum of two officers, in addition to occupying the time and concentration of multiple dispatchers as well. Despite these public safety efforts and the necessary allocation of these resources, 99.2% of all private intrusion alarms are later determined to be “false.” Since 2017, the Patrol Division of the Casper Police Department has devoted an estimated 3,169 hours responding to false alarms.

Year to date, in our city, the police response to false alarms is up 45% over this same time last year.

Last year, the Casper Police Department responded to 133 Hold-up or Panic Alarms. These calls for police response require significantly more personnel and resources. In essence, virtually all other public safety operations immediately cease and all available personnel respond to the report of a Hold-up Alarm. Despite the serious nature of these calls for emergency police services, 91% of these calls for police service prove to have been made in error and zero were found to be for the stated purpose of a life-threatening emergency.

Responding to frequent and unnecessary alarms drains the resources of the Casper Police Department and denies or delays the achievement of other public safety goals. By changing our existing ordinance to address the occurrence and frequency of false alarms, a significant, positive impact on the efficiency of Patrol operations can be obtained. Without question, the failure to properly install, maintain, and educate the users of private intrusion and hold-up alarms contributes to this unacceptably high percentage of false alarms. These ordinance changes are meant to encourage the proper use and maintenance of alarms systems.

Currently, Chapter 8.08, Private Intrusion Alarms, regulates private intrusion alarms in our community. Existing portions of this chapter are inadequate, outdated, or are no longer enforceable. Despite their adverse impact to public safety operations, hold-up, robbery, duress, and panic alarms are not regulated at all by our existing ordinances. In addition, our ordinances do not comport with current public safety best practices and alarm industry standards.

The Casper Police Department convened a local “stakeholders” meeting, in which representatives of the local alarm service industry and local business owners (alarm users) were invited to attend and discuss the potential changes needed to mitigate the occurrence of false alarms and to update Chapter 8.08, Private Intrusion Alarms. The stakeholders reviewed current research regarding best practices to reduce false alarms. Among the reviewed materials were case history studies from cities facing similar issues: Phoenix, Reno, Sparks, Charlotte/Mecklenburg, Marietta, and Montgomery County, Maryland. Finally, the stakeholders reviewed the recommendations and best practices promulgated by the Security Industry Alarm Coalition (SIAC), and the International Association of Chiefs of Police (IACP).

The IACP and SIAC have endorsed a model ordinance, for municipalities, which encompasses the rapidly changing dynamics of the alarm industry as well as addressing the adverse impacts on public safety caused by false alarms.

It is the recommendation of the Casper Police Department that, rather than attempting edits to our existing ordinances in Chapter 8.08, we adopt and adapt the IACP model ordinance to the needs of our community.

Financial Considerations

None

Oversight/Project Responsibility

Keith McPheeters, Police Chief

Attachments

Draft Private Intrusion, Robbery, Hold-up, Duress, and Panic Alarms Ordinance.

ORDINANCE NO.

AN ORDINANCE REPEALING AND REPLACING
ORDINANCE NO. 16-97 CODIFIED AS CHAPTER 8.08 OF THE
CASPER MUNICIPAL CODE.

WHEREAS, the governing body of the City of Casper has the authority granted by Wyoming State Statute §15-1-103(a)(xiii) and (xli) to adopt ordinances and resolutions necessary to protect the health, safety and welfare of the City and of its citizens; and,

WHEREAS, the governing body of the City of Casper may perform all acts in relation to the concerns of the city necessary to the exercise of its corporate powers; and,

WHEREAS, the Casper Municipal Code needs updated and modified from time to time; and,

WHEREAS, this ordinance addresses the finding that excessive false alarms unduly burden the Casper Police Department's law enforcement resources; and,

WHEREAS, the purpose of this ordinance is to establish reasonable standards for users, to ensure that alarm owners are held responsible for the proper operation of their alarm systems; and,

WHEREAS, Public Safety agencies recognize the significant burdens placed on local law enforcement resources due to responding to false alarm calls; and,

WHEREAS, properly installed, monitored and operated alarm systems are effective tools which can identify criminal offenses in progress, and will lead to a reduction in the incidents of false alarms as well as enhance the safety of responding law enforcement officers; and,

WHEREAS, reduction of false alarms and clearly defined alarm user responsibilities are to the benefit of all parties.

NOW THEREFORE, BE IT ORDAINED BY THE GOVERNING BODY OF
THE CITY OF CASPER, WYOMING:

Section 1. Ordinance No. 16-97 as codified in the Casper Municipal Code as Chapter 8.08, Sections 8.08.010 through 8.08.170 is hereby repealed and replaced with this Ordinance and should be codified as set out in Section 2, below.

Section 2. This Ordinance is established to set reasonable standards for users, ensure that alarm owners are held responsible for their use of alarm systems, and to encourage the use of efficient security systems in accordance with established best practices and shall be codified as Chapter

8.08 of the Casper Municipal Code, titled “Private Intrusion, Robbery, Hold-up, Duress, and Panic Alarms Ordinance,” as follows:

8.08.010 Title

This Chapter shall be referred to as the “Private Intrusion, Robbery, Hold-up, Duress, and Panic Alarms Ordinance.”

8.08.020 Purpose

The purpose of this chapter is to set forth regulations governing private intrusion, robbery, hold-up, duress, and panic alarm systems within the City; to reduce the dangers and diversions of false alarms; to require registration of alarm systems and encourage alarm users to maintain their systems in good working order; to encourage alarm system users to use their systems properly; and to provide the authority to establish fees.

8.08.030 Definitions

The following words, terms, and phrases, when used in this ordinance, shall have the meanings ascribed to them, except where the context clearly indicates a different meaning:

- A. “Alarm Administrator” means a person or persons designated by the City to administer the provisions of this Ordinance.
- B. “Alarm Company” means a person, company, firm, or corporation, which has the contractual agreement with the alarm user and is subject to the licensing requirements promulgated by the City, and who is engaged in selling, leasing, installing, servicing or monitoring alarm systems; this entity shall be licensed in compliance with city, county and state laws.
- C. “Alarm Event” means an alarm system activation, to which law enforcement is requested to respond.
- D. “Alarm permit” means a permit issued to an alarm user by the City allowing the operation of an alarm system, which, as a function of its design and purpose, is the basis of a notification to the police that a police response is required or expected within the City.
- E. “Alarm system” means an assembly of equipment installed at a fixed location designed to detect and/or verify an occurrence of an illegal or unauthorized entry or other activity to which law enforcement is requested to respond.
- F. “Alarm user” means any person, corporation, partnership, proprietorship, governmental or educational entity or any other entity owning, leasing, or operating an alarm system, or

on whose premises an alarm system is maintained for the protection of such premises or the occupants therein.

- G. “Alarm User Awareness Class” means a class conducted for the purpose of educating alarm users about the responsible use, operation, maintenance of alarm systems and effective verification of alarms, and false alarm reduction strategies.
- H. “Cancellation” means that the alarm company provides notification that response by law enforcement is no longer being requested. If cancellation occurs prior to law enforcement’s arrival at the scene, this is not a false alarm for the purpose of civil penalty, and no penalty will be assessed.
- I. “Certified Alarm Technician” means a person holding a current and up-to-date designation or certification by the Electronic Security Association, or an equivalent certification from a national alarm industry organization or alarm equipment manufacturer.
- J. “City” means the City of Casper, or its agent.
- K. “Compliance Standards” means equipment and installation methods shall comply with all appropriate nationally recognized testing laboratories and American National Standards Institute (ANSI) requirements.
- L. “Do It Yourself/Monitor It Yourself (DIY/MIY) Systems” means all alarm systems installed, activated, utilized, or monitored by the user without the assistance of an Alarm Company or service. All such systems shall adhere to all requirements of this alarm ordinance, regardless of if the system is a “do it yourself” and/or “monitor it yourself.”
- M. “Dual-Activation Robbery/Hold-up Device” means a device which requires that two buttons be depressed together to activate an alarm signal for an in-progress robbery, hold-up, duress, or panic causing situation.
- N. “Enhanced Call Confirmation” means an attempt by the alarm system monitoring company to contact the alarm site and/or alarm user, to determine whether an alarm event is valid before requesting law enforcement response. A second attempt will be made to contact the alarm user if the first attempt fails. EXCEPT:
 - 1. as defined by ANSI/CSAA CS V 01 2016 or current version, in case of a fire, panic, robbery-in-progress alarm or verified alarm.
- O. “False alarm” means the activation of an alarm system when, upon observation by Law Enforcement, there is no evidence of unauthorized entry, robbery, or other such crime attempted in or on the premises. False alarm does not include alarms activated by violent conditions of nature, such as blizzards, tornadoes, earthquakes, or any other similar causes beyond the control of the user of an alarm system. False alarms generated by incorrect system installation or by inappropriate or overly-sensitive alarm system settings, which are

triggered by reasonably anticipated, or regionally common weather-related events or other similar minor acts of nature, shall not be exempt from designation as a false alarm.

- P. "Local alarm" means an alarm system that is not monitored by a remote monitoring center.
- Q. "Permit year means" a 12-month, calendar year period, beginning on the day and month on which an alarm permit is issued and ending on December 31st of the year in which the permit was issued.
- R. "Robbery", hold-up, duress, or panic alarm" means any alarm system or alarm function which is designed to report an incident involving the immediate and currently occurring jeopardy of human life due to criminal acts of violent crime such as those associated with armed robbery, hold-ups, kidnapping, and similar acts of criminal violence.
- S. "Runaway alarm" means an alarm system that produces repeated alarm activations that do not appear to be caused by separate human action. Law Enforcement may, in its discretion, discontinue police responses to alarm activations from what appears to be a runaway alarm.

8.08.040 Alarm Registration, Permitting, and Permit Fees

- A. **Permit required.** No person shall use an alarm system without first obtaining a permit, from the City, for that alarm system. A fee may be required for the initial registration and annual renewals. Each alarm permit shall be assigned a unique permit number, and the user shall provide the permit number to the alarm company to facilitate law enforcement dispatch. Permits are issued for a calendar year and are subject to renewal prior to the commencement of any subsequent calendar year.
- B. **Application.** The permit shall be requested on an application form provided by the City. An alarm user has the duty to obtain an application from the City. The Application shall include the full name, address, and phone number of at least three (3) responsible persons authorized to exercise control over the operations of the intended alarm system and the required response, upon request of responding law enforcement personnel, to alarm activations. For new residential alarm permit applicants who are new to the City, and, who may not yet know or have the required three (3) responsible persons authorized to exercise control over the alarm, it is permissible to submit application for the initial calendar year permit with less than three (3) responsible persons.
- C. **Transfer of possession.** When the possession of the premises at which an alarm system is maintained or operated is transferred, the person (user) obtaining possession of the property shall file an application for an alarm permit within 30 (thirty) days of obtaining possession of the property. Alarm permits are not transferable.
- D. **Annual Renewal of Alarm Permit.** No later than January 1st of each year, renewing alarm permit holders shall provide an alarm permit renewal application to the City along with the associated permit renewal fee. The annual alarm permit renewal shall provide verification

that the list of responsible persons authorized to exercise control over the operations of the alarm system is accurate and up-to-date.

- E. **Reporting updated information.** Whenever the required information provided on the alarm permit application changes, including the contact information for the three responsible persons authorized to exercise control over the alarm, the alarm user shall provide corrected information to the City within 30 (thirty) days of the change. In addition, at the beginning of each calendar year after the issuance of the permit, permit holders will receive from the City a form requesting updated information. The permit holder shall complete and return this form to the City whether or not any of the requested information has changed. Failure to provide updated information and verification of information upon annual renewal will constitute a violation of this ordinance and shall result in a civil penalty. The inability to contact responsible persons authorized to exercise control over the alarm system due to outdated, invalid, or incorrect contact information, as provided and maintained by the alarm user with the permit application, update, or renewal, shall constitute *prima facie* evidence of a violation of this Ordinance.
- F. **Multiple alarm systems.** If an alarm user has one (1) or more alarm systems protecting two (2) or more separate structures having different addresses and/or tenants, a separate permit shall be required for each structure and/or tenant.
- G. **Alarm system installers.** The name of the service provider that installed the system, or if installed by the alarm user DIY (“do it yourself”), shall be indicated on the permit application by the applicant.
- H. **Monitoring Agency.** The name of the monitoring station that is monitoring the alarm system, or, if it is to be monitored by the alarm user MIY (“monitor it yourself”), shall be indicated on the permit application by the applicant.
- I. **Permit Fees.** The commercial and residential properties alarm permit fee is Twenty-Five Dollars (\$25.00), per permit, per calendar year. A new permit for the sole purpose of notification to the City of changes to an alarm system or its responsible persons contact information will not require a renewal fee for that year.
- J. **Annual Renewal Permit.** Police response to a property without a valid annual renewal will be subject to the same fee as failing to register.
- K. **Alarm Company Permit.** All Alarm Companies shall obtain an Alarm Company Permit from the City, the fee for which will be One-Hundred Dollars (\$100.00), per calendar year. Renewal of Alarm Company Permits shall occur no later than January 1 of the new calendar year and are valid for the duration of the calendar year. The Alarm Company Permit application and renewal shall contain current contact information for the persons responsible for the Alarm Company as well as a current list of all certified alarm technicians performing work for them.

8.080.50 Duties of the Alarm User

- A. Maintain the premises and the alarm system in a method that will reduce or eliminate false alarms.
- B. Provide the alarm company the permit number, (the number must be provided to the communications center by the alarm company to facilitate dispatch).
- C. Respond or cause a representative to respond to the alarm system's location within a reasonable amount of time, not to exceed twenty (20) minutes, upon notification and request by the Casper Police Department.
- D. Not manually activate an alarm for any reason other than an occurrence of an event that the alarm system was intended to report.
- E. An alarm user must obtain a new permit and pay any associated fees if there is a change in address or ownership of the location of the alarm-system.
- F. An alarm user must keep current the annual renewal of the alarm permit as well as provide, within thirty (30) days of any change, any update for any required contact information for the three responsible persons for the alarm system.
- G. An alarm user that installs the alarm system themselves (Do It Yourself, or DIY) or who will be monitoring the alarm system themselves (Monitor It Yourself, or MIY) is subject to the same duties as described in paragraph (A), (D), (E), (F), (H), and (I) of 8.08.060.

8.08.060 Duties of the Alarm Company

- A. Any alarm system installed within the City after the effective date of this ordinance shall be equipped with an uninterrupted power supply in such a manner that failure of or interruption of normal electric service will not activate the alarm. The uninterruptable, back-up power supply shall be capable of providing, at a minimum, at least four (4) hours of operation.
- B. Every person performing alarm installation or alarm servicing for a permitted Alarm Company shall be a certified alarm technician or be in training to become a certified alarm technician. Any person in training to become a certified alarm technician shall have his or her work and final product supervised, inspected, and approved by a certified alarm technician working for the same Alarm Company.
- C. Any person engaged in the alarm business in the city shall comply with the following:
 - 1. Obtain and maintain any required state, county and/or city license(s).
 - 2. Provide name, address, and telephone numbers of the alarm company license holder or a designee who can be called in an emergency, twenty-four (24) hours

a day; and be able to respond to an alarm call, when notified, within a reasonable amount of time.

3. Be able to provide the most current contact information for the alarm user; and to contact a key holder for a response, if requested.
- D. No alarm company, or any employee of an alarm company, or self-monitoring alarm system user shall make a false statement to the alarm administrator.
 - E. No alarm salesperson, alarm service person, or alarm installer shall activate an alarm signal that results in a false alarm reported to the police.
 - F. Prior to activation of the alarm system, the alarm company must provide instructions explaining the proper operation of the alarm system to the alarm user(s).
 - G. Provide information of how to obtain service from the alarm company for the alarm system.
 - H. Upon enactment of this ordinance, alarm installation companies shall, on all new and upgraded installations, install or provide only devices which require dual-activation of a two-button alarm activation function on any device(s) to be used for the purpose of reporting a robbery, hold-up, duress, or panic situation for any application in any commercial or residential account.
 - I. An alarm company responsible for monitoring services shall:
 1. Ensure the monitoring center utilizes Enhanced Call Confirmation. The monitoring center shall make two (2) attempts to contact user or users of alarm system prior to requesting law enforcement response.
 2. Provide alarm user registration number to the communications center to facilitate dispatch and/or cancellations.
 3. Communicate any available information regarding specifics of the alarm event.
 4. Communicate a cancellation to the law enforcement communications center as soon as possible following a determination that a police response is unnecessary.

8.08.070 Duties of the Law Enforcement upon Response to an Alarm Activation

- A. Upon arrival at the site of an alarm activation of an alarm system, responding law enforcement officers shall make reasonable effort to determine if the alarm activation was a result of criminal activity, attempted criminal activity, or other emergency situation.
- B. Upon the reasonable determination that an alarm activation meets the definition of a false alarm, a responding officer shall leave written notification of the false alarm response at the site of the alarm activation, as is reasonably possible given the conditions and circumstances present at the alarm activation site.

- C. Upon the issuance of a notification of a false alarm response, a copy of the notification shall be mailed to the alarm user listed on the alarm permit application.

8.08.080 Prohibited Acts

- A. It shall be unlawful to activate an alarm system for the purpose of summoning law enforcement when no private intrusion, burglary, robbery, or other crime dangerous to life or property is being committed, or attempting to be committed, or to otherwise cause a false alarm.
- B. It shall be unlawful to install, maintain, or use an external, audible alarm system which can sound continually for more than 10 minutes.

8.08.090 Excessive False Private Alarms; Fees and Suspensions Therefor

- A. **Excessive false private intrusion alarms; fees.** It is hereby found and determined that three (3) or more false private intrusion alarms within a permit year is excessive and shall be unlawful.
 - 1. Civil fees and constraints around police response for false private intrusion alarms within a permit year shall be assessed against an alarm user as follows:

Third false alarm	\$ 75.00
Fourth false alarm	\$150.00
Fifth false alarm	\$250.00
Sixth and subsequent false alarm	\$500.00

- B. **Excessive false robbery, hold-up, duress, or panic alarms; fees.** It is hereby found and determined that the nature and intent of robbery, hold-up, duress, or panic alarms is to summon emergency personnel to the scene of the alarm for an apparent immediate jeopardy to human life, and that, as such, it is common that such alarms create a significant commitment of emergency personnel and resources. Further, it is hereby found and determined that excessive false robbery, hold-up, duress, and panic alarms create additional drain on public safety resources and should therefore be treated with the gravity such unwarranted resource allocations adversely cause to public safety. Therefore, it is hereby found and determined that two or more, false robbery, hold-up, duress, or panic alarms within a permit year is excessive and shall be unlawful.
 - 1. Civil fees and constraints around police response for false robbery, hold-up, duress, or panic alarms within a permit year may be assessed against an alarm user as follows:

Second false alarm	\$250.00
Third false alarm	\$500.00
Fourth and subsequent false alarm	\$750.00

- C. Suspension of law enforcement response – Excessive false alarms.** After an alarm site has accumulated eight (8) false alarm responses in a twelve (12) month alarm permit period, the Alarm Administrator shall notify the alarm user, the alarm installation company, or monitoring company, in writing, at least thirty (30) calendar days before police response to an alarm system's notifications is to be discontinued. Suspension of alarm response does not apply to duress, robbery, holdup, and panic alarms. The notice of suspension must also include the amount of the penalty amount for each false alarm, and a description of the appeals procedure available to the alarm user and the alarm installation company or monitoring company.
- D. Reinstatement of suspended sites for excessive false alarms.** A person whose alarm permit has been suspended may obtain reinstatement of the permit by the Alarm Administrator if the person submits to the Alarm Administrator:
1. A \$25.00 reinstatement fee.
 2. Sufficient demonstration and articulation, in writing, addressing proactive measures which have been implemented to prevent false alarms in the future.
 3. Certification from an alarm installation company stating that the alarm has been inspected and/or repaired for any case where repetitive, obvious malfunctioning of the system or the system's settings has occurred.
- E. Reinstatement of response.** The Police Department shall reinstate its response to an alarm site as soon as practical, after receiving notice of reinstatement from the Alarm Administrator. Reinstatement of police response to an alarm pursuant to these procedures does not constitute a new permit for the purpose of calculating the fees associated with police responses to a false alarm during the calendar permit year. Subsequent responses to false alarms shall be assessed fees in accordance with the total number of previous false alarms during the calendar permit year.
- F. Additional suspension of service.** If an alarm permit is reinstated after suspension, the Police Department may again discontinue service if it is determined that two (2) false alarms have occurred within sixty (60) days after the reinstatement date. Notification of any such additional discontinuation of service shall be delivered to the alarm user, the alarm installation company, or monitoring company, in writing, at least thirty (30) calendar days before police response to an alarm system's notifications is to be discontinued. Suspension of alarm response does not apply to duress, robbery, holdup, and panic alarms.
- G. Alarm Administrator discretion.** In the Alarm Administrator's sole discretion, the Alarm Administrator may waive required alarm inspection certification or alarm user training prior to approving reinstatement, and may reduce or waive false alarm fees, as appropriate. The Alarm Administrator's decision to approve or deny reinstatement, or to reduce or waive fees, shall be made to further the efficient use of Police Department resources and in the interests of the public health, safety and welfare.

8.08.100 Civil Fees and Penalties for Administrative Violations

- A. Violations of any portion of this Chapter's administrative requirements are subject to the following civil penalties and fees:
1. Failure to Register for an Alarm Permit \$100.00
 2. Failure to Renew an Operating or Active Alarm Permit \$100.00
 3. Failure to Update Contact Information for Responsible Alarm Users within 30 Days of any Change or at Permit Renewal \$100.00
- B. Other Civil Penalties. Violations will be enforced through the assessment of civil penalties in the amount of One Hundred Dollars (\$100.00) per violation.
- C. Payment of Civil Penalties. Civil penalties shall be paid within (30) days from the date of the invoice.
1. Discontinuance of law enforcement response. The failure of an alarm user to make payment of any civil penalties assessed under this ordinance, within 60 days from the date of the invoice, may result in discontinuance of law enforcement response to alarm signals that may occur at the premises described in the alarm user's permit, until payment is received. This provision does not apply to any alarm sites for panic/duress alarm activations or robbery/hold up alarms even though the site is suspended.
- D. Civil Non-criminal violation.
A violation of any of the provisions of this Ordinance shall be a civil violation and shall not constitute a criminal, misdemeanor infraction.

8.08.120 Alarm User Awareness Class.

- A. The City may establish an Alarm User Awareness Class and may request the assistance of the area alarm companies to assist in developing and conducting the class. The class shall inform alarm users of the problems created by false alarms and instruct alarm users how to help reduce false alarms. The City may grant the option of attending an educational class in lieu of paying one assessed fine, not to exceed One Hundred Dollars (\$100.00). As part of this class, information pertaining to security systems that may also provide a verified alarm to the police shall be provided.
- B. Alternatively, the class can be delivered to the user as an online training module.
- C. Upon submission to the Alarm Administrator proof of a successful attendance and completion of such a class, the Alarm Administrator shall waive any penalty or fee, not to exceed One Hundred Dollars (\$100.00).

8.08.130 Appeals Process.

- A. Assessments of civil penalties and other enforcement decisions made under this ordinance may be appealed by filing a written notice of appeal with the Casper Police Department within thirty (30) days after the date of notification of the assessment of civil penalties or other enforcement decision. The failure to give written notice of appeal within this time period shall constitute a waiver of the right to contest the assessment of a penalty, or penalties, or other enforcement decision. Appeals shall be heard using the contested case format of the Wyoming Administrative Procedures Act. The hearing officer's decision is subject to review in the district court by proceedings in the nature of certiorari.
- B. The hearing officer shall review an appeal from the assessment of civil penalties or other enforcement decisions using a preponderance of the evidence standard. Notwithstanding a determination that the preponderance of the evidence supports the assessment of civil penalties or other enforcement decision, the hearing officer shall have the discretion to dismiss or reduce civil penalties or reverse any other enforcement decision, where warranted.

8.08.140 Confidentiality

In the interest of public safety, all information contained in and gathered through the alarm registration applications, no response records, applications for appeals and any other alarm records shall be held in confidence by all employees and/or representatives of the City.

8.08.160 Government Immunity

Alarm registration is not intended to, nor will it, create a contract, duty or obligation, either expressed or implied, of response to any alarm, nor for the timeliness thereof. Any, and all, liability and consequential damage resulting from the failure to respond to a notification is hereby disclaimed and governmental immunity as provided by law is retained. By applying for an alarm registration, the alarm user acknowledges that the Casper Police Department's response may be influenced or negated by factors such as the availability of police units, priority of calls, weather conditions, traffic conditions, emergency conditions, staffing levels, and prior response history.

8.08 180 Severability

The provisions of this ordinance are severable. If a court determines that a word, phrase, clause, sentence, paragraph, subsection, section, or other provision is invalid or that the application of any part of the provision to any person or circumstance is invalid, the remaining provisions and the application of those provisions to other persons or circumstances are not affected by that decision.

This Ordinance shall become in full force and effect twenty-one (21) days after passage on third reading and publication.

PASSED on 1st reading the ____ day of _____, 2022

PASSED on 2nd reading the ____ day of _____, 2022

PASSED, APPROVED, AND ADOPTED on third and final reading the ____ day of _____, 2022.

APPROVED AS TO FORM:

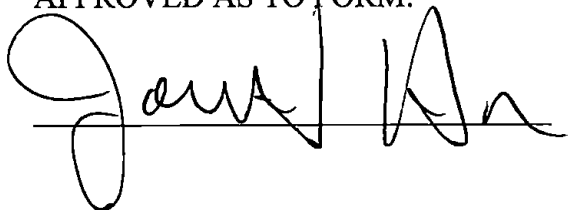
A handwritten signature in black ink, appearing to read "Fleur Tremel", written over a horizontal line.

ATTEST:

CITY OF CASPER, WYOMING
A Municipal Corporation

Fleur Tremel
City Clerk

Ray Pacheco
Mayor

MEMO TO: J. Carter Napier, City Manager *JCN*

FROM: Fleur Tremel, Assistant to the City Manager/City Clerk *FT*
Carla Mills-Laatsch, Licensing Specialist *CMY*

SUBJECT: Public Hearing Date for a New Restaurant Liquor License No. 48 for Blues Gypsy, LLC, d/b/a the Bluebird at the Cheese Barrel, Located at 544 South Center.

Meeting Type & Date
Regular Council Meeting
October 4, 2022

Action type
Public Hearing
Minute Action

Recommendation
That Council, by minute action, consider the application for a new restaurant liquor license No. 48 for Blues Gypsy, LLC, d/b/a The Bluebird at the Cheese Barrel, located at 544 South Center.

Summary
An application has been received requesting a new restaurant liquor license No. 48 for Blues Gypsy, LLC, d/b/a The Bluebird at the Cheese Barrel, located at 544 South Center.

In 2021, the Wyoming Liquor Laws regarding restaurants were amended. Restaurant liquor licenses now must have a dispensing area rather than a dispensing room. City Council will now approve a dispensing “area”, and the area will be age restricted to individuals 18 and over. No consumption can take place in this area.

The main requirement now is that meals must be prepared and served for on premises consumption. Previously, the service of “only fry orders” or sandwiches and hamburgers did not qualify an establishment as a restaurant. Blues Gypsy, LLC plans to serve breakfast and brunch items, beer, wine, Bloody Marys and mimosas. If approved, this license will be active immediately.

As required by Municipal Code 05.08.070, a notice was published in a local newspaper once a week for two consecutive weeks. As required by State Statute 12-4-104(a) it is being advertised on the City’s website (www.casperwy.gov).

Financial Considerations
The City of Casper will receive the prorated license fee, totaling \$726 in revenue.

Oversight/Project Responsibility
Carla Mills-Laatsch, Licensing Specialist

Attachments
Copy of Application
Affidavit of Website Publication

NEW OR TRANSFER LIQUOR LICENSE OR PERMIT APPLICATION

FOR LIQUOR DIVISION USE ONLY		
Customer #:	_____	
Trf from:	_____	
Reviewer:	Initials	Date
Agent:		/ /
Chief:		/ /

To be completed by City/County Clerk

Local License #: Restaurant 48

License Fees: Annual Fee: \$ _____ Date filed with clerk: 9/12/2022

Prorated Fee: \$ 726.00 Advertising Dates: (2 Weeks) 9/21/2022 & 9/25/2022

Transfer Fee: \$ _____ Hearing Date: 10/14/2022

Publishing Fee: \$ _____

Publishing Fee Direct Billed to Applicant:

License Term: 10/15/2022 Through 03/31/2023
Month Day Year Month Day Year

LICENSING AUTHORITY: Begin publishing promptly. As W.S. 12-4-104(d) specifies: NO LICENSING AUTHORITY SHALL APPROVE OR DENY THE APPLICATION UNTIL THE LIQUOR DIVISION HAS CERTIFIED THE APPLICATION IS COMPLETE!

Applicant: Jacquie Anderson Blues Gypsy LLC

Trade/Business Name (dba): The Bluebird at the Cheese Barrel

Building to be licensed/Building Address: 544 S. Center
Number & Street

Casper WV 82601 NATRONA
City State Zip County

Local Mailing Address: 1201 Nottingham Dr
Number & Street or P.O. Box

CASPER WV 82609
City State Zip

Local Business Telephone Number: 308 235-5202 Fax Number: ()

Business E-Mail Address: bluebirdofCasper@gmail.com

FILING FOR	FILING IN (CHOOSE ONLY ONE)	FILING AS (CHOOSE ONLY ONE)
<input checked="" type="checkbox"/> NEW LICENSE	<input checked="" type="checkbox"/> CITY OF: <u>Casper</u>	<input type="checkbox"/> INDIVIDUAL
<input type="checkbox"/> TRANSFER OF LOCATION	<input type="checkbox"/> COUNTY OF: <u>NATRONA</u>	<input type="checkbox"/> PARTNERSHIP
<input type="checkbox"/> TRANSFER OWNERSHIP	<input type="checkbox"/> ASSIGNMENT LETTER ATTACHED	<input type="checkbox"/> LP/LLP
FORMERLY HELD BY: _____		<input checked="" type="checkbox"/> LLC
		<input type="checkbox"/> CORPORATION
		<input type="checkbox"/> LTD PARTNERSHIP
		<input type="checkbox"/> ORGANIZATION
		<input type="checkbox"/> OTHER _____

TYPE OF LICENSE OR PERMIT (CHOOSE ONLY ONE)

RETAIL LIQUOR LICENSE	<input checked="" type="checkbox"/> RESTAURANT LIQUOR LICENSE	<input type="checkbox"/> MICROBREWERY
<input type="checkbox"/> ON-PREMISE ONLY (BAR)	<input type="checkbox"/> RESORT LIQUOR LICENSE	<input type="checkbox"/> WINERY
<input type="checkbox"/> OFF-PREMISE ONLY (PACKAGE STORE)	<input type="checkbox"/> BAR AND GRILL	<input type="checkbox"/> DISTILLERY SATELLITE
<input type="checkbox"/> COMBINATION ON/OFF PREMISE (BOTH BAR & PACKAGE STORE)	LIMITED RETAIL (CLUB)	<input type="checkbox"/> WINERY SATELLITE
	<input type="checkbox"/> VETERANS CLUB	<input type="checkbox"/> COUNTY RETAIL/SPECIAL MALT BEVERAGE PERMIT
	<input type="checkbox"/> FRATERNAL CLUB	
	<input type="checkbox"/> GOLF CLUB	
	<input type="checkbox"/> SOCIAL CLUB	

SPECIAL DESIGNATIONS

CONVENTION FACILITY GOLF CLUB RESORT

CIVIC CENTER/EVENT CENTER/ PUBLIC AUDITORIUM GUEST RANCH

To Assist the Liquor Division with scheduling inspections: **OPERATIONAL STATUS**

FULL TIME (e.g. Jan through Dec) (specify months of operation) from JAN to De

SEASONAL/PART-TIME DAYS OF WEEK (e.g. Mon through Sat) from Mon to Sun

NON-OPERATIONAL/PARKED HOURS OF OPERATION (e.g. 10a - 2a) from 6a to 2p

ALL APPLICANTS MUST COMPLETE QUESTIONS 1-4

1. **BUILDING OWNERSHIP:** Does the applicant? W.S. 12-4-103(a)(iii)

- (a) **OWN** the licensed building? *In Process of purchasing* YES (own)
- (b) **LEASE** the licensed building? (Lease must be through the term of the liquor license) YES (lease)

If Yes, please submit a copy of the lease and indicate:

- (i) When the lease expires, located on page 1 paragraph 2 of lease.
- (ii) Where the **Sales** provision for alcoholic or malt beverages is located, on page Amendment paragraph _____ of lease.
(**MUST** contain a provision for **SALE OF ALCOHOLIC or MALT BEVERAGES.**)

2. To operate your liquor business, have you assigned, leased, transferred or contracted with any other person (entity) to operate and assert total or partial control of the license and the licensed building? W.S. 12-4-601(b)

YES NO

3. Does any manufacturer, brewer, rectifier, wholesaler, or through a subsidiary affiliate, officer, director or member of any such firm: W.S. 12-5-401, 12-5-402, 12-5-403

- (a) Hold any interest in the license applied for? YES NO
- (b) Furnish by way of loan or any other money or financial assistance for purposes hereof in your business? YES NO
- (c) Furnish, give, rent or loan any equipment, fixtures, interior decorations or signs other than standard brewery or manufacturer's signs? YES NO
- (d) If you answered **YES** to any of the above, explain fully and submit any documents in connection there within:

4. Does the **applicant** have any interest or intent to acquire an interest in any other liquor license issued by **this** licensing authority? W.S. 12-4-103(b)

YES NO

If "YES", explain: _____

5. **BAR AND GRILL LICENSE OR RESTAURANT LICENSE:**

Have you submitted a valid food service permit or application? W.S. 12-4-413(a)

YES NO

6. **RESORT LICENSE:**

Does the resort complex:

- (a) Have an actual valuation of at least one million dollars, or have you committed or expended at least one million dollars (\$1,000,000.00) on the complex, excluding the value of the land? W.S. 12-4-401(b)(i) YES NO
- (b) Include a restaurant and a convention facility which will seat at least one hundred (100) persons? W.S. 12-4-401(b)(ii) YES NO
- (c) Include motel, hotel or privately owned condominium, town house or home accommodations approved for short term occupancy with at least one hundred (100) sleeping rooms? W.S. 12-4-401(b)(iii) YES NO
- (d) If no on question (c), have a ski resort facility open to the general public in which you have committed or expended not less than 10 million dollars (\$10,000,000.00)? W.S. 12-4-401(b)(iv) YES NO
- (e) Are you contracting/leasing the food and beverage services? W.S. 12-4-403(b)
 - 1. If Yes, have you submitted a copy of the food and beverage contract/lease? YES NO

7. **MICROBREWERY LICENSE:**

Will the license be held in conjunction with another liquor license? W.S. 12-4-412(b)(iii)

YES NO

- (a) If "YES", please specify type: RETAIL RESTAURANT RESORT
 BAR AND GRILL WINERY

(b) Do you self distribute your products? W.S. 12-2-201(a) YES NO
(Requires wholesale malt beverage license with the Liquor Division)

8. **WINERY LICENSE:**

Will the license be held in conjunction with another liquor license? W.S. 12-4-412(b)(iii)

YES NO

- (a) If "YES", please specify type: RETAIL RESTAURANT RESORT
 BAR AND GRILL MICROBREWERY

2

Need

9. LIMITED RETAIL (CLUB) LICENSE:

FRATERNAL CLUBS W.S. 12-1-101(a)(iii)(B)

- (a) Has the fraternal organization been actively operating in at least thirty-six (36) states?
(b) Has the fraternal organization been actively in existence for at least twenty (20) years?

10. LIMITED RETAIL (CLUB) LICENSE:

VETERANS CLUBS W.S. 12-1-101(a)(iii)(A):

- (a) Does the Veteran's organization hold a charter by the Congress of the United States?
(b) Is the membership of the Veteran's organization comprised only of Veterans and its duly organized auxiliary?

11. LIMITED RETAIL (CLUB) LICENSE:

GOLF CLUBS W.S. 12-1-101(a)(iii)(D)/W.S. 12-4-301(e):

- (a) Do you have more than fifty (50) bona fide members?
(b) Do you own, maintain, or operate a bona fide golf course together with clubhouse?
(c) Are you a political subdivision of the state that owns, maintains, or operates a golf course?
1. Are you contracting/leasing the food and beverage services?
2. If Yes, have you submitted a copy of the food and beverage contract/lease?

12. LIMITED RETAIL (CLUB) LICENSE:

SOCIAL CLUBS W.S. 12-1-101(a)(iii)(E)/W.S. 12-4-301(b):

- (a) Do you have more than one hundred (100) bona fide members who are residents of the county in which the club is located?
(b) Is the club incorporated and operating solely as a nonprofit organization under the laws of this state?
(c) Is the club qualified as a tax exempt organization under the Internal Revenue Service?
(d) Has the club been in continuous operation for a period of not less than one (1) year?
(e) Has the club received twenty-five dollars (\$25.00) from each bona fide member as Recorded by the secretary of the club and are club members at the time of this application in good standing by having paid at least one (1) full year in dues?
(f) Does the club hold quarterly meetings and have an actively engaged membership carrying out the objectives of the club?
(g) Have you filed a true copy of your bylaws with this application?
(h) Has at least fifty one percent (51%) of the membership signed a petition indicating a desire to secure a Limited Retail Liquor License? (Petition Attached)

13. If applicant is filing as an Individual, Partnership or Club: W.S. 12-4-102(a)(ii) & (iii)

Each individual, partner or club officer must complete the box below.

Table with 7 columns: True and Correct Name, Date of Birth, Residence Address No. & Street City, State & Zip, Residence Phone Number, Have you been a DOMICILED resident for at least 1 year and not claimed residence in any other state in the last year?, Have you been Convicted of a Felony Violation?, Have you been Convicted of a Violation Relating to Alcoholic Liquor or Malt Beverages? The table contains 6 rows of empty boxes for data entry.

(If more information is required, list on a separate piece of paper and attach to this application.)

14. If the applicant is a Corporation, Limited Liability Company, Limited Liability Partnership or Limited Partnership: W.S. 12-4-102(a)(iv) & (v)

Each stockholder holding, either jointly or severally, ten percent (10%) or more of the outstanding and issued capital stock of the corporation, limited liability company, limited liability partnership, or limited partnership, and every officer, and every director must complete the box below.

Table with 8 columns: True and Correct Name, Date of Birth, Residence Address No. & Street City, State & Zip, Residence Phone Number, No. of Years in Corp or LLC, % of Corporate Stock Held, Have you been Convicted of a Felony Violation?, Have you been Convicted of a Violation Relating to Alcoholic Liquor or Malt Beverages? Handwritten entry: Jaqueline R Anderson.

(If more information is required, list on a separate piece of paper and attach to this application)

REQUIRED ATTACHMENTS:

- Checkboxes for: A statement indicating the financial condition and financial stability of the applicant W.S. 12-4-102(a)(vi); Attach any lease agreements (especially for resort/political subdivisions leasing out food & beverage services) W.S. 12-4-103 (a)(iii)/W.S. 12-4-403(b)/W.S. 12-4-301(e); If transferring a license from one ownership to another, a form of assignment from the current licensee to the new applicant authorizing the transfer W.S. 12-4-601(b).

OATH OR VERIFICATION

(Requires signatures by ALL individuals, ALL Partners, ONE (1) LLC Member, or TWO (2) Corporate Officers or Directors except that if all the stock of the corporation is owned by ONE (1) individual then that individual may sign and verify the application upon his oath, or TWO (2) Club Officers.) W.S. 12-4-102(b)

Under penalty of perjury, and the possible revocation or cancellation of the license, I swear the above stated facts, are true and accurate.

STATE OF WYOMING)
COUNTY OF Natrona) SS.

Signed and sworn to before me on this 12th day of September, 2020 that the facts alleged in the foregoing instrument are true by the following:

- 1) Signature line with handwritten signature and printed name 'Jacque Anderson' and title 'owner'.
2) Signature line
3) Signature line
4) Signature line
5) Signature line
6) Signature line

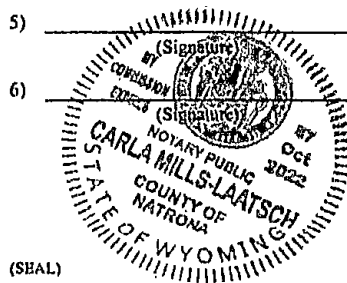

Witness my hand and official seal: [Signature] Signature of Notary Public

My commission expires: 10/2022

AFFIDAVIT OF WEBSITE PUBLICATION

State of Wyoming)
County of Natrona)

I, the undersigned, being in the employ of the City of Casper and responsible for the publishing and posting of notices for the Casper City Council's public hearings concerning liquor licensing, and knowing the facts herein set forth do solemnly swear that:

- Notice of the public hearing set forth below was posted continually on the City of Casper website in accordance with W.S. 12-4-104. The said posting commenced on 09/21/2022 and ended on 10/05/2022 and
- Attached is image of the Notice as actually posted on the City of Casper website (www.casperwy.gov) for the entire period referenced above.

By: Carla Mills Laaton Date: 9/19/2022

Title: Licensing Specialist

Scribed in my presence and sworn before me on this

19 day of September, 2022

Courtney B. Williams

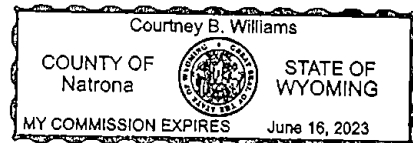

Provide to City of Casper Central Records

NEW RESTAURANT LIQUOR LICENSE

An application for a new Restaurant Liquor License No. 48 Blues Gypsy, LLC dba The Bluebird at the Cheese Barrel, located at 544 South Center Street has been received in this office. Public Hearing on said application will be held on October 4, 2022, at 6:00 p.m. in the City Council Chambers at 200 North David, Casper, Wyoming.

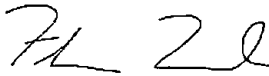

Fleur Tremel
City Clerk

Publish: September 21 & 25, 2022

ORDINANCE NO. 15-22

AN ORDINANCE APPROVING A PARTIAL PLAT VACATION, REPLAT, VACATION OF PUBLIC PARKLAND AND ZONE CHANGE FOR THE NORTH PLATTE RIVER PARK NO. 2 SUBDIVISION IN THE CITY OF CASPER, WYOMING.

WHEREAS, an application has been made to vacate and replat a portion of Tract 4, North Platte River Park Subdivision to create North Platte River Park No. 2, comprising 185-acres, more or less, and located generally northwest of the Events Center, and including the Events Center parcel; and,

WHEREAS, Lots 1 and 2, North Platte River Park No. 2 are proposed to be vacated from public use for park purposes, pursuant to W.S. §15-1-103(a)(xii); and,

WHEREAS, pursuant to W.S. §15-7-303, notice of the hearing for consideration of the vacation of park property from public use has been published for three (3) consecutive weeks prior to the public hearing in the Casper Star Tribune; and,

WHEREAS an application has been made to rezone proposed Lots 1 and 2, North Platte River Park No. 2 from PH (Park Historic) to M-1 (Limited Industrial) and M-2 (General Industrial) respectively; and,

WHEREAS, the requested partial plat vacation, replat, vacation of public parkland and rezoning requires approval by ordinance, following a public hearing; and,

WHEREAS, after a public hearing on November 18, 2021, the City of Casper Planning and Zoning Commission passed a motion recommending that City Council approve the proposal; and,

WHEREAS, the governing body of the City of Casper finds that the above described partial vacation of plat, replat, vacation of public parkland, and zone change, should be approved.

NOW, THEREFORE, BE IT ORDAINED BY THE GOVERNING BODY OF THE CITY OF CASPER, WYOMING:

SECTION 1:

The partial plat vacation and replat creating the North Platte River Park No. 2 Addition is hereby approved.

SECTION 2:

The vacation of proposed Lots 1 and 2, North Platte River Park No. 2 Addition from public use as park property is found to be in the public interest; notice of the public hearing has been published for three (3) consecutive weeks; the City has owned the property for more than ten (10) years, and no substantial use has been made thereof for park purposes. Therefore, said lots are hereby vacated from public use as park property.

SECTION 3:

The zoning of North Platte River Park No. 2 Addition shall be as follows:

- Lot 1 - M-2 (General Industrial);
- Lot 2 – M-1 (Limited Industrial);
- Lot 3 – (will remain zoned as PH (Park Historic))

SECTION 4:

This ordinance shall be in full force and effect from and after passage on three readings and publication pursuant to law.

PASSED on 1st reading the 20th day of Sept., 2022.

PASSED on 2nd reading the ____ day of _____, 202 .

PASSED, APPROVED, AND ADOPTED on 3rd and final reading the ____ day of _____, 20 .

APPROVED AS TO FORM:

Walter Trout

ATTEST:

CITY OF CASPER, WYOMING
A Municipal Corporation

Fleur Tremel
City Clerk

Ray Pacheco
Mayor

Proposed North Platte River Park No. 2 Subdivision

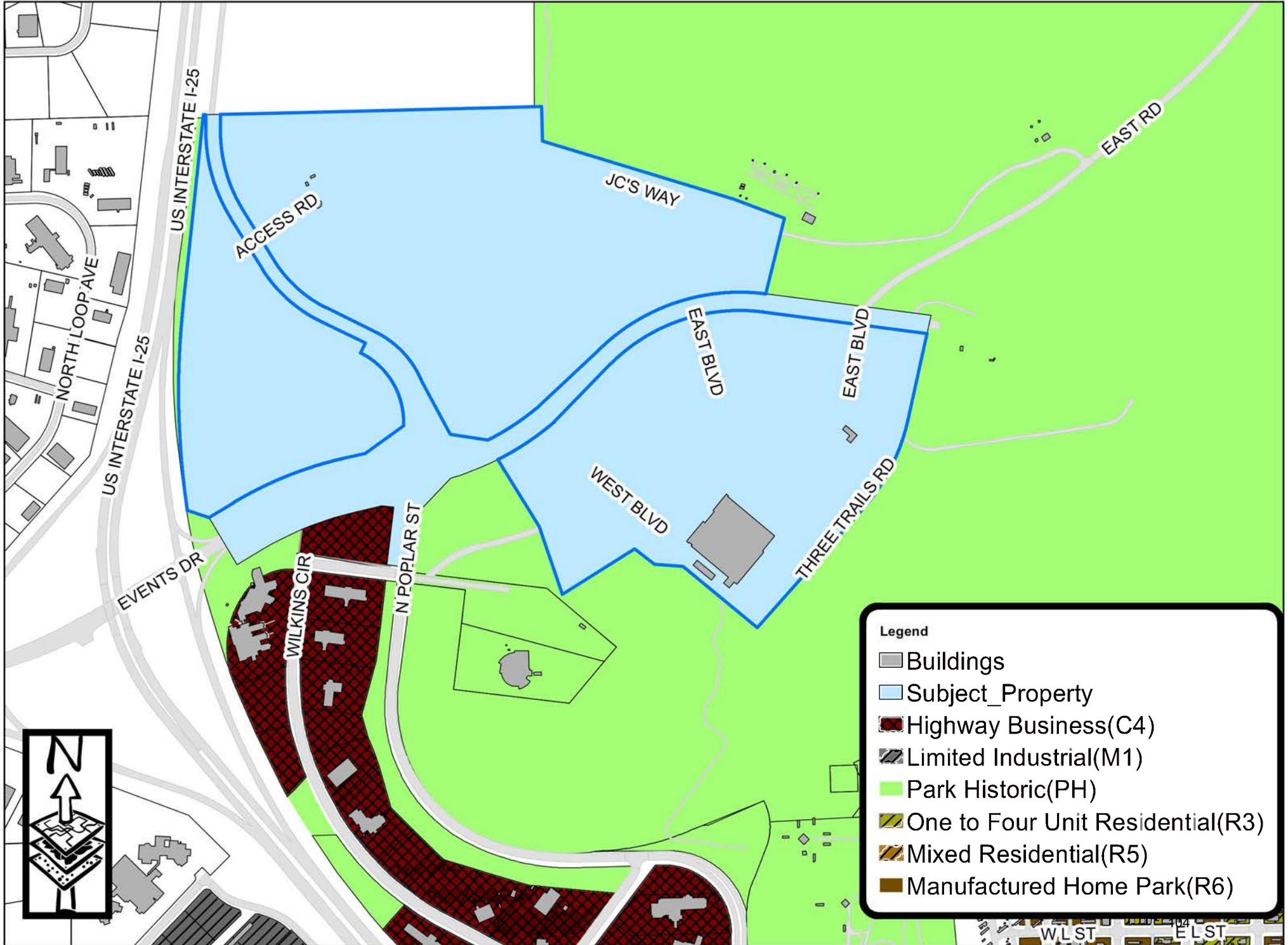

Proposed North Platte River Park No. 2 Subdivision



CERTIFICATE OF DEDICATION

STATE OF WYOMING }
COUNTY OF NATRONA }SS

THE UNDERSIGNED, STEVEN K. FREEL, AS MAYOR OF THE CITY OF CASPER, DOES HEREBY CERTIFY THAT THEY ARE THE OWNERS AND PROPRIETORS OF THE FOLLOWING DESCRIBED PARCEL OF LAND BEING A PORTION OF TRACT 4, NORTH PLATTE RIVER PARK, RECORDED AS INSTRUMENT NO. 266227, ON JUNE 28, 1979 AND SITUATE IN THE S½E½ AND THE N½E½ OF SECTION 32, AND THE S½W½ AND THE N½W½ OF SECTION 33, T.34N., R.79W., 6TH P.M., NATRONA COUNTY, WYOMING, BEING MORE PARTICULARLY DESCRIBED AS FOLLOWS:

COMMENCING AT THE NE¼ CORNER COMMON TO SAID SECTIONS 32 AND 33, MONUMENTED BY A BRASS CAP AND BEING THE POINT OF BEGINNING;

THENCE S01°19'42"E, ALONG THE LINE COMMON TO SECTIONS 32 AND 33, A DISTANCE OF 189.28 FEET TO A POINT, MONUMENTED BY A BRASS CAP;

THENCE S73°03'04"E, A DISTANCE OF 1094.11 FEET TO A POINT, MONUMENTED BY A BRASS CAP;

THENCE S69°36'44"E, A DISTANCE OF 295.39 FEET TO A POINT, MONUMENTED BY A BRASS CAP;

THENCE S13°48'45"W, A DISTANCE OF 426.44 FEET TO A POINT, MONUMENTED BY A BRASS CAP;

THENCE S82°31'45"E, A DISTANCE OF 912.59 FEET TO A POINT, MONUMENTED BY A BRASS CAP;

THENCE S12°33'35"W, A DISTANCE OF 586.51 FEET TO A POINT OF CURVATURE, MONUMENTED BY A BRASS CAP;

THENCE ALONG A CURVE TO THE RIGHT HAVING RADIUS OF 1100.00 FEET, THROUGH A CENTRAL ANGLE OF 29°07'47", DISTANCE OF 559.25 FEET, WITH A CHORD BEARING OF S27°07'29"W, A DISTANCE OF 553.25 FEET TO THE END OF CURVE, MONUMENTED BY A BRASS CAP;

THENCE S41°14'22"W, A DISTANCE OF 860.78 FEET TO A POINT, MONUMENTED BY A BRASS CAP;

THENCE N50°26'08"W, A DISTANCE OF 526.11 FEET TO A POINT, MONUMENTED BY A BRASS CAP;

THENCE N86°01'42"W, A DISTANCE OF 155.67 FEET TO A POINT, MONUMENTED BY A BRASS CAP;

THENCE N52°18'33"W, A DISTANCE OF 139.05 FEET TO A POINT, MONUMENTED BY A BRASS CAP;

THENCE S57°45'09"W, A DISTANCE OF 467.87 FEET TO A POINT, MONUMENTED BY A BRASS CAP;

THENCE N18°40'19"W, A DISTANCE OF 391.65 FEET TO A POINT, MONUMENTED BY A BRASS CAP;

THENCE N31°50'34"W, A DISTANCE OF 432.22 FEET TO A POINT, MONUMENTED BY A BRASS CAP;

THENCE IN A SOUTHEAST DIRECTION ALONG A CURVE TO THE RIGHT HAVING A RADIUS OF 1560.00 FEET, THROUGH A CENTRAL ANGLE OF 10°10'38", A DISTANCE OF 277.10 FEET, WITH A CHORD BEARING OF S68°17'17"W, A DISTANCE OF 276.73 FEET TO THE END OF CURVE, MONUMENTED BY A BRASS CAP;

THENCE S43°36'44"W, A DISTANCE OF 249.65 FEET TO AN ANGLE POINT, MONUMENTED BY A BRASS CAP;

THENCE S06°47'42"W, A DISTANCE OF 311.14 FEET TO THE NORTHEAST CORNER OF THE NORTH PLATTE INDUSTRIAL PARK, MONUMENTED BY A BRASS CAP;

THENCE N83°14'27"W, A DISTANCE OF 139.88 FEET TO A POINT LOCATED ON THE NORTH LINE OF WILKINS WAY AND BEING THE SOUTHEAST CORNER OF AN UNPLATTED PARCEL RECORDED AS INSTRUMENT NO. 990378, MONUMENTED BY A WYDOT MONUMENT;

THENCE N06°39'54"E, ALONG THE EAST LINE OF SAID UNPLATTED PARCEL, A DISTANCE OF 318.78 FEET, TO THE NORTHEAST CORNER OF SAID UNPLATTED PARCEL, MONUMENTED BY A WYDOT MONUMENT;

THENCE N84°43'38"W, ALONG THE NORTH LINE OF SAID UNPLATTED PARCEL, A DISTANCE OF 65.84 FEET TO AN ANGLE POINT, MONUMENTED BY A WYDOT MONUMENT;

THENCE S76°41'51"W, ALONG THE NORTH LINE OF SAID UNPLATTED PARCEL, A DISTANCE OF 153.98 FEET TO A POINT OF CURVATURE, MONUMENTED BY A WYDOT MONUMENT;

THENCE ALONG A CURVE TO THE LEFT HAVING A RADIUS OF 1759.86 FEET, THROUGH A CENTRAL ANGLE OF 17°52'59", A DISTANCE OF 549.29 FEET, WITH A CHORD BEARING OF S67°58'56"W, A DISTANCE OF 547.06 FEET TO THE END OF CURVE, MONUMENTED BY A WYDOT MONUMENT;

THENCE S59°00'29"W, A DISTANCE OF 156.92 FEET TO A POINT, MONUMENTED BY A WYDOT MONUMENT;

THENCE N31°00'11"W, A DISTANCE OF 300.73 FEET TO A POINT, MONUMENTED BY A WYDOT MONUMENT;

THENCE N71°19'59"W, A DISTANCE OF 124.17 FEET TO A POINT, LOCATED ON THE EAST LINE OF INTERSTATE 25, MONUMENTED BY A WYDOT MONUMENT;

THENCE IN A NORTHWEST DIRECTION ALONG THE EAST LINE OF INTERSTATE 25, AND A CURVE TO THE RIGHT HAVING A RADIUS OF 4433.66 FEET, THROUGH A CENTRAL ANGLE OF 14°30'20", A DISTANCE OF 1122.47 FEET, WITH A CHORD BEARING OF N01°10'09"W, A DISTANCE OF 1119.47 FEET TO THE END OF CURVE, MONUMENTED BY A WYDOT MONUMENT;

THENCE N06°04'30"E, ALONG THE EAST LINE OF INTERSTATE 25, A DISTANCE OF 414.13 FEET, TO AN ANGLE POINT, MONUMENTED BY A WYDOT MONUMENT;

THENCE N06°03'39"E, ALONG THE EAST LINE OF INTERSTATE 25, A DISTANCE OF 636.32 FEET TO THE NORTHWEST CORNER OF THE PARCEL BEING DESCRIBED, LOCATED ON THE NORTH LINE OF THE S½W½ OF SAID SECTION 32, MONUMENTED BY A WYDOT MONUMENT;

THENCE N88°34'12"E, ALONG THE NORTH LINE OF THE S½W½ OF SAID SECTION 32, A DISTANCE OF 125.98 FEET TO AN ANGLE POINT, MONUMENTED BY A WYDOT MONUMENT

THENCE N88°37'16"E, ALONG THE NORTH LINE OF THE S½W½ OF SAID SECTION 32, A DISTANCE OF 402.29 FEET TO THE NE¼ CORNER OF SAID SECTION 32, MONUMENTED BY A BRASS CAP;

THENCE N88°33'47"E, ALONG THE NORTH LINE OF THE S½W½ OF SAID SECTION 32, A DISTANCE OF 1323.55 FEET TO THE POINT OF BEGINNING.

THE ABOVE DESCRIBED TRACT OF LAND CONTAINS 185.10 ACRES, MORE OR LESS AND IS SUBJECT TO ANY RIGHTS-OF-WAY AND/OR EASEMENTS, RESERVATIONS AND ENCUMBRANCES WHICH HAVE BEEN LEGALLY ACQUIRED.

THE TRACT OF LAND, AS IT APPEARS ON THIS PLAT, IS DEDICATED WITH THE FREE CONSENT AND IN ACCORDANCE WITH THE DESIRES OF THE UNDERSIGNED OWNER AND PROPRIETOR. THE NAME OF THE SUBDIVISION SHALL BE "NORTH PLATTE RIVER PARK NO. 2" AND THE OWNER HEREBY GRANTS TO THE PUBLIC AND PRIVATE UTILITY COMPANIES AN EASEMENT AND LICENSE TO LOCATE, CONSTRUCT, USE AND MAINTAIN CONDUITS, LINES, WIRES AND PIPES, ANY OR ALL OF THEM, UNDER AND ALONG THE STRIPS OF LAND MARKED "UTILITY EASEMENT" AS SHOWN ON THIS PLAT. ALL ROADS AND STREETS AS SHOWN HEREON ARE HEREBY DEDICATED TO THE USE OF THE PUBLIC.

A VACATION AND REPLAT OF
A PORTION OF TRACT 4
NORTH PLATTE RIVER PARK SUBDIVISION
AS
NORTH PLATTE RIVER PARK NO. 2

AN ADDITION TO THE CITY OF CASPER, WYOMING
BEING A PORTION OF THE S½E½ AND THE N½E½ OF
SECTION 32, AND THE S½W½ AND THE N½W½ OF
SECTION 33, T.34N., R.79W., 6TH P.M.
NATRONA COUNTY, WYOMING
OCTOBER, 2021

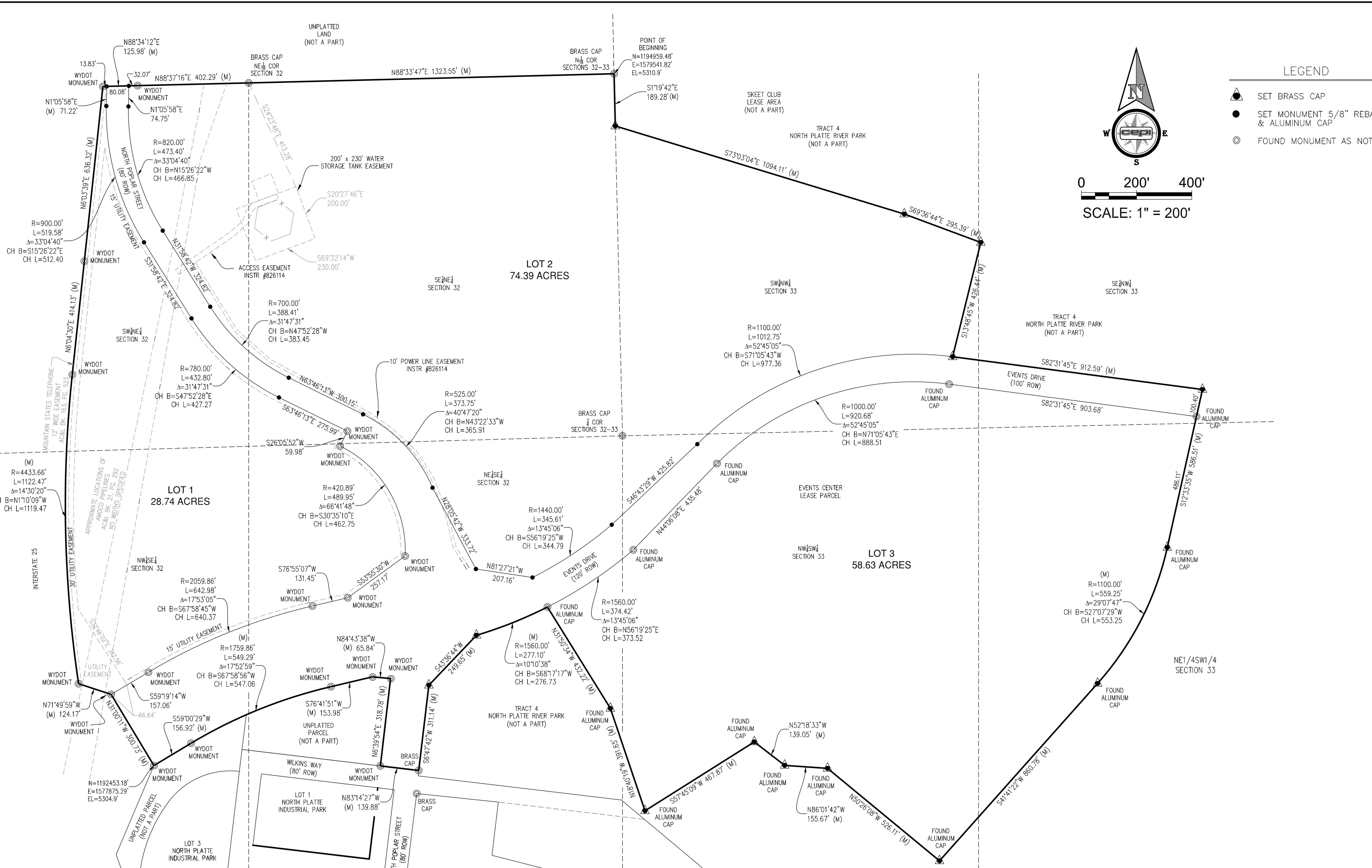

- NOTES**
- ERROR OF CLOSURE EXCEEDS 1:517,423.
 - BASIS OF BEARINGS IS THE WYOMING STATE PLANE COORDINATE SYSTEM, EAST CENTRAL ZONE, NAD 1983/2011.
 - THE CONVERGENCE ANGLE AT THE POINT OF BEGINNING IS 00°40'41.88", AND THE COMBINED FACTOR IS 0.99976532.
 - ALL DISTANCES ARE GROUND.
 - ELEVATIONS SHOWN HEREON ARE BASED ON NAVD 88 DATUM AND ARE NOT MEANT TO BE USED AS BENCHMARKS.

CERTIFICATE OF SURVEYOR

STATE OF WYOMING }
COUNTY OF NATRONA }SS

I, WILLIAM R. FEHRINCER, A REGISTERED PROFESSIONAL LAND SURVEYOR, LICENSE NO. 5528, DO HEREBY CERTIFY THAT THIS PLAT WAS MADE FROM NOTES TAKEN DURING AN ACTUAL SURVEY MADE UNDER MY DIRECT SUPERVISION IN SEPTEMBER, 2021 AND THAT THIS PLAT, TO THE BEST OF MY KNOWLEDGE AND BELIEF, CORRECTLY AND ACCURATELY REPRESENTS SAID SURVEY. ALL DIMENSIONS ARE EXPRESSED IN FEET AND DECIMALS THEREOF. COURSES ARE REFERRED TO THE WYOMING STATE PLANE COORDINATE SYSTEM, EAST CENTRAL ZONE, NAD 1983/2011, CITY OF CASPER GIS SYSTEM. ALL BEING TRUE AND CORRECT TO THE BEST OF MY KNOWLEDGE AND BELIEF.

THE FOREGOING INSTRUMENT WAS ACKNOWLEDGED BEFORE ME BY WILLIAM R. FEHRINCER
THIS _____ DAY OF _____, 2021.

WITNESS MY HAND AND OFFICIAL SEAL.
MY COMMISSION EXPIRES _____

NOTARY PUBLIC

APPROVALS

APPROVED BY THE CITY OF CASPER PLANNING AND ZONING COMMISSION OF CASPER, WYOMING
THIS _____ DAY OF _____, 2021.

ATTEST: _____ SECRETARY _____ CHAIRMAN

APPROVED BY THE CITY COUNCIL OF CASPER, WYOMING BY ORDINANCE NO. _____, DULY PASSED,
ADOPTED AND APPROVED THIS _____ DAY OF _____, 2021.

ATTEST: _____ CITY CLERK _____ MAYOR

INSPECTED AND APPROVED THIS _____ DAY OF _____, 2021.

INSPECTED AND APPROVED THIS _____ DAY OF _____, 2021.

CITY ENGINEER
CITY SURVEYOR

CITY OF CASPER
200 NORTH DAVID
CASPER, WYOMING 82601

STEVEN K. FREEL - MAYOR

THE FOREGOING INSTRUMENT WAS ACKNOWLEDGED BEFORE ME BY STEVEN K. FREEL, MAYOR
OF THE CITY OF CASPER, THIS _____ DAY OF _____, 2021.

WITNESS MY HAND AND OFFICIAL SEAL.
MY COMMISSION EXPIRES _____

NOTARY PUBLIC

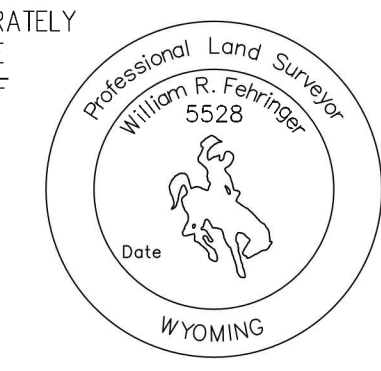

VICINITY MAP
NO SCALE

ORDINANCE NO. 16-22

AN ORDINANCE APPROVING THE ANNEXATION OF 2.0-ACRES DESCRIBED AS TRACT 8, DOWLER NO. 2 ADDITION, ESTABLISHING THE ZONING OF SAID PARCEL AS C-2 (GENERAL BUSINESS), AND REZONING 8.2-ACRES DESCRIBED AS THE PARADISE ACRES ADDITION TO C-2 (GENERAL BUSINESS)

WHEREAS, Paradise Valley Christian Church has applied to annex 2.0 acres, located at 3025 Paradise Drive, and described as Tract 8, Dowler No. 2 Addition; and,

WHEREAS, the applicant has applied to zone Tract 8, Dowler No. 2 Addition as C-2 (General Business); and,

WHEREAS, the applicant has also applied to rezone 8.2-acres of property located at 3041 Paradise Drive, described as the Paradise Acres Addition, as C-2 (General Business); and,

WHEREAS, a petition requesting annexation has been signed by a majority of the landowners owning a majority of the area sought to be annexed, excluding public streets and alleys and tax exempt property, and said petition has been submitted to the City of Casper for approval pursuant to Section 15-1-403 of the Wyoming State Statutes, as amended; and,

WHEREAS, an annexation report will be completed prior to final approval of the annexation, in accordance with Section 15-1-402 of the Wyoming State Statutes, as amended; and,

WHEREAS, the City of Casper Planning and Zoning Commission recommended that the Council approve the annexation and the zoning, as requested, following a public hearing on August 18, 2022.

NOW, THEREFORE, BE IT ORDAINED BY THE GOVERNING BODY OF THE CITY OF CASPER, WYOMING:

SECTION 1:

The annexation of 2.0 acres, located at 3025 Paradise Drive, and described as Tract 8, Dowler No. 2 Addition, is hereby approved, said property is included within the corporate limits of the City of Casper and all rights, privileges, and duties pertaining to such inclusion shall apply to said development and the inhabitants thereof.

SECTION 2:

The 2.0 acres described as Tract 8, Dowler Addition No. 2 is hereby zoned C-2 (General Business).

SECTION 3:

The 8.2-acres described as the Paradise Acres Addition is hereby rezoned from PUD (Planned Unit Development) to C-2 (General Business).

SECTION 4:

All utility franchises shall be furnished a copy of this ordinance, and other information required by the franchises, as official notice of the expansion of the City limits.

SECTION 5:

This ordinance shall, pursuant to W. S. § 15-1-408, be in full force and effect on the 21st business day following third reading approval by the City Council, and following publication.

PASSED on 1st reading the 20^m day of Sept., 2022.

PASSED on 2nd reading the ____ day of _____, 2022.

PASSED, APPROVED, AND ADOPTED on 3rd and final reading the ____ day of _____, 2022.

APPROVED AS TO FORM:

Wallie Tremel

ATTEST:

CITY OF CASPER, WYOMING
A Municipal Corporation

Fleur Tremel
City Clerk

Ray Pacheco
Mayor

PV Christian Church Annexation/Zoning Request



ORDINANCE NO. 14-22

AN ORDINANCE CORRECTING A SCRIVENER'S ERROR IN THE LEGAL DESCRIPTION OF ORDINANCE NO. 34-19 PERTAINING TO THE MISTAKEN INCLUSION, VIA ANNEXATION, OF THE WEST HALF OF LOTS 26 & 27, SOUTH GARDEN CREEK ACRES NO. 2 ADDITION IN THE CASPER MUNICIPAL LIMITS.

WHEREAS, the City of Casper, Wyoming, passed and enacted Ordinance No 34-19 following the third reading on January 20, 2020, which approved the City-initiated annexation of multiple properties along the west side of South Poplar Street, and south of West 50th Street; and,

WHEREAS, the legal description of the lots included in the City-initiated annexation mistakenly included two (2) properties, described as the west half of Lots 26 and 27, and Lots 28 and 29, South Garden Creek Acres No. 2 Addition, that were not intended to be annexed; and,

WHEREAS, the property owners of 5075 Yesness Lane, more particularly described as the West Half of Lots 28 & 29, South Garden Creek Acres #2, has submitted, in writing, their acceptance/approval of the previous, unintended annexation of their property into the City of Casper; and,

WHEREAS, the property owner of the West Half of Lots 26 & 27, South Garden Creek Acres No. 2 Addition has submitted, in writing, his request that the City correct the legal description of the annexation to clarify that his property was not annexed, and is not intended to be located within the City of Casper Municipal Limits at this time; and,

WHEREAS, 5075 Yesness Lane, more particularly described as the West Half of Lots 28 and 29, South Garden Creek Acres #2, has municipal water service, and a commitment to annex the property was executed and recorded with the Natrona County Clerk's Office as Instrument # 585194; and,

WHEREAS, the property described as the West Half of Lots 26 and 27, South Garden Creek Acres No. 2 Addition is currently undeveloped, with no City-provided utilities serving the site; and,

WHEREAS, upon correction of the scrivener's error, and the reversion of the West Half of Lots 26 and 27, South Garden Creek Acres No. 2 Addition to the County, prior to being eligible for or obtaining City utilities (*water and/or sewer*) in the future, the property owner of record at that time will be required to annex into the City of Casper, pursuant to established City policy set forth in Resolution #19-77, and will also be required, at that time, to commit to pay applicable City of Casper application fees, tap fees, and design/construction fees for customary

public improvements to adjacent public streets (*Yesness Lane and/or South Poplar Street*) to complete said street(s) to City of Casper design/construction standards; and,

WHEREAS, based on the written requests of the two (2) property owners affected by the erroneous legal description in Ordinance 34-19, it is the intent of this Ordinance to correct said scrivener's error.

NOW THEREFORE, BE IT RESOLVED BY THE GOVERNING BODY OF THE CITY OF CASPER, WYOMING: That Ordinance No. 34-19 is hereby amended to strike/delete the legal description found in the first recital, and to amend it to correctly read as follows:

- E ½, Tracts 34 and 35, South Garden Creek Acres No. 2 Addition;
- Tracts 14-25, Inclusive, South Garden Creek Acres No. 2 Addition;
- E ½, Tracts 26 & 27, South Garden Creek Acres No. 2 Addition;
- Tracts 28-31, Inclusive, South Garden Creek Acres No. 2 Addition;
- Tracts 1-10, and the South Portion of 11 (*Amended Portion of Tract 11 remaining after incorporation of the North Portion of Tract 11 into the Vigneri Addition to the City of Casper – Instrument # 894596*), South Garden Creek Acres Addition.

PASSED ON FIRST READING THIS 6th day of Sept., 2022

PASSED ON SECOND READING THIS 20th day of Sept., 2022

PASSED ON THIRD READING THIS ____ day of _____, 2022

APPROVED AS TO FORM:

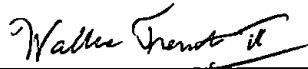

ATTEST:

Fleur Tremel
City Clerk

CITY OF CASPER, WYOMING
A Municipal Corporation

Ray Pacheco
Mayor

September 6, 2022

MEMO TO: J. Carter Napier, City Manager 

FROM: Andrew Beamer, P.E., Public Services Director
Cynthia M. Langston, Solid Waste Division Manager
Alex Sveda, P.E., City Engineer
Steven Stolte, E.I.T., Associate Engineer I

SUBJECT: Authorizing an Agreement with Automation & Electronics Inc., in the amount of \$83,270.00 for the Casper Regional Landfill Cell 5 Leachate Controls, Project No. 21-012B.

Meeting Type & Date:
Regular Council Meeting
September 20, 2022

Action Type:
Resolution

Recommendation:
That Council, by resolution, authorize an agreement with Automation & Electronics Inc., for the Casper Regional Landfill (CRL) Cell 5 Leachate Controls, Project No. 21-012B, in the amount of \$83,270.00.

Summary:
On September 2, 2022, the City of Casper received One (1) proposal for the (CRL) Cell 5 Leachate Controls, Project No. 21-012B. The proposal received is as follows:

Contractor	Location	Total Base Bid
Automation & Electronics Inc.	Casper, Wyoming	\$83,270.00

The project includes system control integration of the new CRL Cell 5 leachate system and connection of the secondary electrical to the Cell 5 leachate riser and enclosure.

In 2016, Golder Associates designed and installed the CRL leachate control system for CRL Cells 1 through 4. Golder Associates has recommended Automation Electronics, Inc., for this work because they are a local firm with knowledge of the system and have provided maintenance on it since 2017.

City Engineering Staff have reviewed the proposal and recommend that Automation & Electronics, Inc., be awarded the work due to their full understanding of the project and their ability to complete it successfully.

The work is scheduled to be substantially completed by December 2022.

Financial Considerations:

Funding for this project will be Funding for this project will be from Munis Project 2060022010 as part of Improvements Other than Bldgs.

Oversight/Project Responsibility:

Steven Stolte, E.I.T., Associate Engineer I

Attachments:

Resolution

Professional Services Contract

CONTRACT FOR PROFESSIONAL SERVICES

PART I - AGREEMENT

This Contract for Professional Services ("Contract") is entered into on this 04 day of October, 2022, by and between the following parties:

1. The City of Casper, Wyoming, a Wyoming municipal corporation, 200 North David Street, Casper, Wyoming 82601 ("City").
2. Automation & Electronics Inc., 610 W Platte Rd, Casper, Wyoming 82601 ("Contractor").

Throughout this document, the City and the Contractor may be collectively referred to as the "parties."

RECITALS

A. The City is undertaking a project to extend the leachate forcemain and upgrade the leachate controls.

B. The project requires professional services for the design and installation of the forcemain and the controls for the leachate system.

C. The Contractor represents that it is ready, willing, and able to provide the professional services to City as required by this Contract.

D. The City desires to retain the Contractor for such services.

NOW, THEREFORE, in consideration of the covenants and conditions set forth herein to be performed, the parties agree as follows:

1. SCOPE OF SERVICES:

The Contractor shall perform the following services in connection with and respecting the project:

See Exhibit A for the scope of work attached hereto and hereby made part of this Contract.

2. TIME OF PERFORMANCE:

The services of the Contractor shall be undertaken and completed on or before the 31 day of December 2022.

3. COMPENSATION:

In consideration of the performance of services rendered under this Contract, the Contractor shall be compensated for services performed in accordance with paragraph 1, not to exceed a sum of Eighty-Three Thousand Two Hundred Seventy and 00/100 Dollars (\$83,270.00).

4. METHOD OF PAYMENT:

Payment will be made following completion of the terms set forth herein and receipt of an itemized invoice, certified under penalty of perjury, from the Contractor for services rendered in conformance with the Contract, and following approval by the Casper City Council. The invoice for payment must specify the correct amount due; that the Contractor has performed the services rendered under this Contract, in conformance with the Contract, and that it is entitled to receive the amount requested under the terms of the Contract.

If amounts owed by the Contractor to the City for any goods, services, licenses, permits or any other items or purpose remain unpaid beyond the City's general credit policy, those amounts may be deducted from the payment being made by the City to the Contractor pursuant to this Contract.

5. TERMS AND CONDITIONS.

This Contract is subject to and incorporates the provisions attached hereto as PART II -- GENERAL TERMS AND CONDITIONS

6. EXTENT OF CONTRACT:

This Contract represents the entire and integrated Agreement between the City and the Contractor, and supersedes all prior negotiations, representations, or agreements, either written or oral. The Contract may be amended only by written instrument signed by both the City's and the Contractor's authorized representatives.

The City and the Contractor each individually represent that they have the requisite authority to execute this Contract and perform the services described in this Contract.

IN WITNESS WHEREOF, the undersigned duly authorized representatives of the parties have executed this Contract as of the day and year above.

APPROVED AS TO FORM

ATTEST

CITY OF CASPER, WYOMING
A Municipal Corporation

Fleur Tremel
City Clerk

Ray Pacheco
Mayor

WITNESS

CONTRACTOR
Automation & Electronics Inc.

By: _____

DocuSigned by:
By: Thomas Hood
4E5F9E7E3867431...

Printed Name: _____

Printed Name: Thomas Hood

Title: _____

Title: Sr Systems Eng

CONTRACT FOR PROFESSIONAL SERVICES

PART II - GENERAL TERMS AND CONDITIONS

1. TERMINATION OF CONTRACT:

1.1 The City may terminate this Contract anytime by providing thirty (30) days written notice to Contractor of intent to terminate said Contract. In such event, all finished or unfinished documents, data, studies and reports prepared by the Contractor under this Contract shall, at the option of the City, become its property, and the Contractor shall be entitled to receive just and equitable compensation for any satisfactory work completed on such documents.

1.2 Notwithstanding the above, the Contractor shall not be relieved of liability to the City for damages sustained by the City, by virtue of termination of the Contract by Contractor, or any breach of the Contract by the Contractor, and the City may withhold any payments to the Contractor for the purpose of setoff until such time as the exact amount of damages due the City from the Contractor are determined.

2. CHANGES:

The City may, from time to time, request changes in the scope of the services of the Contract. Such changes, including any increase or decrease in the amount of the Contractor's compensation, which are mutually agreed upon between the City and the Contractor, shall be incorporated in written amendments to this Contract. There shall be no increase in the amount of Contractor's compensation unless approved by Resolution adopted by City.

3. ASSIGNABILITY:

The Contractor shall not assign any interest in this Contract, and shall not transfer any interest in the same (whether by assignment or novation) without the prior written approval of the City: provided, however, that claims for money due or to become due to the Contractor from the City under this Contract may be assigned to a bank, trust company, or other financial institution, or to a trustee in bankruptcy, without such approval. Notice of any assignment or transfer shall be furnished to the City within five (5) business days of any assignment or transfer.

4. AUDIT:

The City and its representatives shall have access and obtain at its discretion, copies to any books, documents, papers, electronic data and records of the Contractor, which are pertinent to this Contract. The Contractor shall immediately, upon receiving written instruction from the City, provide to any independent auditor or accountant all books, documents, papers, electronic data and recordings of the Contractor which are pertinent to

this Contract. The Contractor shall cooperate fully with any such independent auditor or accountant during the entire course of any audit authorized by the City.

5. EQUAL EMPLOYMENT OPPORTUNITY:

In carrying out the program, the Contractor shall not discriminate against any employee or applicant for employment because of race, color, religion, sex, national origin, or disability. The Contractor shall take affirmative action to ensure that applicants for employment are employed, and that employees are treated during employment, without regard to their race, color, religion, sex, national origin, or disability. Such action shall include, but not be limited to, the following: employment upgrading, demotion, or transfer; recruitment or recruitment advertising; layoff or termination; rates of pay or other forms of compensation; and selection for training, including apprenticeship. The Contractor shall post in conspicuous places, available to employees and applicants for employment, notices required by the government setting forth the provisions of this nondiscrimination clause. The Contractor shall state that all qualified applicants will receive consideration for employment without regard to race, color, religion, sex, national origin, or disability.

6. OWNER OF PROJECT MATERIALS:

All finished or unfinished documents, data, studies, surveys, drawings, maps, models, photographs, films, duplicating plates, and reports prepared by the Contractor under this Contract shall be considered the property of the City, and upon completion of the services to be performed, or termination of this Contract, they will be turned over to the City provided that, in any case, the Contractor may, at no additional expense to the City, make and retain such additional copies thereof as Contractor desires for its own use; and provided further, that in no event may any of the documents, data, studies, surveys, drawings, maps, models, photographs, films, duplicating plates, or other reports retained by the Contractor be released to any person, agency, corporation, or organization without the written consent of the City.

7. FINDINGS CONFIDENTIAL:

All reports, information, data, etc., given to or prepared, or assembled by the Contractor under this Contract are confidential and shall not be made available to any individual or organization by the Contractor without the prior written consent of the City.

8. GOVERNING LAW AND VENUE:

This Contract shall be governed by the laws of the State of Wyoming. The Courts of the State of Wyoming shall have jurisdiction over this Contract and the parties. The venue shall be the Seventh Judicial District, Natrona County, Wyoming. The Contractor shall also comply with all applicable laws, ordinances, and codes of the local, state, or federal governments and shall not trespass on any public or private property in performing any of the work embraced by this Contract.

9. PERSONNEL:

The Contractor represents that it has, or will secure, all personnel required in performing the services under this Contract. Such personnel shall not be employees of the City. All of the services required shall be performed by the Contractor, or under its supervision, and all personnel engaged in the work shall be fully qualified. All personnel employed by Contractor shall be employed in conformity with applicable local, state or federal laws.

10. SUBCONTRACTOR:

The Contractor shall not employ any subcontractor to perform any services in the scope of this project, unless the subcontractor is approved in writing by the City. Any approved subcontractor shall be paid by the Contractor.

11. INSURANCE AND INDEMNIFICATION:

A. **Prior to the commencement of work, Contractor shall procure and maintain for the duration of the Contract insurance against claims for injuries to persons or damages to property which may arise from or in connection with the performance of the work hereunder by the Contractor, its subcontractors, agents, representatives, or employees.**

B. *Minimum Scope and limit of Insurance.*

Coverage shall be at least as broad as:

1. Commercial General Liability (CGL): Insurance Services Office Form CG 00 01 covering CGL on an "occurrence" basis, including products and completed operations, property damage, bodily injury and personal & advertising injury with limits no less than the sum of Two Hundred Fifty Thousand Dollars (\$250,000) to any claimant for any number of claims arising out of a single transaction or occurrence; or the sum of Five Hundred Thousand Dollars (\$500,000) for all claims arising out of a single transaction or occurrence. If a general aggregate limit applies, the general aggregate limit shall apply separately to this project/location (ISO CG 25 03 or 25 04) or the general aggregate limit shall be twice the required occurrence limit). The CGL policy shall be endorsed to contain Employers Liability/Stop Gap Coverage
2. Automobile Liability: Insurance Services Office Form Number CA 0001 covering Code 1 (any auto), or if Contractor has no owned autos, Code 8 (hired) and 9 (non-owned), with limit no less than Five Hundred Thousand (\$500,000) per accident for bodily injury and property damage.
3. Workers' Compensation: as required by the State of Wyoming with Statutory Limits.

4. Professional Liability (Errors and Omissions) Insurance appropriate to the Contractor's profession, with limit no less than the sum of Two Million Dollars (\$2,000,000) to any claimant for any number of claims arising out of a single transaction or occurrence; or the sum of Two Million Dollars (\$2,000,000) for all claims arising out of a single transaction or occurrence. If a general aggregate limit applies, the general aggregate limit shall apply separately to this project/location.

C. *Higher Limits.* If the Contractor maintains broader coverage and/or higher limits than required under this Agreement, then the City shall be entitled to the broader coverage and/or the higher limits maintained by the Contractor. Any available insurance proceeds in excess of the specified minimum limits of insurance and coverage shall be available to the City.

D. *Other Insurance Provisions*

The insurance policies are to contain, or be endorsed to contain, the following provisions:

1. *Additional Insured Status*

The City, its officers, elected and appointed officials, employees, agents and volunteers are to be covered as additional insureds on the CGL policy with respect to liability arising out of work or operations performed by or on behalf of the Contractor including materials, parts, or equipment furnished in connection with such work or operations. General liability coverage shall be provided in the form of an endorsement to the Contractor's insurance (at least as broad as ISO Form CG 20 10 11 85 or both CG 20 10, CG 20 26, CG 20 33, or CG 20 38 and CG 20 37 forms if later revisions used).

2. *Primary Coverage*

For any claims related to this Contract, the Contractor's insurance coverage shall be primary and non-contributory insurance coverage at least as broad as ISO CG 20 01 04 13 as respects the Contractor as respects the City, its officers, elected and appointed officials, employees, agents and volunteers.

3. *Notice of Cancellation*

Each insurance policy required above shall state that coverage shall not be canceled, materially changed, or reduced, except with notice to the City. Such notice to the City shall be provided in a commercially reasonable time.

4. *Waiver of Subrogation*

Contractor hereby grants to City a waiver of any right to subrogation which any insurer of said Contractor may acquire against the City by virtue of the payment of any loss under such insurance. Contractor agrees to obtain any endorsement that may be necessary to affect this waiver of subrogation, but this provision applies

regardless of whether or not the City has received a waiver of subrogation endorsement from the insurer.

5. *Deductibles and Self-Insured Retentions*

Contractor has two options regarding deductibles and self-insured retentions:

- a. Option 1: Any deductibles or self-insured retentions must be declared to and approved by the City. Unless otherwise approved by the City in writing, any deductible may not exceed Ten Thousand Dollars (\$10,000). Unless otherwise approved in writing by the City, self-insured retentions may not exceed Ten Thousand Dollars (\$10,000), and the City may require the Contractor to provide proof of ability to pay losses and related investigations, claim administration, and defense expenses within the retention.
- b. Option 2: Contractor shall carry insurance with terms that require its insurance company to pay the full value of a covered claim from the first dollar of coverage, even if the Contractor is unable to pay any deductible or self-insured retention amount(s) required by the insurance policy. Contractor shall provide a written endorsement from its insurance carrier that such insurance coverage is in place, and shall keep such coverage in place during the term of this Contract and any subsequent time period required for claims made policies.

6. *Acceptability of Insurers*

Insurance is to be placed with insurers with a current A.M. Best's rating of no less than A:VII, unless otherwise agreed to in writing by the City.

7. *Claims Made Policies*

If any of the required policies provide coverage on a claims-made basis:

- a. The Retroactive Date must be shown and must be before the date of the Contract or the beginning of Contract work.
- b. Insurance must be maintained and evidence of insurance must be provided *for at least five (5) years after completion of the contract of work*. However, Contractor's liabilities under this Contract shall not be deemed limited in any way by the insurance coverage required.
- c. If coverage is canceled or non-renewed, and not *replaced with another claims-made policy form with a Retroactive Date* prior to the Contract effective date, the Contractor must purchase "extended reporting" coverage for a minimum of *five (5) years* after completion of contract work and at all times thereafter until the applicable statute of limitations runs.

8. *Verification of Coverage*

Contractor shall furnish the City with original certificates of insurance including all required amendatory endorsements or copies of the applicable policy language effecting coverage required by this clause and a copy of the Declarations and Endorsement Page of the CGL policy listing all policy endorsements to the City before work begins. All certificates and endorsements are to be received and approved by the City before work commences. However, failure to obtain the required documents prior to the work beginning shall not waive the Contractor's obligation to provide them. The City reserves the right to require complete, certified copies of all required insurance policies, including endorsements required by these specifications, at any time.

9. *Subcontractors*

Contractor shall require and verify that all subcontractors maintain insurance meeting all the requirements stated herein, and Contractor shall ensure that the City is an additional insured on insurance required from subcontractors.

10. *Special Risks or Circumstances*

City reserves the right to reasonably modify these requirements, including limits, based on the nature of the risk, prior experience, insurer, coverage, or other special circumstances.

E. Contractor agrees to indemnify the City, the City's employees, elected officials, appointed officials, agents, and volunteers, and all additional insured and hold them harmless from all liability for damages to property or injury to or death to persons, including all reasonable costs, expenses, and attorney's fees incurred related thereto, to the extent arising from negligence, fault or willful and wanton conduct of the Contractor and any subcontractor thereof.

12. LIMITATION OF LIABILITY:

In no event shall the City, the City's employees, elected officials, appointed officials, or agents be liable under this Contract to Contractor or any third party for consequential, indirect, incidental, special, exemplary, punitive or enhanced damages or lost profits or revenues, or diminution in value, arising out of, relating to, or in connection with any breach of this Contract, regardless of (a) whether such damages were foreseeable (b) whether or not the Contractor was advised of the possibility of such damages and (c) the legal or equitable theory (contract, tort, or otherwise) upon which the claim is based.

13. INTENT:

Contractor represents that it has read and agrees to the terms of this Contract and further agrees that it is the intent of the parties that Contractor shall perform all of the services for the compensation set forth in this Contract. Contractor also agrees that it is the specific intent of the parties, and a material condition of this Contract, that it shall not be entitled to

compensation for other services rendered unless specifically authorized by the City by Resolution of its governing body. Contractor agrees that it has carefully examined the Scope of Services, and that the compensation is adequate for performance of this Contract.

14. WYOMING GOVERNMENTAL CLAIMS ACT:

The City does not waive any right or rights it may have pursuant to the Wyoming Governmental Claims Act, Wyoming Statutes Section 1-39-101 et seq., and the City specifically reserves the right to assert any and all rights, immunities, and defenses it may have pursuant to the Wyoming Governmental Claims Act.

15. NO THIRD PARTY BENEFICIARY RIGHTS:

The parties to this Contract do not intend to create in any other individual or entity the status of third-party beneficiary, and this Contract shall not be construed so as to create such status. The rights, duties and obligations contained in this Contract shall operate only between the parties to this Contract, and shall inure solely to the benefit of the parties to this Contract. The parties to this Contract intend and expressly agree that only parties signatory to this Contract shall have any legal or equitable right to seek to enforce this Contract, to seek any remedy arising out of a party's performance or failure to perform any term or condition of this Contract, or to bring an action for the breach of this Contract.

16. FORCE MAJEURE:

Neither party shall be liable for failure to perform under this Contract if such failure to perform arises out of causes beyond the control and without the fault or negligence of the nonperforming party. Such causes may include, but are not limited to, acts of God or the public enemy, fires, floods, epidemics, pandemics, quarantine restrictions, freight embargoes, and unusually severe weather. This provision shall become effective only if the party failing to perform immediately notifies the other party of the extent and nature of the problem, limits delay in performance to that required by the event, and takes all reasonable steps to minimize delays.

17. ELECTRONIC SIGNATURES:

The parties understand and agree that they have the right to execute this Contract through paper or through electronic signature technology, which is in compliance with Wyoming and federal law governing electronic signatures. The parties agree that to the extent they sign electronically, their electronic signature is the legally binding equivalent to their handwritten signature. Whenever they execute an electronic signature, it has the same validity and meaning as their handwritten signature. They will not, at any time in the future, repudiate the meaning of their electronic signature or claim that their electronic signature is not legally binding. They agree not to object to the admissibility of this Contract as an electronic record, or a paper copy of an electronic document, or a paper copy of a document bearing an electronic signature, on the grounds that it is an electronic record or electronic

signature or that it is not in its original form or is not an original. Each party will immediately request that their electronic signature be revoked in writing if they discover or suspect that it has been or is in danger of being lost, disclosed, compromised or subjected to unauthorized use in any way. If either party would like a paper copy of this Contract, they may request a copy from the other party, and the other party shall provide it.



**Automation
Electronics**

2 September, 2022

Alex Sveda, P.E., L.S.I.
City Engineer
City of Casper
200 N. David St.
Casper, WY 82601

Reference: City of Casper Landfill Leachate Collection Updated Quote

Alex

We are pleased to offer the following work plan. Our scope includes the following equipment and services:

1. Motor starter panel
2. Secondary power transformer
3. 480/277V 3Phase Breaker panel with required breakers
4. 240/120V breaker panel with required breakers.
5. Rosemount Mag Meter
- 6 RTU w/ front panel display
7. RF 485 communication extension package between Site 4 and Site 5
8. Installation services consist of the following.
 - a. Supply, perform mounting of 480V 100A 4W Breaker panel with the termination of load wiring
 - b Supply, perform mounting of Power Transformer with the termination of load wiring
 - c. Supply, perform mounting of 120V Breaker panel with the termination of wiring
 - d. Supply, perform mounting of Starter Panel with external power plug receptacle
 - e Installation of Motor power cable connector on the supplied cable
 - f. Supply, perform mounting of RTU with the termination of status input /output/analog wiring
 - g. Supply, perform mounting of 485 Radio Extension in Well 4 control panel
 - h. Supply, perform mounting of service outlet
 - i. Supply, perform termination of Mag meter wiring, mounting by others.

P O Box 2670 • Casper, Wyoming 82602-2670
610 Platte Road • Casper, Wyoming 82601

FAX (307) 234-4956

Phone (307) 234-9311

EXHIBIT A

9. Programming services for modification of communication at Host gateway
10. Commissioning services for system on site.
- 11 The site as-built drawing set.
12. Provide wire for Installation in provided conduit run and termination of primary power run to Site 5 from new panel
13. Installation of all panels on UniStrut rack
14. Provide and install heat tape on exposed piping
15. Provide and install 4 each LED lights at site 5.

Pricing for the scope listed is \$75,270.00

Due to volatility of current supply chains the delivery date can be provide at the time of order.

As discussed we would recommend the acquisition of spare parts to support the existing equipment and the new installation. These would extend the service life of the system considerably.

Spares to be acquired are the following:

1. 3 each Scadapack Controllers
2. 2 each Vision 10 displays.

Pricing for these spares would be \$8000.00

The other components in the system are available from various manufacturers.

These prices are current but with supply chain situations future pricing may change up or down.

Thank you for the opportunity to submit this quote.

Regards,

Thomas Hool

Sr. Systems Engineer
Automation Electronics
307-234-9311

STATE OF WYOMING * SECRETARY OF STATE
EDWARD A. BUCHANAN
BUSINESS DIVISION

Herschler Bldg East, Ste.100 & 101, Cheyenne, WY 82002-0020

Phone 307-777-7311

Website: <https://sos.wyo.gov> · Email: business@wyo.gov

Filing Information



Please note that this form CANNOT be submitted in place of your Annual Report.

Name	Automation & Electronics, Inc.		
Filing ID	1980-000078726		
Type	Profit Corporation	Status	Active

General Information

Old Name		Sub Status	Current
Fictitious Name		Standing - Tax	Good
		Standing - RA	Good
Sub Type		Standing - Other	Good
Formed in	Wyoming	Filing Date	02/26/1959 12:00 AM
Term of Duration	Perpetual	Delayed Effective Date	
		Inactive Date	

Share Information

Common Shares	25,000	Preferred Shares		Additional Stock	Y
Par Value	0.0000	Par Value	0.0000		

Principal Address

610 Platte Road
Casper, WY 82601

Mailing Address

P.O. Box 2670
Casper, WY 82602

Registered Agent Address

Robert S Tanner
610 Platte Rd
PO Box 2670
Casper, WY 82601

Parties

Type	Name / Organization / Address
-------------	--------------------------------------

Notes

Date	Recorded By	Note
-------------	--------------------	-------------

Filing Information



Please note that this form CANNOT be submitted in place of your Annual Report.

Name	Automation & Electronics, Inc.		
Filing ID	1980-000078726		
Type	Profit Corporation	Status	Active

Most Recent Annual Report Information

Type	Original	AR Year	2022
License Tax	\$2,137.19	AR Exempt	N
AR Date	2/10/2022 11:52 AM		
Web Filed	N		

Officers / Directors

Type	Name / Organization / Address
President	HENRY TANNER 2925 CROYDEN DRIVE CASPER, WY 82609
Secretary	MIA KAMBORIS 3550 GANNETT ST CASPER, WY 82609
Treasurer / Director	ROBERT S TANNER 1501 NOTTINGHAM DR CASPER, WY 82609

Principal Address

610 Platte Road
Casper, WY 82601

Mailing Address

P.O. Box 2670
Casper, WY 82602

Annual Report History

Num	Status	Date	Year	Tax
00315280	Original	01/01/1800	1995	\$400.00
00335109	Original	01/01/1800	1996	\$25.00
00360759	Original	01/01/1800	1997	\$25.00
00383943	Original	01/01/1800	1998	\$25.00
00410971	Original	01/06/1999	1999	\$25.00
00439521	Original	01/06/1999	2000	\$25.00
00471908	Original	01/09/2001	2001	\$50.00
00509231	Original	01/09/2002	2002	\$50.00
00557090	Original	01/07/2003	2003	\$50.00
00599233	Original	12/31/2003	2004	\$50.00
00646195	Original	01/11/2005	2005	\$50.00
00694538	Original	01/10/2006	2006	\$50.00
00746919	Original	01/03/2007	2007	\$50.00
00839618	Original	01/06/2008	2008	\$50.00
Principal Address 1 Changed From: P.O. Box 3319 To: 111 Big Horn Road				
00964503	Original	01/11/2009	2009	\$50.00

Filing Information



Please note that this form CANNOT be submitted in place of your Annual Report.

Name **Automation & Electronics, Inc.**

Filing ID **1980-000078726**

Type Profit Corporation Status Active

01114090	Original	02/04/2010	2010	\$50.00
01282346	Original	02/06/2011	2011	\$50.00
01478935	Original	02/01/2012	2012	\$2,171.44
01782377	Original	02/07/2013	2013	\$3,032.85
01984063	Original	02/19/2014	2014	\$4,427.12

Principal Address 1 Changed From: 111 Big Horn Rd To: 610 Platte Road

02188217	Original	02/25/2015	2015	\$4,269.21
02427389	Original	02/23/2016	2016	\$3,970.91
02719747	Original	02/22/2017	2017	\$2,862.38
03362020	Original	02/27/2018	2018	\$2,690.28
04249909	Original	02/19/2019	2019	\$2,644.14
05529493	Original	02/25/2020	2020	\$2,929.88
06091611	Original	02/10/2021	2021	\$2,235.19
07054848	Original	02/10/2022	2022	\$2,137.19

Amendment History

ID	Description	Date
2022-003661743	Common Amendment	05/03/2022
2022-003548463	Delinquency Notice - Tax	02/02/2022
2021-003113124	Delinquency Notice - Tax	02/02/2021
2020-002944365	Merger - Survivor	09/30/2020
	Qualified Survivor Filing ID Changed From: 1980-000078726 To: Merger	
	Qualified Survivor Changed From: Automation & Electronics, Inc. (Wyoming) To: Merger	
	Qualified Non-survivor Filing ID Changed From: 1995-000301630 To: Merger	
	Qualified Non-survivor Changed From: Trittech, Inc. (Wyoming) To: Merger	
2020-002743048	Delinquency Notice - Tax	02/02/2020
2019-002486980	Delinquency Notice - Tax	02/02/2019
2018-002233182	Delinquency Notice - Tax	02/02/2018
2017-002008031	Delinquency Notice - Tax	02/02/2017
2016-001848951	Delinquency Notice - Tax	02/02/2016
2015-001694784	Delinquency Notice - Tax	02/02/2015
2014-001657105	RA Address Change	09/30/2014
2014-001576559	Delinquency Notice - Tax	02/02/2014

Filing Information



Please note that this form CANNOT be submitted in place of your Annual Report.

Name **Automation & Electronics, Inc.**

Filing ID **1980-000078726**

Type **Profit Corporation**

Status

Active

2013-001456049	Delinquency Notice - Tax	02/02/2013
----------------	--------------------------	------------

2012-001303576	Change of Agent	02/02/2012
----------------	-----------------	------------

Registered Agent # Changed From: 0000883 To: 0189439

Registered Agent First Name Changed From: W To: Robert

Registered Agent Middle Name Changed From: W To: S

Registered Agent Last Name Changed From: Poe To: Tanner

Registered Agent Physical Address 1 Changed From: 417 S Elm St To: 111 Big Horn Rd

Principal Address 1 Changed From: 111 Big Horn Road To: 111 Big Horn Rd

2011-000926428	Delinquency Notice - Tax	02/02/2011
----------------	--------------------------	------------

2010-000820349	Delinquency Notice - Tax	02/02/2010
----------------	--------------------------	------------

See Filing ID	Initial Filing	02/26/1959
---------------	----------------	------------

RESOLUTION NO. 22-175

A RESOLUTION AUTHORIZING CONTRACT FOR PROFESSIONAL SERVICES WITH AUTOMATION & ELECTRONICS INC., FOR THE CASPER REGIONAL LANDFILL CELL 5 LEACHATE CONTROLS, PROJECT NO. 21-012B.

WHEREAS, the City of Casper desires to extend the leachate forcemain and upgrade the controls at the Casper Regional Landfill; and,

WHEREAS, Automation & Electronics Inc., is able and willing to provide those services, specified as the Casper Regional Landfill Cell 5 Leachate Controls, Project No. 21-012B; and,

WHEREAS, it would be in the best interest of the City to expedite changes in the project by allowing the City Manager to sign change orders effecting time extensions of no more than Thirty (30) days, dollar amount changes no greater than Thirty-Five Thousand Dollars (\$35,000) and other project administration related change orders that do not substantially alter the scope of the project.

NOW, THEREFORE, BE IT RESOLVED BY THE GOVERNING BODY OF THE CITY OF CASPER, WYOMING: That the Mayor is hereby authorized and directed to execute, and the City Clerk to attest, Contract for Professional Services with Automation & Electronics Inc., for those services.

BE IT FURTHER RESOLVED: That the City Manager is hereby authorized to make verified partial payments and contract extensions throughout the project, retaining those amounts prescribed by the Contract, equal to a total amount not to Eighty-Three Thousand Two Hundred Seventy and 00/100 Dollars (\$83,270.00).

BE IT FURTHER RESOLVED: That the City Manager is hereby authorized to sign change orders effecting time extensions of no more than thirty (30) days, changes in the dollar amount of the above described Agreement not greater than the sum of Thirty-Five Thousand Dollars (\$35,000), and other project administration related change orders that do not substantially alter the scope of the project.

PASSED, APPROVED, AND ADOPTED this ____ day of _____, 2022.

APPROVED AS TO FORM:



ATTEST:

CITY OF CASPER, WYOMING
A Municipal Corporation

Fleur Tremel
City Clerk

Ray Pacheco
Mayor

THE REMAINDER OF THIS PAGE IS INTENTIONALLY LEFT BLANK

September 20, 2022

MEMO TO: J. Carter Napier, City Manager 

FROM: Andrew Beamer, P.E., Public Services Director
Alex Sveda, P.E., City Engineer
Mark Harris, P.E., Engineer II

SUBJECT: Authorizing a Contract for Professional Services with Long Building Technologies, Inc., in the Amount of \$129,960.00, for the Ford Wyoming Center Flue Replacement, Project No. 22-058.

Meeting Type & Date

Regular Council Meeting 10/18/2022

Action type

Resolution

Recommendation

That Council, by Resolution, authorize a contract for professional services with Long Building Technologies (Long), in the amount of \$129,960.00, for the Ford Wyoming Center Flue Replacement, Project No. 22-058.

Summary

The existing boiler flue within the Ford Wyoming Center has experienced surface corrosion that requires the flue to be replaced. As a part of the project, demolition and installation of the new flue system is required.

Long provides ongoing maintenance and controls support for the Ford Wyoming Center boilers. A proposal was requested from Long due to their familiarity with the boiler system. They have provided a proposal in the amount of \$129,960. The work includes a new boiler flue, additional access points in the upper level chase, and additional condensation relief drains.

City staff recommends that Long be awarded the contract for professional services for the Ford Wyoming Center Flue Replacement Project. West Plains Engineering has been procured to provide review of material submittals, comments on submittals, one observation of construction rough in, and one punch list at startup with observation.

Financial Considerations

Funding will be from the FY23 budgeted Capital Projects Fund - Improvements to Buildings- Ford Wyo Center Boiler Exhaust Venting.

Oversight/Project Responsibility

Mark Harris, P.E., Engineer II, Public Services Department.

Attachments

Contract for Professional Services
Exhibit A

CONTRACT FOR PROFESSIONAL SERVICES

PART I - AGREEMENT

This Contract for Professional Services (“Contract”) is entered into on this ____ day of _____, 2022, by and between the following parties:

1. The City of Casper, Wyoming, a Wyoming municipal corporation, 200 North David Street, Casper, Wyoming 82601 (“City”).
2. Long Building Technologies, Inc., 5001 South Zuni Street, Littleton, Colorado 80120 (“Contractor”).

Throughout this document, the City and the Contractor may be collectively referred to as the “parties.”

RECITALS

- A. The City is undertaking a project to replace the boiler flue at the Ford Wyoming Center.
- B. The project requires professional services for the demolition of the current boiler flue system and installation of a new boiler flue system.
- C. The Contractor represents that it is ready, willing, and able to provide the professional services to City as required by this Contract.
- D. The City desires to retain the Contractor for such services.

NOW, THEREFORE, in consideration of the covenants and conditions set forth herein to be performed, the parties agree as follows:

1. SCOPE OF SERVICES:

The Contractor shall perform the services in connection with and respecting the project as found in Exhibit A pages 1 through 3, attached here to and made part of this contract.

2. TIME OF PERFORMANCE:

The services of the Contractor shall be undertaken and completed on or before the 15th day of May 2023.

3. COMPENSATION:

In consideration of the performance of services rendered under this Contract, the Contractor shall be compensated for services performed in accordance with paragraph 1, not to exceed a sum of One Hundred Twenty-Nine Thousand Nine Hundred Sixty and 00/100 Dollars (\$129,960.00).

4. METHOD OF PAYMENT:

Payment will be made following completion of the terms set forth herein and receipt of an itemized invoice, certified under penalty of perjury, from the Contractor for services rendered in conformance with the Contract, and following approval by the Casper City Council. The invoice for payment must specify the correct amount due; that the Contractor has performed the services rendered under this Contract, in conformance with the Contract, and that it is entitled to receive the amount requested under the terms of the Contract.

If amounts owed by the Contractor to the City for any goods, services, licenses, permits or any other items or purpose remain unpaid beyond the City's general credit policy, those amounts may be deducted from the payment being made by the City to the Contractor pursuant to this Contract.

5. TERMS AND CONDITIONS:

This Contract is subject to and incorporates the provisions attached hereto as PART II -- GENERAL TERMS AND CONDITIONS.

6. EXTENT OF CONTRACT:

This Contract represents the entire and integrated Agreement between the City and the Contractor, and supersedes all prior negotiations, representations, or agreements, either written or oral. The Contract may be amended only by written instrument signed by both the City's and the Contractor's authorized representatives.

The City and the Contractor each individually represent that they have the requisite authority to execute this Contract and perform the services described in this Contract.

The remainder of this page is left intentionally blank

IN WITNESS WHEREOF, the undersigned duly authorized representatives of the parties have executed this Contract as of the day and year above.

APPROVED AS TO FORM

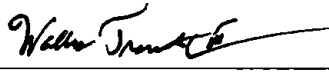

ATTEST

CITY OF CASPER, WYOMING
A Municipal Corporation

Fleur Tremel
City Clerk

Ray Pacheco
Mayor

WITNESS

CONTRACTOR
Long Building Technologies, Inc.

By: _____

By: _____

Printed Name: _____

Printed Name: _____

Title: _____

Title: _____

CONTRACT FOR PROFESSIONAL SERVICES

PART II - GENERAL TERMS AND CONDITIONS

1. TERMINATION OF CONTRACT:

1.1 The City may terminate this Contract anytime by providing thirty (30) days written notice to Contractor of intent to terminate said Contract. In such event, all finished or unfinished documents, data, studies and reports prepared by the Contractor under this Contract shall, at the option of the City, become its property, and the Contractor shall be entitled to receive just and equitable compensation for any satisfactory work completed on such documents.

1.2 Notwithstanding the above, the Contractor shall not be relieved of liability to the City for damages sustained by the City, by virtue of termination of the Contract by Contractor, or any breach of the Contract by the Contractor, and the City may withhold any payments to the Contractor for the purpose of setoff until such time as the exact amount of damages due the City from the Contractor are determined.

2. CHANGES:

The City may, from time to time, request changes in the scope of the services of the Contract. Such changes, including any increase or decrease in the amount of the Contractor's compensation, which are mutually agreed upon between the City and the Contractor, shall be incorporated in written amendments to this Contract. There shall be no increase in the amount of Contractor's compensation unless approved by Resolution adopted by City.

3. ASSIGNABILITY:

The Contractor shall not assign any interest in this Contract, and shall not transfer any interest in the same (whether by assignment or novation) without the prior written approval of the City: provided, however, that claims for money due or to become due to the Contractor from the City under this Contract may be assigned to a bank, trust company, or other financial institution, or to a trustee in bankruptcy, without such approval. Notice of any assignment or transfer shall be furnished to the City within five (5) business days of any assignment or transfer.

4. AUDIT:

The City and its representatives shall have access and obtain at its discretion, copies to any books, documents, papers, electronic data and records of the Contractor, which are pertinent to this Contract. The Contractor shall immediately, upon receiving written instruction from the City, provide to any independent auditor or accountant all books, documents, papers, electronic data and recordings of the Contractor which are pertinent to

this Contract. The Contractor shall cooperate fully with any such independent auditor or accountant during the entire course of any audit authorized by the City.

5. EQUAL EMPLOYMENT OPPORTUNITY:

In carrying out the program, the Contractor shall not discriminate against any employee or applicant for employment because of race, color, religion, sex, national origin, or disability. The Contractor shall take affirmative action to ensure that applicants for employment are employed, and that employees are treated during employment, without regard to their race, color, religion, sex, national origin, or disability. Such action shall include, but not be limited to, the following: employment upgrading, demotion, or transfer; recruitment or recruitment advertising; layoff or termination; rates of pay or other forms of compensation; and selection for training, including apprenticeship. The Contractor shall post in conspicuous places, available to employees and applicants for employment, notices required by the government setting forth the provisions of this nondiscrimination clause. The Contractor shall state that all qualified applicants will receive consideration for employment without regard to race, color, religion, sex, national origin, or disability.

6. OWNER OF PROJECT MATERIALS:

All finished or unfinished documents, data, studies, surveys, drawings, maps, models, photographs, films, duplicating plates, and reports prepared by the Contractor under this Contract shall be considered the property of the City, and upon completion of the services to be performed, or termination of this Contract, they will be turned over to the City provided that, in any case, the Contractor may, at no additional expense to the City, make and retain such additional copies thereof as Contractor desires for its own use; and provided further, that in no event may any of the documents, data, studies, surveys, drawings, maps, models, photographs, films, duplicating plates, or other reports retained by the Contractor be released to any person, agency, corporation, or organization without the written consent of the City.

7. FINDINGS CONFIDENTIAL:

All reports, information, data, etc., given to or prepared, or assembled by the Contractor under this Contract are confidential and shall not be made available to any individual or organization by the Contractor without the prior written consent of the City.

8. GOVERNING LAW AND VENUE:

This Contract shall be governed by the laws of the State of Wyoming. The Courts of the State of Wyoming shall have jurisdiction over this Contract and the parties. The venue shall be the Seventh Judicial District, Natrona County, Wyoming. The Contractor shall also comply with all applicable laws, ordinances, and codes of the local, state, or federal governments and shall not trespass on any public or private property in performing any of the work embraced by this Contract.

9. PERSONNEL:

The Contractor represents that it has, or will secure, all personnel required in performing the services under this Contract. Such personnel shall not be employees of the City. All of the services required shall be performed by the Contractor, or under its supervision, and all personnel engaged in the work shall be fully qualified. All personnel employed by Contractor shall be employed in conformity with applicable local, state or federal laws.

10. SUBCONTRACTOR:

The Contractor shall not employ any subcontractor to perform any services in the scope of this project, unless the subcontractor is approved in writing by the City. Any approved subcontractor shall be paid by the Contractor.

11. INSURANCE AND INDEMNIFICATION:

A. **Prior to** the commencement of work, Contractor shall procure and maintain for the duration of the Contract insurance against claims for injuries to persons or damages to property which may arise from or in connection with the performance of the work hereunder by the Contractor, its subcontractors, agents, representatives, or employees.

B. *Minimum Scope and limit of Insurance.*

Coverage shall be at least as broad as:

1. Commercial General Liability (CGL): Insurance Services Office Form CG 00 01 covering CGL on an "occurrence" basis, including products and completed operations, property damage, bodily injury and personal & advertising injury with limits no less than the sum of Two Hundred Fifty Thousand Dollars (\$250,000) to any claimant for any number of claims arising out of a single transaction or occurrence; or the sum of Five Hundred Thousand Dollars (\$500,000) for all claims arising out of a single transaction or occurrence. If a general aggregate limit applies, the general aggregate limit shall apply separately to this project/location (ISO CG 25 03 or 25 04) or the general aggregate limit shall be twice the required occurrence limit). The CGL policy shall be endorsed to contain Employers Liability/Stop Gap Coverage
2. Automobile Liability: Insurance Services Office Form Number CA 0001 covering Code 1 (any auto), or if Contractor has no owned autos, Code 8 (hired) and 9 (non-owned), with limit no less than Five Hundred Thousand (\$500,000) per accident for bodily injury and property damage.
3. Workers' Compensation: as required by the State of Wyoming with Statutory Limits.

4. Professional Liability (Errors and Omissions) Insurance appropriate to the Contractor's profession, with limit no less than the sum of Two Million Dollars (\$2,000,000) to any claimant for any number of claims arising out of a single transaction or occurrence; or the sum of Two Million Dollars (\$2,000,000) for all claims arising out of a single transaction or occurrence. If a general aggregate limit applies, the general aggregate limit shall apply separately to this project/location.

C. *Higher Limits.* If the Contractor maintains broader coverage and/or higher limits than required under this Agreement, then the City shall be entitled to the broader coverage and/or the higher limits maintained by the Contractor. Any available insurance proceeds in excess of the specified minimum limits of insurance and coverage shall be available to the City.

D. *Other Insurance Provisions*

The insurance policies are to contain, or be endorsed to contain, the following provisions:

1. *Additional Insured Status*

The City, its officers, elected and appointed officials, employees, agents and volunteers are to be covered as additional insureds on the CGL policy with respect to liability arising out of work or operations performed by or on behalf of the Contractor including materials, parts, or equipment furnished in connection with such work or operations. General liability coverage shall be provided in the form of an endorsement to the Contractor's insurance (at least as broad as ISO Form CG 20 10 11 85 or both CG 20 10, CG 20 26, CG 20 33, or CG 20 38 and CG 20 37 forms if later revisions used).

2. *Primary Coverage*

For any claims related to this Contract, the Contractor's insurance coverage shall be primary and non-contributory insurance coverage at least as broad as ISO CG 20 01 04 13 as respects the Contractor as respects the City, its officers, elected and appointed officials, employees, agents and volunteers.

3. *Notice of Cancellation*

Each insurance policy required above shall state that coverage shall not be canceled, materially changed, or reduced, except with notice to the City. Such notice to the City shall be provided in a commercially reasonable time.

4. *Waiver of Subrogation*

Contractor hereby grants to City a waiver of any right to subrogation which any insurer of said Contractor may acquire against the City by virtue of the payment of any loss under such insurance. Contractor agrees to obtain any endorsement that may be necessary to affect this waiver of subrogation, but this provision applies

regardless of whether or not the City has received a waiver of subrogation endorsement from the insurer.

5. *Deductibles and Self-Insured Retentions*

Contractor has two options regarding deductibles and self-insured retentions:

- a. Option 1: Any deductibles or self-insured retentions must be declared to and approved by the City. Unless otherwise approved by the City in writing, any deductible may not exceed Ten Thousand Dollars (\$10,000). Unless otherwise approved in writing by the City, self-insured retentions may not exceed Ten Thousand Dollars (\$10,000), and the City may require the Contractor to provide proof of ability to pay losses and related investigations, claim administration, and defense expenses within the retention.
- b. Option 2: Contractor shall carry insurance with terms that require its insurance company to pay the full value of a covered claim from the first dollar of coverage, even if the Contractor is unable to pay any deductible or self-insured retention amount(s) required by the insurance policy. Contractor shall provide a written endorsement from its insurance carrier that such insurance coverage is in place, and shall keep such coverage in place during the term of this Contract and any subsequent time period required for claims made policies.

6. *Acceptability of Insurers*

Insurance is to be placed with insurers with a current A.M. Best's rating of no less than A:VII, unless otherwise agreed to in writing by the City.

7. *Claims Made Policies*

If any of the required policies provide coverage on a claims-made basis:

- a. The Retroactive Date must be shown and must be before the date of the Contract or the beginning of Contract work.
- b. Insurance must be maintained and evidence of insurance must be provided *for at least five (5) years after completion of the contract of work*. However, Contractor's liabilities under this Contract shall not be deemed limited in any way by the insurance coverage required.
- c. If coverage is canceled or non-renewed, and not *replaced with another claims-made policy form with a Retroactive Date* prior to the Contract effective date, the Contractor must purchase "extended reporting" coverage for a minimum of *five (5) years* after completion of contract work and at all times thereafter until the applicable statute of limitations runs.

8. *Verification of Coverage*

Contractor shall furnish the City with original certificates of insurance including all required amendatory endorsements or copies of the applicable policy language effecting coverage required by this clause and a copy of the Declarations and Endorsement Page of the CGL policy listing all policy endorsements to the City before work begins. All certificates and endorsements are to be received and approved by the City before work commences. However, failure to obtain the required documents prior to the work beginning shall not waive the Contractor's obligation to provide them. The City reserves the right to require complete, certified copies of all required insurance policies, including endorsements required by these specifications, at any time.

9. *Subcontractors*

Contractor shall require and verify that all subcontractors maintain insurance meeting all the requirements stated herein, and Contractor shall ensure that the City is an additional insured on insurance required from subcontractors.

10. *Special Risks or Circumstances*

City reserves the right to reasonably modify these requirements, including limits, based on the nature of the risk, prior experience, insurer, coverage, or other special circumstances.

E. Contractor agrees to indemnify the City, the City's employees, elected officials, appointed officials, agents, and volunteers, and all additional insured and hold them harmless from all liability for damages to property or injury to or death to persons, including all reasonable costs, expenses, and attorney's fees incurred related thereto, to the extent arising from negligence, fault or willful and wanton conduct of the Contractor and any subcontractor thereof.

12. LIMITATION OF LIABILITY:

In no event shall the City, the City's employees, elected officials, appointed officials, or agents be liable under this Contract to Contractor or any third party for consequential, indirect, incidental, special, exemplary, punitive or enhanced damages or lost profits or revenues, or diminution in value, arising out of, relating to, or in connection with any breach of this Contract, regardless of (a) whether such damages were foreseeable (b) whether or not the Contractor was advised of the possibility of such damages and (c) the legal or equitable theory (contract, tort, or otherwise) upon which the claim is based.

13. INTENT:

Contractor represents that it has read and agrees to the terms of this Contract and further agrees that it is the intent of the parties that Contractor shall perform all of the services for the compensation set forth in this Contract. Contractor also agrees that it is the specific intent of the parties, and a material condition of this Contract, that it shall not be entitled to

compensation for other services rendered unless specifically authorized by the City by Resolution of its governing body. Contractor agrees that it has carefully examined the Scope of Services, and that the compensation is adequate for performance of this Contract.

14. WYOMING GOVERNMENTAL CLAIMS ACT:

The City does not waive any right or rights it may have pursuant to the Wyoming Governmental Claims Act, Wyoming Statutes Section 1-39-101 et seq., and the City specifically reserves the right to assert any and all rights, immunities, and defenses it may have pursuant to the Wyoming Governmental Claims Act.

15. NO THIRD PARTY BENEFICIARY RIGHTS:

The parties to this Contract do not intend to create in any other individual or entity the status of third-party beneficiary, and this Contract shall not be construed so as to create such status. The rights, duties and obligations contained in this Contract shall operate only between the parties to this Contract, and shall inure solely to the benefit of the parties to this Contract. The parties to this Contract intend and expressly agree that only parties signatory to this Contract shall have any legal or equitable right to seek to enforce this Contract, to seek any remedy arising out of a party's performance or failure to perform any term or condition of this Contract, or to bring an action for the breach of this Contract.

16. FORCE MAJEURE:

Neither party shall be liable for failure to perform under this Contract if such failure to perform arises out of causes beyond the control and without the fault or negligence of the nonperforming party. Such causes may include, but are not limited to, acts of God or the public enemy, fires, floods, epidemics, pandemics, quarantine restrictions, freight embargoes, and unusually severe weather. This provision shall become effective only if the party failing to perform immediately notifies the other party of the extent and nature of the problem, limits delay in performance to that required by the event, and takes all reasonable steps to minimize delays.

17. ELECTRONIC SIGNATURES:

The parties understand and agree that they have the right to execute this Contract through paper or through electronic signature technology, which is in compliance with Wyoming and federal law governing electronic signatures. The parties agree that to the extent they sign electronically, their electronic signature is the legally binding equivalent to their handwritten signature. Whenever they execute an electronic signature, it has the same validity and meaning as their handwritten signature. They will not, at any time in the future, repudiate the meaning of their electronic signature or claim that their electronic signature is not legally binding. They agree not to object to the admissibility of this Contract as an electronic record, or a paper copy of an electronic document, or a paper copy of a document bearing an electronic signature, on the grounds that it is an electronic record or electronic

signature or that it is not in its original form or is not an original. Each party will immediately request that their electronic signature be revoked in writing if they discover or suspect that it has been or is in danger of being lost, disclosed, compromised or subjected to unauthorized use in any way. If either party would like a paper copy of this Contract, they may request a copy from the other party, and the other party shall provide it.



BUILDING INTELLIGENCE

*Technology for
Better Buildings*

to:	Mark Harris	Sept. 16, 2022
company:	City of Casper	delivery terms: FOB Destination -012 DDP Seller (Incoterms 2010)
from:	Brian Dubois	payment terms: Net 60 days
regarding:	Proposal – Ford Wyoming Center – New Boiler Exhaust Venting Rev. 3	order acceptance:

Due to current world-wide raw material price instability, this proposal is valid for 45 days from date of issue. LONG reserves the right to adjust pricing as necessary after 45 days.

Thank you for considering a proposal from LONG Building Technologies, on installing new boiler exhaust venting at the Ford Wy Center. Please see the following pages for the problem description and recommendation with scope of work.

Material Price – Supply all new AL29C Stainless Steel Exhaust Venting.....\$96,909.

Please refer to the attached drawings for a detailed list of the material to be provided

Labor Price – Demo all existing boiler venting and install all new venting.....\$33,051.

Total.....\$129,960.

Please call or write if you have any questions or concerns about this proposal or scope of work. To authorize the work to proceed, please complete the customer acceptance section below or provide some other form of written approval.

Brian Dubois
Account Manager
LONG Building Technologies

Accepted _____
Signature

Name _____

Date _____

P O Number _____
New Boiler Exhaust Venting – Ford Wy Center

Problem:**BUILDING INTELLIGENCE**

The main vertical exhaust vent for all the boilers at the Events Center, is rusting badly on the outside layer of the metal jacketing and is leaking out acidic fluid on to the floor. This is a safety concern as this exhaust venting could also be leaking out dangerous carbon monoxide gases into the mechanical room. This exhaust venting is supposed to be air-tight.

The exhaust venting material on the inside of the vent is made of stainless steel. The outer jacket of the venting is made of galvanized steel. This outer galvanized steel layer is rusting and leaking fluid and possibly carbon monoxide gases. We believe what happened is that the interior stainless steel has become unsealed and both air and acidic fluid is leaking out of the opening. Then this acidic fluid hits the galvanized steel outer portion and rusts out the metal and leaks out.

The existing exhaust venting runs through the attic up to the roof, consequently it is very difficult to get to and very difficult to try to repair. We believe the best solution is to just replace all the existing exhaust venting. See below for the scope of work.

Scope of Work

Please see the drawing showing from the original boiler venting installation in 2010. We will be duplicating this boiler exhaust venting installation exactly. This drawing shows all the specific exhaust venting parts that will be used.

1. With the use of a crane service, pull out the entire main / vertical boiler exhaust vent out from the roof.
2. Remove all the remaining exhaust venting in the boiler room connecting to each boiler.
3. With the use of a crane service, supply and install a whole new "Schebler" AL29C stainless steel vertical exhaust vent. New vent will be dropped in from the roof.
4. Supply and install all new "Schebler" AL29C exhaust venting in the mechanical room connecting the above new vertical vent, to all the boilers in the mechanical room.
5. All existing boiler exhaust venting will be replaced with all new Schebler AL29C exhaust venting.
6. Provide start up and check out of the exhaust venting.



BUILDING ENVIRONMENTS

CASPER EVENT CENTER BOILER FLUE

8/15/2022

SECURITY CHIMNEY BOILER FLUE

TAG(S): FOR BOILER PLANT AT THE EVENT CENTER

SPECIFICATION SECTION: 23XXX

CONTRACTOR NOTES/INCLUDED OPTIONS:

- CONTRACTOR TO CONFIRM SIZES, QUANTITIES, MOUNTING STYLE
- SSD and SS PER ATTACHED SUBMITTAL AND DRAWING

E

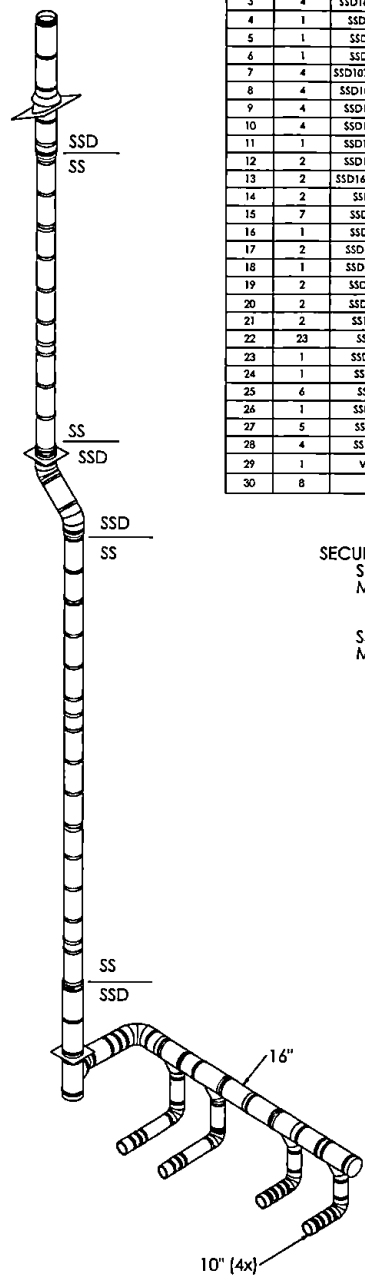
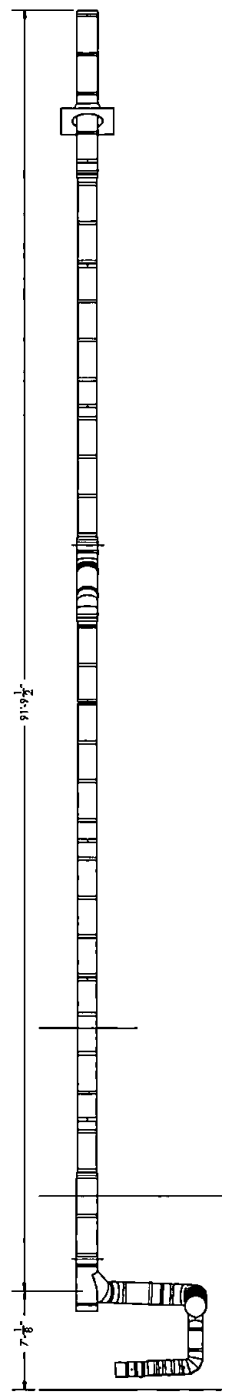
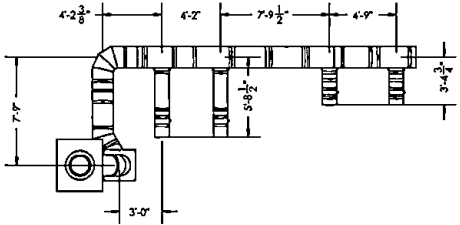
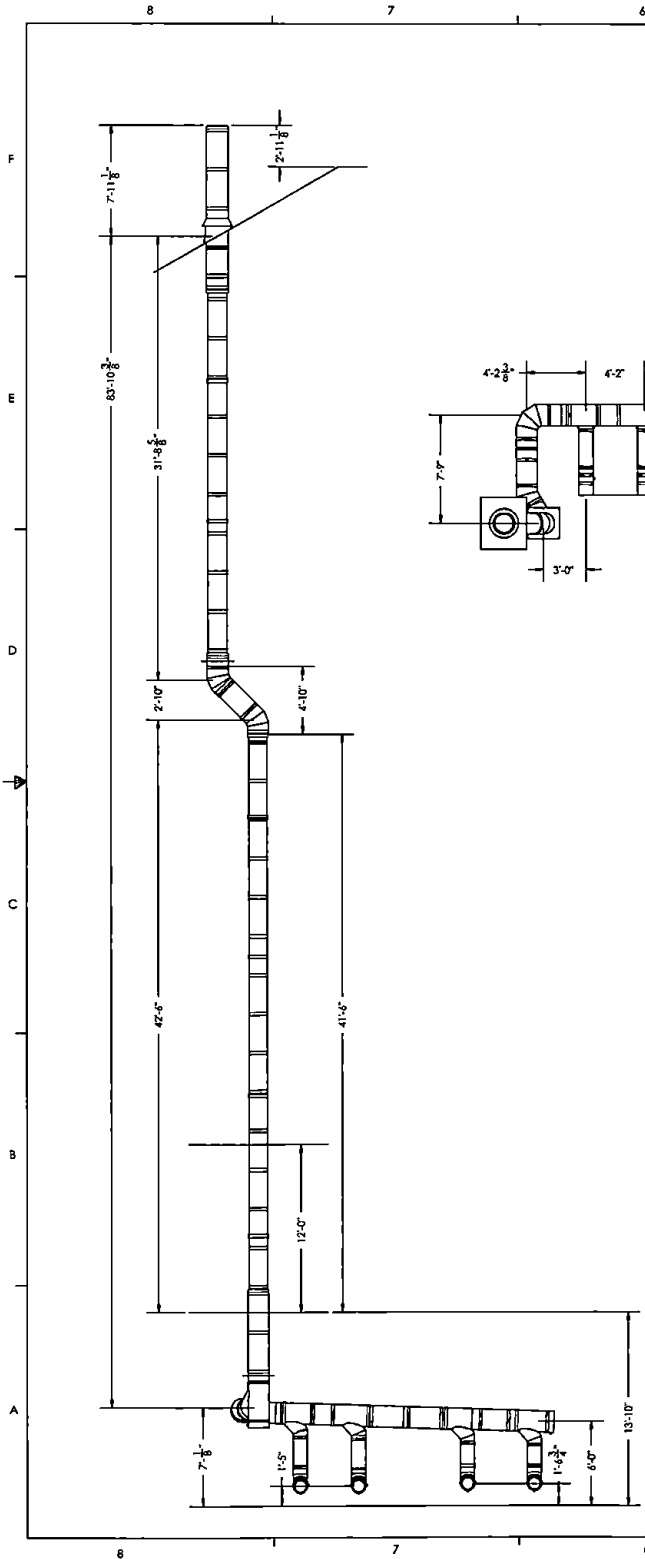

ITEM NO.	QTY	PART NUMBER	DESCRIPTION
1	4	SSD10UNBAOUK	10" Dia. Universal Exterior
2	4	SSD10EB8UK	10" Dia. 88° Elbow
3	4	SSD16BT8831OUK	16" Dia. 88° Lateral Tee w/ 10" Tap
4	1	SSD16BT88UK	16" Dia. 88° Lateral Tee
5	1	SSD16E90UK	16" Dia. 90° Elbow
6	1	SSD16E30UK	16" Dia. 30° Elbow
7	4	SSD10TPI1/2NPTUK	10" Dia. Test Port Length 1/2 NPT
8	4	SSD10DL1NPTUK	10" Dia. Drain Length 1 NPT
9	4	SSD10LAT32UK	10" Dia. 32" Telescopic Length
10	4	SSD16LAT32UK	16" Dia. 32" Telescopic Length
11	1	SSD16LAT20UK	16" Dia. 20" Telescopic Length
12	2	SSD10LAT20UK	10" Dia. 20" Telescopic Length
13	2	SSD14DTC1NPTUK	16" Dia. Drain Tee Cap 1 NPT
14	2	SSD10L9UK	10" Dia. 9" Length
15	7	SSD16L36UK	16" Dia. 36" Length
16	1	SSD14L12UK	16" Dia. 12" Length
17	2	SSD16AP1PUK	16" Dia. Length Anchor Plate
18	1	SSD16AL18UK	16" Dia. 4" to 14" Adjustable Length
19	2	SSD16SSAUK	16" Dia. SSD to SS Adapter
20	2	SSD16E45UK	16" Dia. 45° Elbow
21	2	SS16SSDAU	16" Dia. SS to SSD Adapter
22	23	SS16L36U	16" Dia. 36" Length
23	1	SSD16CTUK	16" Dia. Closer Termination
24	1	SSD16FAH	16" Dia. Adjustable Flashing
25	6	SS16GSH	16" Dia. Guy Support
26	1	SSD16GSH	16" Dia. Guy Support
27	5	SSD16SBH	16" Dia. Suspension Band
28	4	SSD10CSSH	10" Dia. Cradle Support
29	1	VITON-L	Viton Caulk
30	8	LUBE	O-Ring Gasket Lube

SECURE SEAL
 SSD (1" AIR GAP)
 MATERIAL:
 INNER WALL AL29-4C
 OUTER WALL 441
 SS (SINGLE WALL)
 MATERIAL. AL29-4C

SECURITY CHEMISTS INTERNATIONAL LIMITED (SICIL) WARRANTS THAT ITS PRODUCTS ARE MANUFACTURED IN ACCORDANCE WITH THE SPECIFICATIONS LISTED HEREIN. ANY EXCESSIVE CONDITIONS OR STORAGE CHANGES TO SICIL PROVIDED DOCUMENTS OR DRAWINGS MUST BE REPORTED TO THE SUBMITTER IMMEDIATELY. SICIL HAS RETURNED TO SICIL COVERING THE RETURN OF THE PRODUCTS. ALL DIMENSIONS AND MATERIALS LISTED IN THIS PRODUCT SPECIFICATION AND PRODUCT APPLICATION MANUAL ARE APPROVED BY THE COMPANY. IT IS THE RESPONSIBILITY OF THE USER TO OBTAIN A COPY OF THE DRAWINGS AND RETURNED TO SICIL. ANY PURCHASE ORDER RECEIVED WITHOUT A SIGNED AND DATED ORDER WILL BE CONSIDERED CONFIRMATION THAT ALL LISTED PRODUCT SPECIFICATIONS AND DIMENSIONS ARE FULLY APPROVED.

CONTRACTOR RESPONSIBLE FOR SECURING LUBRICANTS IN BUILDING. REFER TO THE APPLICABLE INSTRUCTIONS WHEN INSTALLING PRODUCT. ALL INSTRUCTIONS CAN BE FOUND ON OUR WEBSITE AT WWW.SICIL.COM

JOB NAME CASPER EVENT CENTER BOILER FLUE	PROJECT 215-1038
COMPANY LONG BUILDING	REVISION
	DRAWN BY MLH
	DATE 12/23/2021
	SHEET Sheet 1 of 1

PROJECT FOLDER



SUBMITTAL RECORD

Single Wall or Double Wall AL29-4C® or 316L.
 Special Gas Vent for Category I, II, III and IV.
 TYPE L VENT Low temperature venting system

3" to 24" Diameter Vent For use on Positive, Neutral and
 Negative Pressures up to 35" W.C.
 Also for venting listed gas or oil fired appliances listed for
 venting with TYPE L low temperature venting system
 (SSD / SSID ONLY)

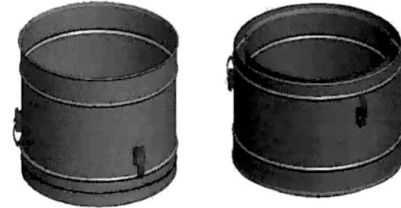

MODEL SS

MODEL SSD



MODEL SSID

MODEL Secure Seal® SS/SSD/SSID

	Listed to standards:
	UL-1738
	ULC-S636
	UL-641 } SSD / SSID ONLY
	ULC-S609 }
	Report # G100215896MTL-006

Reference to the installation instructions will enable you to obtain a safe, efficient and dependable installation of this vent system. Please read and understand these instructions before beginning your installation.

Do not alter or modify the components of this chimney system under any circumstances. Any modification or alteration of the vent system or approved accessories, including but not limited to the appliance it is connected to, may void the warranty, listings and approvals of this system and could result in an unsafe and potentially dangerous installation.

- A. Examine all components for possible shipping damage prior to installation;
- B. Proper joint assembly is essential for a safe installation. Follow these instructions exactly as written: Check severeness of joints upon completion of assembly;
- C. This venting system must be free to expand and contract. This venting system must be supported in accordance with these instructions;
- D. Check for unrestricted vent movement through walls, ceilings, and roof penetrations;
- E. Different manufacturers have different joint systems and adhesives. Do not mix pipe, fittings, or joining methods from different manufacturers.

SUBMITTAL RECORD	
PREPARED FOR: Sheet Metal Specialities	
REFERENCE: Casper Events Center-Boiler Flue	
LOCATION: Casper, Wyoming	
CONTACT: Scott Ross	
TELEPHONE: 307-472-4305	FAX:
EMAIL: Scott@smsi-wy.com	
PREPARED BY: David Corkill	

Material Selection
FLUE (INNER WALL)
AL29-4C
316L

TABLE OF CONTENTS

Introduction	page	2
Testing / listing information	page	2
Clearances to combustibles	page	3
General installation requirements	page	3
Typical installations	page	4-5
Chimney and fitting joint assembly	page	6
Chimney weight... ..	page	6
Support methods and height	page	7
Horizontal installation requirements	page	8
Maintain proper slope	page	9
Vertical installation requirements	page	9
Wall penetration	page	10
Roof / floor penetration	page	10
Condensate drains	page	10
Secure Seal as a liner	page	12
Adjustable length	page	13
Secure Seal Flex.....	page	14
Maintenance instructions... ..	page	15
Secure Seal Labels	page	16
Warranty	page	44
Product reference information.....	page	48

INTRODUCTION

Secure Seal® single wall (SS) or double wall (SSD) or double wall insulated (SSID) is a special stainless steel vent system for gas fired appliances listed as Category I, II, III, and IV or in Canada as Type BH Gas Venting as noted in ULC-636, with a maximum operating temperature of 550 Degrees F (288 Degrees C), and a maximum rated positive pressure of 35" Water Column. It can also vent listed gas or oil fired appliance rated to be vent with TYPE L low temperature venting system (SSD & SSID only). Secure Seal must be installed by an experienced professional familiar with the operation and maintenance of heating appliances and venting. Before installing this product, examine all components for possible shipping damage and read the complete installation manual. Failure to follow proper installation procedures, including vent pitch and improper appliance connections, may cause unsafe conditions. Security Chimneys International Limited recommends the system to be inspected once a year by a qualified service technician

TESTING / LISTING INFORMATION

Security Chimney International, Ltd. Secure Seal model SS, SSD and SSID venting system is listed with Intertek Testing Services (ETL) to UL/ULC standards:

U.S.A.

- UL-1738
Special Gas Vent for Category I, II, III and IV appliances
- UL-641 (SSD & SSID only)
TYPE L VENT venting listed gas or oil burning appliances



CANADA

- ULC-S636
Type BH Gas Vent Class I/II
- ULC-S609 (SSD & SSID only)
TYPE L VENT venting of flue gases with temperature not exceeding 300°C from oil or gas burning appliances

This product must be installed in accordance with local building code requirements as well as National codes: USA - National Fuel Gas code ANSI-Z223.1 or NFPA Standard 54, or NFPA 211. In CANADA - CAN/CGA-B149.1 or CAN/CGA-B149.2 Propane Installation Code as applicable.

CLEARANCES TO COMBUSTIBLES

Table 1 shows the required MINIMUM AIRSPACE CLEARANCE TO COMBUSTIBLES. "Combustibles" include framing lumber, drywall, plywood, paneling, insulation, wiring and other building materials.

Minimum Clearance to Combustibles Single Wall SS						
Diameter	Rated operating temperature	Max. operating temperature	Enclosed (4 sides)		Unenclosed (2 sides Max.)	
			Horiz.	Vert.	Horiz.	Vert.
3" to 12"	480° F (250° C)	550° F (288° C)	N/A	N/A	2"	2"
14" to 24"	480° F (250° C)	550° F (288° C)	N/A	N/A	4"	4"
Minimum Clearance to Combustibles Double Wall SSD / SSID						
Diameter	Rated operating temperature	Max. operating temperature	Enclosed (4 sides)		Unenclosed (2 sides Max.)	
			Horiz.	Vert.	Horiz.	Vert.
3" to 12"	480° F (250° C)	550° F (288° C)	N/A	1"	1"	1"
14" to 24"	480° F (250° C)	550° F (288° C)	N/A	1"	3"	1"
3" to 12" L-VENT	480° F (250° C)	550° F (288° C)	N/A	2"	2"	2"
14" to 24" L-VENT	480° F (250° C)	550° F (288° C)	N/A	2"	3"	2"

Table 1 - Minimum Clearances for Secure Seal®

Auxiliary parts such as combination Roof Supports, Roof Thimble, Flashings and Wall Thimble outer shields are intended to be attached directly to the framing or to ceilings, floors, or walls in accordance with their respective instructions. These parts, which are installed in contact with wood or other combustibles, are designed and tested to assure that they do not overheat at points of contact.

Notes:

- Unenclosed requires at least two sides open.
- Single Wall (SS) may be enclosed only in non-combustible enclosure.
- Reduced clearances may be attained by using non-combustible enclosures.
- Combustible Material is any material made of or surfaced with wood, compressed paper, plant fibers or other materials that are capable of being ignited or burned. Such material shall be considered combustible even though it is flame-proofed, fire-retardant treated, or plastered. (Source: NFPA 54/ANSI Z223.1)
- Design any enclosure to permit inspection of the system.
- Do not place insulation in any required clearance spaces surrounding the vent system unless these instructions suggest otherwise and the insulation is specified or supplied.
- When using Viton caulking, follow the manufactures required drying times.

Material Thickness

*all seams are laser welded

Secure Seal SS		Secure Seal SSD / SSID		
Diameter	Flue	Diameter	Flue	Casing
3" to 9"	AL29-4C - .015" 316L - .015"	3" to 9"	AL29-4C - .015" 316L - .015"	441 stainless - .015"
10" to 16"	AL29-4C - .020" 316L - .019"	10" to 16"	AL29-4C - .020" 316L - .019"	441 stainless - .020"
18" to 24"	AL29-4C - .024" 316L - .024"	18" to 24"	AL29-4C - .024" 316L - .024"	441 stainless - .024"

GENERAL INSTALLATION REQUIREMENTS

When venting Category I, II, III, or IV appliances or TYPE L vented appliance, Secure Seal **must** be used for the entire length of the system. Do not mix pipe, fittings, or joining methods from different manufacturers. **See the Secure Seal catalog for a complete list of parts and products.** Every vent system must be planned and installed for optimum performance and safety. The venting system must be free to expand and contract and must be supported in accordance with these instructions. (Check for unrestricted vent movement through walls, ceilings, and roof penetrations). Refer to the gas appliance manufacturer's instructions to determine venting requirements and limitations with respect to installation and use of the appliance. **It is the responsibility of the installer to contact local building and fire officials concerning any installation restrictions and/or inspection requirements that may apply.** Permits may be required before starting an installation.

- If required by the appliance manufacturer, a Drain Tee Cap must be located as close as possible to the appliance flue outlet. Depending on the arrangement of the vent, **more than one drain may be required.** Unless a Drain Tee Cap is supplied with the appliance, install a Secure Seal Drain Tee Cap.
- More than one Category II, III or IV appliance may not be connected into the same vent system, unless the appliance manufacturer specifically approved such a system and the appliance are designed for multiple venting. Cat. II, III or IV appliances MAY NOT be common vented with Cat. I, natural draft appliances. This limitation can be removed if an engineering analysis demonstrates normal and safe operation of appliances.
- Secure Seal must not come in contact with plumbing or electrical systems.
- Maintain rated clearances to combustibles over the entire length of the vent system.
- Secure Seal shall not be routed into, through, or within any vent, such as an existing masonry or factory-built chimney, that is **connected to another appliance.**

PART NUMBERS

These instructions identify major model SS-SSD-SSID parts by name and part number.

Material Code Designations	
B	Type 316 Stainless Steel
H	Type 430 Stainless Steel
K	Type 441 Stainless Steel
P	Type 439 Stainless Steel
U	Type AL29-4C Stainless Steel

Example:

SSD 36" length with inside diameter 14" made of AL29-4C inner flue and SS441 outer casting.

SSD	14	L36	UK
Model	Dia.	Part	Material

SS 30° elbow with inside diameter 22" made of 316L.

SS	22	E30	B
Model	Dia.	Part	Material

SSD wall support for 8" diameter chimney made of stainless 439.

SSD	8	WSHD	P
Model	Dia.	Part	Material

TYPICAL INSTALLATION

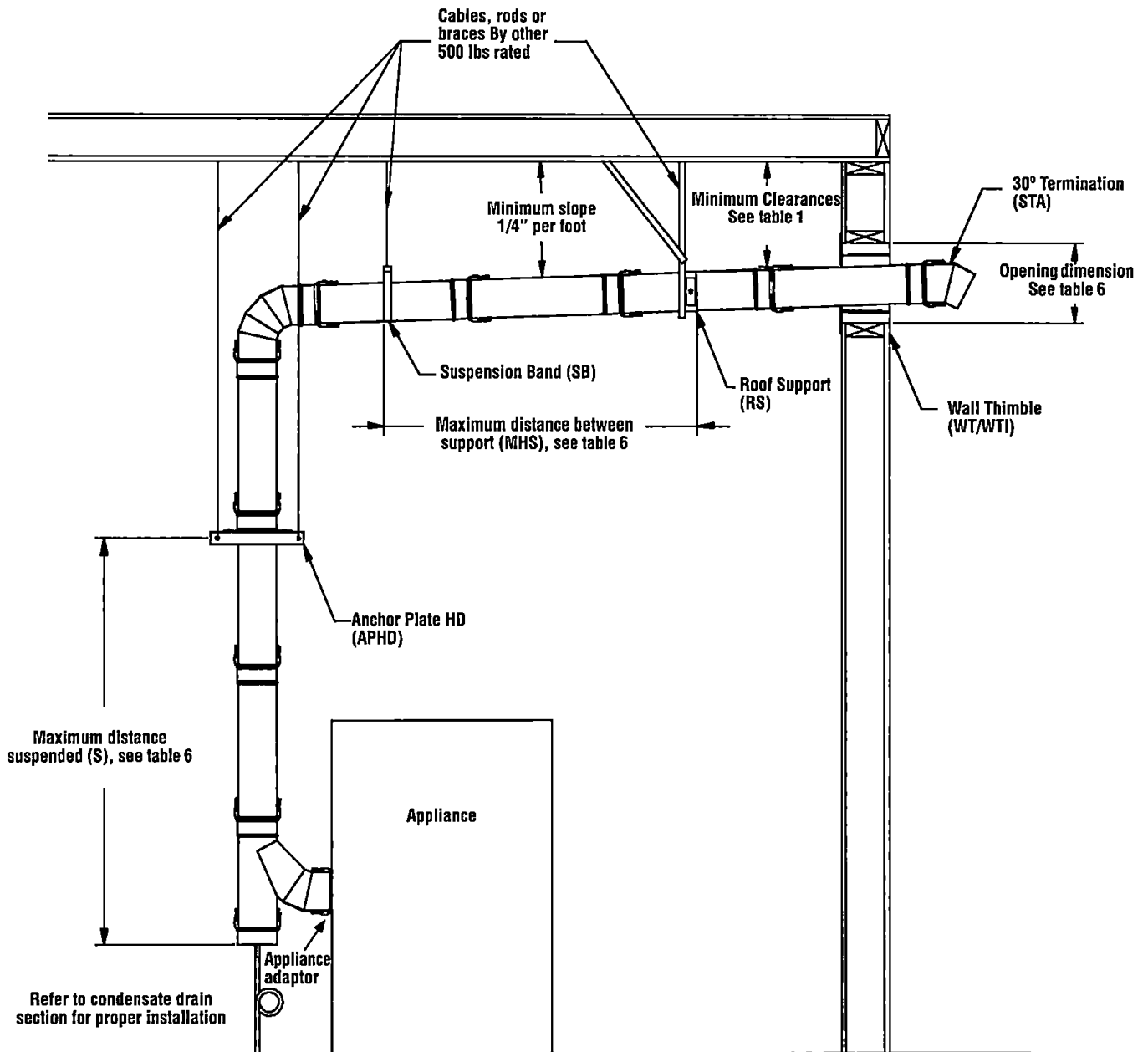

Figure 1 - Horizontal

TYPICAL INSTALLATION

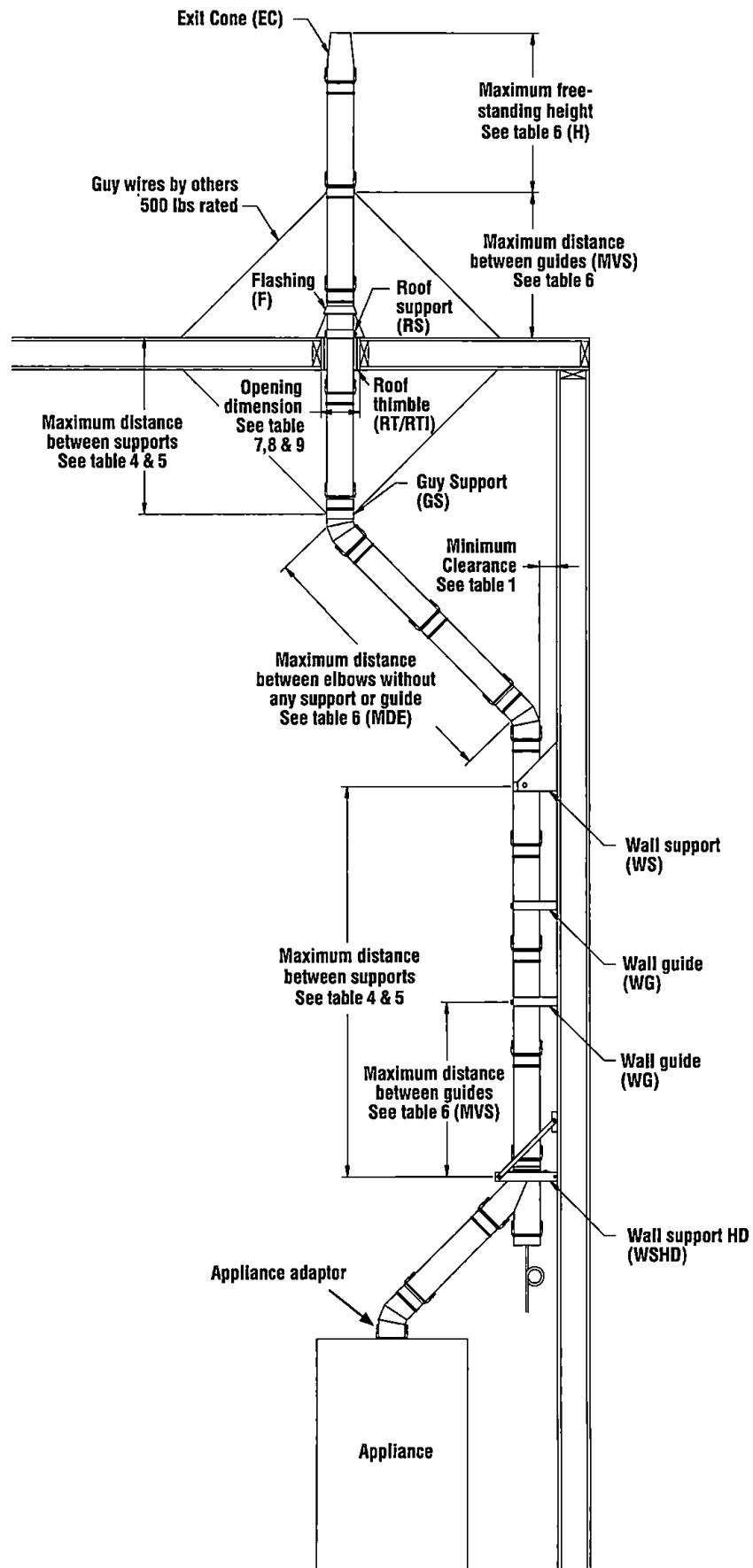
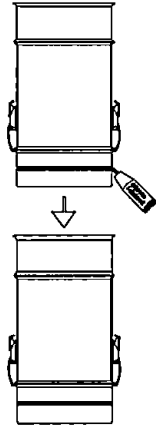

Figure 2 - Vertical

CHIMNEY AND FITTING JOINT ASSEMBLY

All components have a male and female end, the male end has the gasket. The installation orientation is indicated on the labeling of each chimney section with an arrow. The arrow indicated the direction of the flow.

Secure Seal® SS



1. Add a thin film of silicone lubricant on the o-ring.

2. Insert the male end into the female end.

Secure Seal SSD / SSID

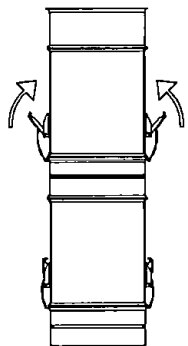
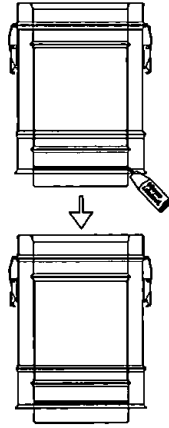

3. Close the clips to secure the joint.

NOTE:
Clips are self-locking

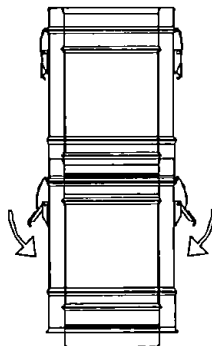

Figure 3 - Joint assembly steps

To open clips, push the secondary catch while pulling up the lever

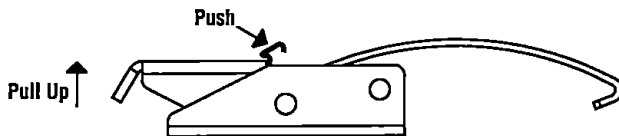

Figure 4 - Opening clips

ASSEMBLY JOINT SS/SSD/SSID LUBE REQUIREMENT	
Inside diameter	Qty (oz)
3"	0.1
4"	0.1
5"	0.1
6"	0.1
7"	0.1
8"	0.2
9"	0.2
10"	0.2
12"	0.3
14"	0.3
16"	0.3
18"	0.4
20"	0.4
22"	0.5
24"	0.5

Table 2

CHIMNEY WEIGHT

Chimney weight is given in pounds per foot of each diameter. It is important to know the weight of the chimney section for chimney support or guiding. Chimney weight (table 3) along with the maximum chimney height (table 4) is necessary to calculate the proper anchor strength needed with supports.

CHIMNEY WEIGHT IN LB/FT			
INSIDE DIAMETER	SS	SSD	SSID
3"	0.7	1.7	2.1
4"	0.9	2.1	2.6
5"	1.1	2.6	3.0
6"	1.3	3.0	3.4
7"	1.5	3.4	3.9
8"	1.7	3.8	4.3
9"	1.9	4.3	N/A
10"	2.1	4.7	5.5
12"	2.6	6.2	7.0
14"	3.6	7.7	8.2
16"	4.1	8.7	9.3
18"	4.6	9.8	10.3
20"	5.1	10.8	11.3
22"	5.7	11.8	12.4
24"	6.2	12.8	N/A

Table 3 - Chimney weight

Example: Model Secure Seal SSD 6" diameter section of 25 feet in length from table 3, weight in lb/ft = 3. Total length 3 x 25 = 75lbs.

SUPPORT METHODS AND HEIGHT

1. Several support and guiding methods are used to anchor a chimney against upward, downward and angular placement.
2. These supports and guides prevent bending stresses on the chimney elbows and joints.
3. Certain limitations apply for proper installation of supports and guides. See tables 4 and 5.
4. See figure 1 and 2 for typical installations.

MAXIMUM CHIMNEY HEIGHTS AND SUPPORT METHOD FOR MODEL SS							
Inside dia.	Anchor Plate (AP)	Anchor Plate HD (APHD)	Anchor Plate Length (APL)	Wall Support (WS)	Wall Support HD (WSHD)	Roof support (RS)	Guy support (GS)
3"	200	200	200	100	200	100	250
4"	200	200	200	100	200	100	250
5"	195	195	195	97.5	195	97.5	225
6"	190	190	190	95	190	95	190
7"	185	185	185	92.5	185	92.5	160
8"	180	180	180	90	180	90	140
9"	175	175	175	87.5	175	87.5	130
10"	170	170	170	85	170	85	115
12"	160	160	160	80	160	80	90
14"	150	150	150	75	150	75	65
16"	140	140	140	70	140	70	60
18"	130	130	130	65	130	65	55
20"	120	120	120	60	120	60	50
22"	110	110	110	55	110	55	45
24"	100	100	100	50	100	50	40

MAXIMUM CHIMNEY HEIGHTS AND SUPPORT METHOD FOR MODEL SSID							
Inside dia.	Anchor Plate (AP)	Anchor Plate HD (APHD)	Anchor Plate Length (APL)	Wall Support (WS)	Wall Support HD (WSHD)	Roof support (RS)	Guy support (GS)
3"	100	100	100	50	100	50	115
4"	100	100	100	50	100	50	115
5"	97.5	97.5	97.5	48.75	97.5	48.75	95
6"	95	95	95	47.5	95	47.5	80
7"	92.5	92.5	92.5	46.25	92.5	46.25	70
8"	90	90	90	45	90	45	65
9"	87.5	87.5	87.5	43.75	87.5	43.75	55
10"	85	85	85	42.5	85	42.5	50
12"	80	80	80	40	80	40	40
14"	75	75	75	37.5	75	37.5	30
16"	70	70	70	35	70	35	27
18"	65	65	65	32.5	65	32.5	25
20"	60	60	60	30	60	30	22
22"	55	55	55	27.5	55	27.5	21
24"	50	50	50	25	50	25	20

Table 4 - Dimensions are in feet

MAXIMUM CHIMNEY HEIGHTS AND SUPPORT METHOD FOR MODEL SSID							
Inside dia.	Anchor Plate (AP)	Anchor Plate HD (APHD)	Anchor Plate Length (APL)	Wall Support (WS)	Wall Support HD (WSHD)	Roof support (RS)	Guy support (GS)
3"	95	95	95	47.5	95	47.5	80
4"	95	95	95	47.5	95	47.5	80
5"	92.5	92.5	92.5	46.25	92.5	46.25	70
6"	90	90	90	45	90	45	65
7"	87.5	87.5	87.5	43.75	87.5	43.75	55
8"	85	85	85	42.5	85	42.5	50
9"	N/A	N/A	N/A	N/A	N/A	N/A	N/A
10"	80	85	85	42.5	85	42.5	40
12"	75	75	75	37.5	75	37.5	30
14"	70	70	70	35	70	35	27
16"	65	65	65	32.5	65	32.5	25
18"	60	60	60	30	60	30	22
20"	55	55	55	27.5	55	27.5	21
22"	50	50	50	25	50	25	20
24"	N/A	N/A	N/A	N/A	N/A	N/A	N/A

Table 5 - Dimensions are in feet

SUPPORT AND GUIDE SPACING FOR MODEL SS						
Inside diameter	MVS		MHS	MDE	H	S
	Interior	Exterior				
3"	10	8	12	12	10	50
4"	10	8	12	12	10	100
5"	10	8	12	12	10	100
6"	10	8	12	12	10	100
7"	10	8	12	12	10	100
8"	10	8	12	12	10	100
9"	10	8	12	12	10	100
10"	10	8	12	12	10	100
12"	10	8	12	12	10	100
14"	10	8	12	12	10	100
16"	10	8	12	12	10	100
18"	10	8	12	12	10	100
20"	10	8	12	12	10	100
22"	10	8	12	12	10	100
24"	10	8	12	12	10	100

SUPPORT AND GUIDE SPACING FOR MODEL SSD & SSID						
Inside diameter	MVS		MHS	MDE	H	S
	Interior	Exterior				
3"	10	8	12	12	10	50
4"	10	8	12	12	10	50
5"	10	8	12	12	10	50
6"	10	8	12	12	10	50
7"	10	8	12	12	10	50
8"	10	8	12	12	10	50
9"	10	8	12	12	10	50
10"	10	8	12	12	10	50
12"	10	8	12	12	10	50
14"	10	8	12	12	10	50
16"	10	8	12	12	10	50
18"	10	8	12	12	10	50
20"	10	8	12	12	10	50
22"	10	8	12	12	10	50
24"	10	8	12	12	10	50

Table 6 - Dimensions are in feet

MVS: Maximum Vertical Spacing between Guides/Supports
MHS: Maximum Horizontal Spacing between Guides/Supports
MDE: Maximum Distance between Elbows
H: Maximum Freestanding Height above the Roof
S: Maximum Suspended Length

***Important Notes:**

1. For Anchor Plate (AP) / Anchor Plate Heavy Duty (APHD) / Wall Support Heavy Duty (WSHD), the support must be installed below a bead. See figure 5.
2. For Wall Support (WS) / Roof Support (RS), the support can be installed anywhere on the part.
3. For Anchor plate length, the support is already integrated to a length. Directly attached to the building structure or supported by non combustible structural elements (not included). No other installation is required than the standard installation for a regular length.

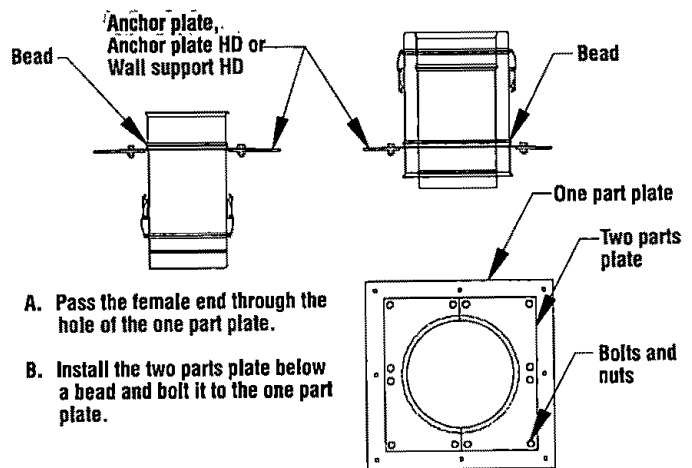

- A. Pass the female end through the hole of the one part plate.
- B. Install the two parts plate below a bead and bolt it to the one part plate.

Figure 5 - Position of support

HORIZONTAL INSTALLATION REQUIREMENTS

- When venting through a sidewall, terminate the system not less than 12" (.3m) above the ground and above the snow line in geographical areas where snow accumulates. The termination area must be kept clear of snow and ice at all times.
- Terminate the system at least 7' (2.1 m) above a public walkway or driveway, no less than 6' (1.8m) from the combustion air intake of any appliance or 3' (.9m) from any other building opening, gas utility meter, service regulator or the like. Less distance is permitted if specified in the appliance's installation instructions. It also shall terminate at least 3' (.9M) above any forced air inlet within 10' (3.1m) and shall terminate at least 4' (1.2m) below, 4' horizontally from, or 1' (.3m) above any door, window, or gravity air inlet into any building as provided in the National Fuel Gas Code ANSI Z223.1 and NFPA 54. See figure 6. Proper judgment may require greater distances depending on the side of the equipment installed or to allow for snow drifting or falling from falling from overhead roofs or trees. The termination should be far enough away from trees, shrubs, or decorative items to prevent damage.
- The total horizontal vent length from the appliance flue collar to the outside termination shall be in accordance with the appliance manufacturer's instructions.

MAINTAIN PROPER SLOPE

- Install with a continuous 1/4" per foot (minimum) slope, as is required by the National Fuel Gas Code for all gas-fired appliances.
- Vent systems for condensing appliances must have a continuous 1/4" per foot (minimum) slope toward the appliance or a condensate drain. Always check the appliance manufacturer's instructions for proper drain requirements.
- Secure Seal® offers a range of tees and elbows that are built incorporating a 2 degree slope, we recommend that you use these to generate your slope.
- Some appliances require the venting system to be sloped toward the horizontal termination.
- Remember, if you raise the appliance or lower the ceiling you must adjust the slope of the vent to maintain the 1/4" per foot minimum.

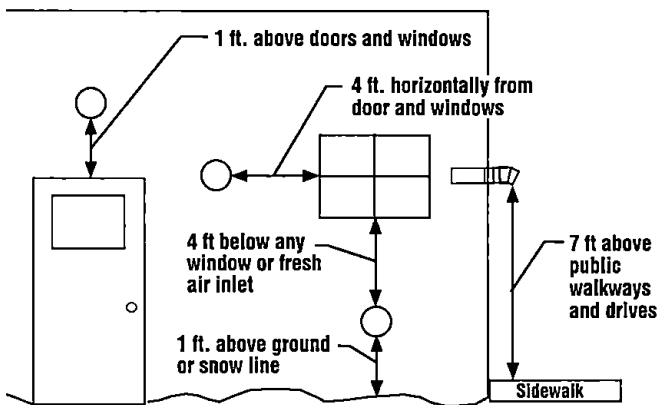

Figure 6 - Horizontal termination requirements

VERTICAL INSTALLATION REQUIREMENTS

- 1 The vent system must terminate at least 3 feet above the roof line and at least 2 feet higher than any portion of the building within 10 feet. See figure 7. This limitation can be removed if an engineering analysis demonstrates normal and safe operation of appliance.
2. When terminated at a height of more than 10 feet, the stack must be supported by a Guy Section.
3. The vent system must terminate with one of the Secure Seal® terminations.

Except;

- a) Category I appliances (natural draft) must use a Rain Cap. It is optional on Category II. This limitation can be removed if an engineering analysis demonstrates normal and safe operation of appliance.
 - b) Vent systems without provisions for draining rain water must use a Rain Cap.
 - c) Terminations or approved mechanical vent devices specified or provided by the appliance manufacturer are permitted.
4. The total continuous distance of the vent system from the appliance flue collar to the termination shall not exceed that specified in the appliance manufacturer's installation instructions. When venting natural draft appliances the termination must be at least 5 feet above the topmost draft hood. This limitation can be removed if an engineering analysis demonstrates normal and safe operation of appliance.
 5. In general, systems installed in cold climates perform best, and condensation is reduced, when the system is fully enclosed by some part of the building structure or by using insulated SSID venting system.
 6. In cold climates do not install a condensate drain on the exterior of the building. Doing so may result in dangerous icy conditions on surfaces near the drain and may cause damage to the vent system and/or the building exterior. Security Chimneys will NOT be held liable for any personal injury or property damage due to any formation of ice.
 7. Vertical supports are required after every transition to vertical. Vertical supports are also required after every offset elbow.
 8. Unless Secure Seal is installed in a fire rated shaft, a roof thimble and support is required when penetration fire rated floors, walls or ceilings.

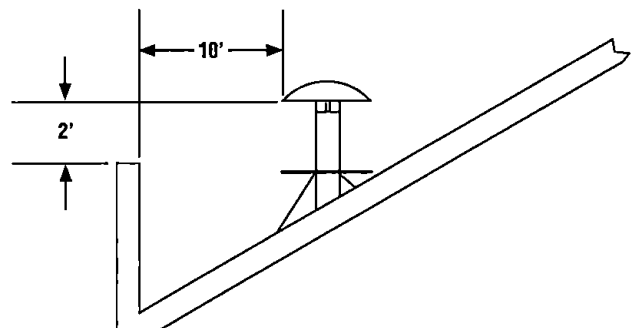

2 ft. above structures within 10 ft.

Figure 7 - Vertical installation requirements

WALL PENETRATION

1. Prior to installation, determine proper location of wall thimble (WT) or wall thimble insulated (WTI) so that a minimum slope of 1/4" (6mm) per foot is maintained in the horizontal section of vent to ensure proper flow of condensation.
2. Prepare the wall by cutting a square opening. See table 6 for opening dimension.
3. Install the wall thimble by inserting the larger of the two parts on the appliance (interior side). See figure 8.
4. Next, apply a bead of sealant around the edges of the exterior (smaller of the two parts) wall thimble component. Then install this part of the wall thimble by inserting the smaller collar into the other component from the previous step.

NOTE: The two horizontal cylinders of the thimble must engage a minimum of two inches.

5. Fasten both sides of the wall thimble using screws or nails.
6. Once the thimble is installed, Secure Seal® vent pipe can be inserted into the thimble.
7. Close the gap between the thimble and the vent by installing the two half plate and fasten it using screws or nails.
8. Install horizontal termination to complete the assembly.
9. Once assembly is completed, apply a bead of high-temp sealant around the pipe and the exterior two half plates of the thimble to protect against weather.
10. The air gap is filled with insulation when using the insulated wall thimble (WTI).

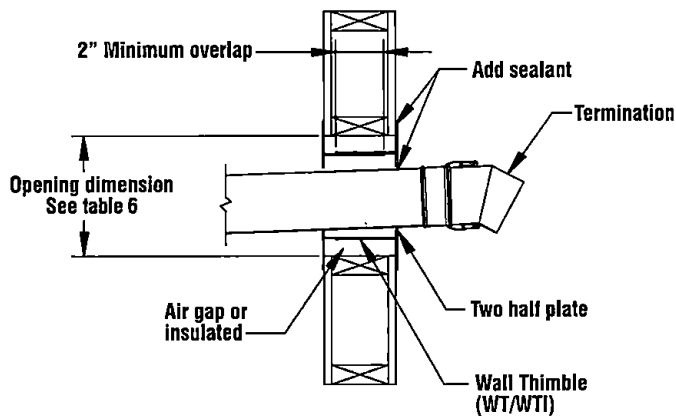

Figure 8 - Wall penetration

ROOF / FLOOR PENETRATION

1. A roof thimble (RT) or roof thimble insulated (RTI) for cold climate must be installed every time the vent system passes through a floor or roof.
2. Prepare the roof / floor by cutting a square opening. See table 6.
3. Install the roof thimble. You may cut the radiation sleeve if it is too long. See figure 9.
4. For roof installation, install a flashing.

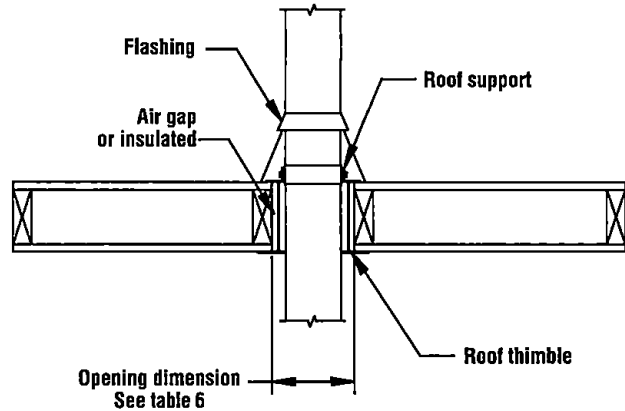

Figure 9 - Roof penetration

CONDENSATE DRAINS

When an internal condensate drain is NOT part of the appliance:

1. A Drain length (DL) or a Tee with a drain tee cap (DTC) is strongly recommended. Install this drain as close as possible to the appliance flue collar.
2. A condensate drain is required for every 30 feet of horizontal vent and at the bottom of a vertical stack.
3. Use the Drain length for a straight horizontal run. Rotate the fitting so that the drain tube is as vertical as possible.
4. Use a Tee at a transition from horizontal to vertical, and attach the Drain Tee Cap to the appropriate branch of the tee.
5. A condensate drain tube kit is available to direct the condensate to an appropriate location. A trap loop must be formed into the drain hose and must be a diameter that is at least four times the appliance's rated stack pressure in inches of water column or minimum 3 inches. Secure the loop with a cable tie.
6. Flue gas condensate can have a low (3 to 5) PH level, follow all local and national codes and regulations for the draining of acidic condensate.
7. In cold climate, do not install a condensate drain on the exterior of the building. Doing so may result in dangerous icy conditions on surfaces near the drain and may cause damage to the vent system and the building exterior. Security Chimneys™ will NOT be held liable for any injury or property damage due to formation of ice.

OPENING DIMENSIONS FOR WALL/ROOF PENETRATION FOR MODEL SS				
Inside diameter	Wall Thimble (WT)	Wall Thimble Insulated (WTI)	Roof Thimble (RT)	Roof Thimble Insulated (RTI)
3"	8x8	9x9	7x7	11x11
4"	9x9	10x10	8x8	12x12
5"	10x10	11x11	9x9	13x13
6"	11x11	12x12	10x10	14x14
7"	12x12	13x13	11x11	15x15
8"	13x13	14x14	12x12	16x16
9"	14x14	15x15	13x13	17x17
10"	15x15	16x16	14x14	18x18
12"	17x17	18x18	16x16	20x20
14"	22x22	22x22	22x22	22x22
16"	24x24	24x24	24x24	24x24
18"	26x26	26x26	26x26	26x26
20"	28x28	28x28	28x28	28x28
22"	30x30	30x30	30x30	30x30
24"	32x32	32x32	32x32	32x32

Table 7 - Dimensions are in inches

OPENING DIMENSIONS FOR WALL/ROOF PENETRATION FOR MODEL SSD				
Inside diameter	Wall Thimble (WT)	Wall Thimble Insulated (WTI)	Roof Thimble (RT)	Roof Thimble Insulated (RTI)
3"	10x10	11x11	7x7	11x11
4"	13x13	14x14	10x10	14x14
5"	14x14	15x15	11x11	15x15
6"	15x15	16x16	12x12	16x16
7"	16x16	17x17	13x13	17x17
8"	17x17	18x18	14x14	18x18
9"	N/A	N/A	N/A	N/A
10"	19x19	20x20	16x16	20x20
12"	22x22	22x22	18x18	22x22
14"	24x24	24x24	20x20	24x24
16"	26x26	26x26	22x22	26x26
18"	28x28	28x28	24x24	28x28
20"	30x30	30x30	26x26	30x30
22"	32x32	32x32	28x28	32x32
24"	N/A	N/A	N/A	N/A

Table 9 - Dimensions are in inches

OPENING DIMENSIONS FOR WALL/ROOF PENETRATION FOR MODEL SSD				
Inside diameter	Wall Thimble (WT)	Wall Thimble Insulated (WTI)	Roof Thimble (RT)	Roof Thimble Insulated (RTI)
3"	12x12	13x13	9x9	13x13
4"	11x11	12x12	8x8	12x12
5"	12x12	13x13	9x9	13x13
6"	13x13	14x14	10x10	14x14
7"	14x14	15x15	11x11	15x15
8"	15x15	16x16	12x12	16x16
9"	16x16	17x17	13x13	17x17
10"	17x17	18x18	14x14	18x18
12"	19x19	20x20	16x16	20x20
14"	22x22	22x22	18x18	22x22
16"	24x24	24x24	20x20	24x24
18"	26x26	26x26	22x22	26x26
20"	28x28	28x28	24x24	28x28
22"	30x30	30x30	26x26	30x30
24"	32x32	32x32	28x28	32x32

Table 8 - Dimensions are in inches

INSTALLING SECURE SEAL® AS A LINER IN A MASONRY CHIMNEY OR AS A LINER IN AN EXISTING VENT

* Stainless Steel Wire Rope (by others) is to be used to hang the vent system from the top of the masonry chimney or from the top of the existing vent.

- The stainless wire rope is attached to the Guy Support Band and is secured with cable clamps (by others).
- The Stainless Steel Wire Rope is secured in a similar manner to the top platform of the masonry chimney or existing vent.
- Use the appropriate size of Stainless Steel Wire Rope to accommodate the required total loads of the vent system.

It may be necessary to fabricate a platform (at top of chimney / vent - by others).

Consult Security Chimneys International for guidelines.

DO NOT USE GALVANIZED WIRE ROPE.

Note: When installed as a liner in a masonry chimney or to reline an existing vent no other appliance can be vented into the same chimney or vent.

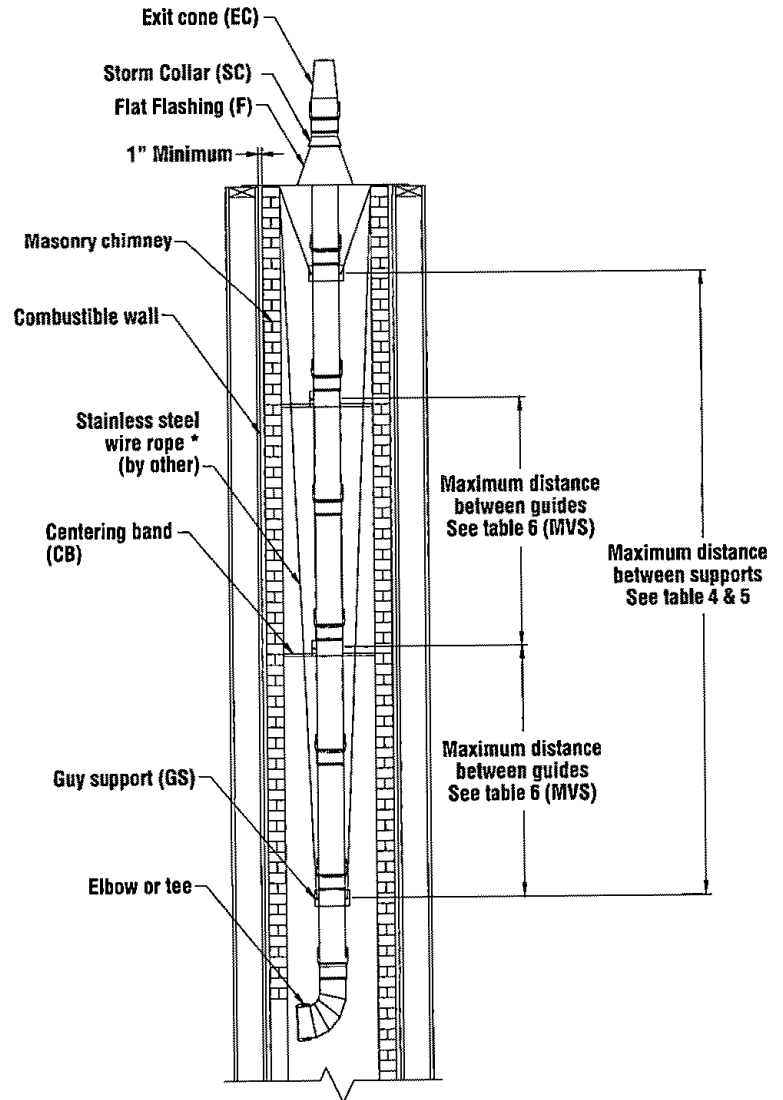

Figure 10 - Installing Secure Seal as a liner

ADJUSTABLE LENGTH

For installations that requires non-standard vent lengths, Secure Seal® Adjustable Length (AL) should be used.

The part consists of an inner conduit that slips into the downstream part and over the upstream part, a collar holds the conduit in place and an outer shell (for double wall only). See figure 11 for installation steps.

Note: The inner conduit may be cut to desired length to limit interference with downstream part.

ADJUSTABLE LENGTH SS/SSD CAULKING REQUIREMENT	
Inside diameter	Qty (oz)
3"	0.2
4"	0.3
5"	0.4
6"	0.5
7"	0.6
8"	0.7
9"	0.8
10"	0.9
12"	1.0
14"	1.2
16"	1.4
18"	1.5
20"	1.7
22"	1.9
24"	2.1

Table 10

Secure Seal SS

1. Keep a play about 1/8" to 1/4" to allow thermal expansion
2. Apply a 1/8" to 1/4" bead (may vary) of Viton caulking to fill the gap between the adjustable length inner wall and the female end of the standard part. Please allow 24-36 hours for Viton to cure."

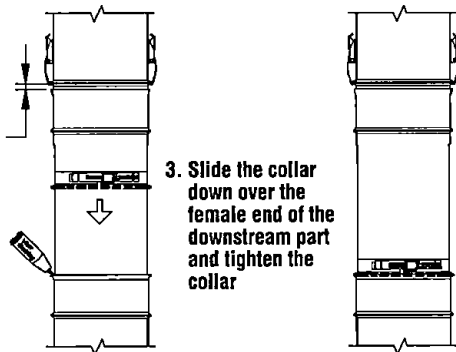

3. Slide the collar down over the female end of the downstream part and tighten the collar

Secure Seal SSD

1. Keep a play about 1/8" to 1/4" to allow thermal expansion
2. Apply a 1/8" to 1/4" bead (may vary) of Viton caulking to fill the gap between the adjustable length inner wall and the female end of the standard part. Please allow 24-36 hours for Viton to cure.

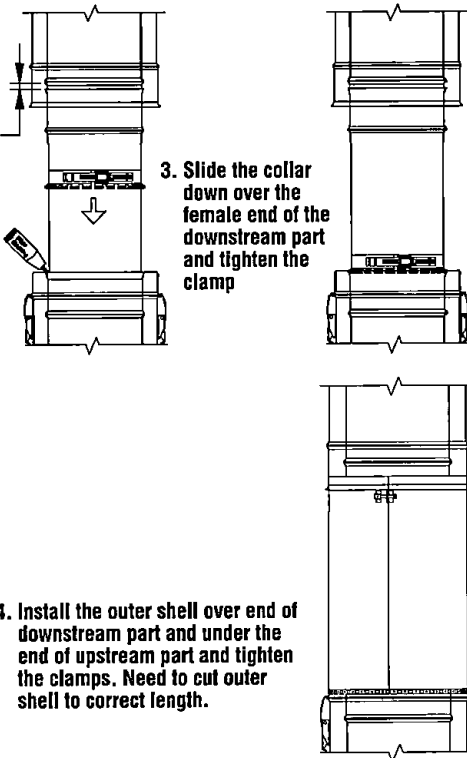

4. Install the outer shell over end of downstream part and under the end of upstream part and tighten the clamps. Need to cut outer shell to correct length.

Figure 11 - Adjustable length installation steps

SECURE SEAL FLEX

***IMPORTANT NOTE**

When installing Secure Seal Flex, the direction of exhaust flow is always from the appliance. There is an arrow printed on each section of liner and component that will point in the direction of the exhaust gas. If the inner liner is installed correctly the proper direction can be determined by running your fingernails up the inside wall of the liner. If the direction is correct, your nails will catch at the seams of the inner wall. If it is incorrect, your nails will slide smoothly across the inner surface.

Attaching adapters to SECURE SEAL FLEX liner

- 1- The adapter without the latches is the Female Flex Adapter and designed for the top of the flex liner. The Adapter with the latches and the black Viton O-ring is the Male Flex Adapter and is designed for the bottom of the flex liner. If cutting the liner on the field is required, make sure the cut is square.
- 2- Make a mark on both ends of liner at 1 5/8" from each end. (Figure 12a) That mark will act as a reference point when the adapters are fully seated onto the flex liner. (Figure 12b)
- 3- To be sure everything is right before putting the sealant between both tubes, do a dry fit test by pushing the liner into the adapter until it reach the bottom between the inner tube and the outer tube, then remove it. (Figure 13)
- 4- Add the sealant S-650 in the channel of the Male Flex Adapter. Put enough sealant so the channel gap is evenly covered all around. (Figure 14)
- 5- Push the adapter on the liner (the inner tube fits inside the liner and the outer tube fits outside the liner) all the way in. (Figure 15)
- 6- Push the little natches. (Figure 16)
- 7- Repeat steps 3 through 6 for the other end with the female flex adapter or the flex to flex adapter
- 8- Before installation, cure for a minimum of 24 hours or follow the cure time called out by the silicone manufacturer.

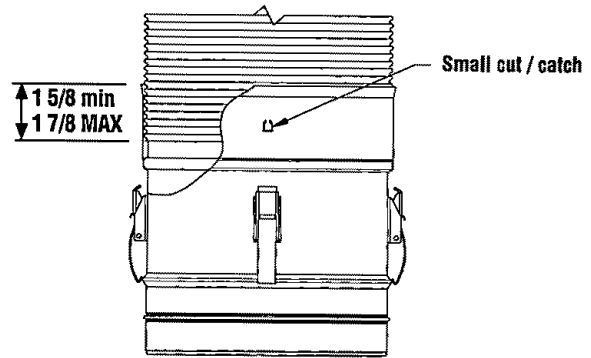

Figure 12b - Flex Adapter small cut / catch

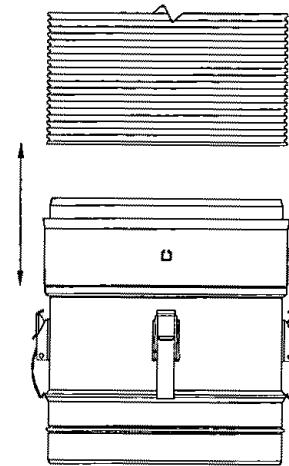

Figure 13 - Flex Adapter dry fit test

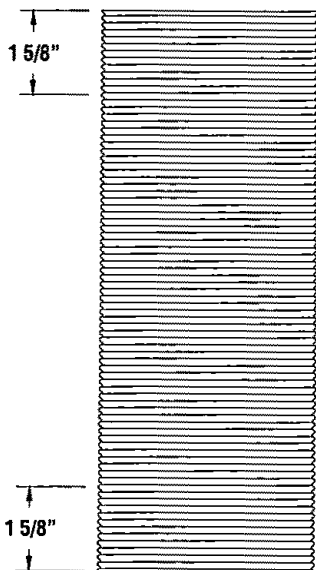

Figure 12a - Secure Seal Flex liner

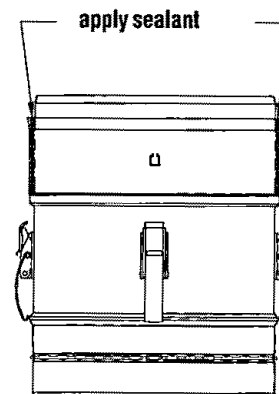

Figure 14 - Flex Adapter apply sealant

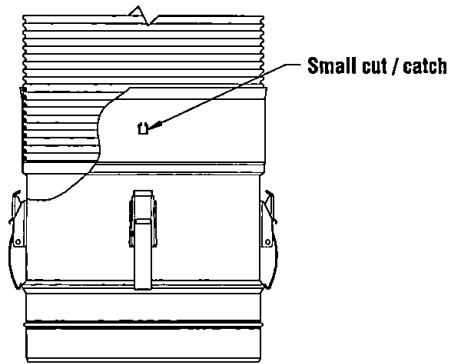

Figure 15 - Flex Adapter, seating flex

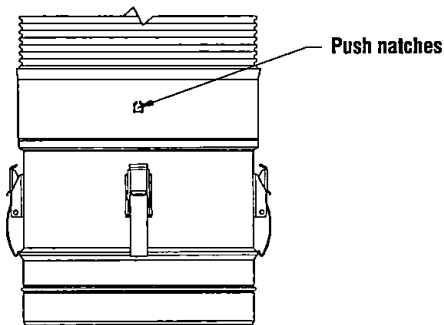

Figure 16 - Flex Adapter push notch to lock

BASIC SECURE SEAL FLEX LINER INSTALLATION

- 1- Determine the required location and opening in the masonry chimney. For a basic Secure Seal Flex installation the opening must be large enough for the mortar sleeve and Male Flex Adapter and the Secure Seal Flex to easily pass through. If a Tee application is necessary, a larger hole may be required.
- 2- Make sure the Secure Seal Flex is supported at the bottom of the chimney. Refer to Figure 10 for guiding and support installation in the masonry chimney.
- 3- The Secure Seal Flex liner must be installed from the top of the masonry chimney. To prevent damage, one person should feed the liner through the chimney and another person should pull the liner from the bottom. To ease the installation, you can attach a rope to the Secure Seal Flex liner above the Male Flex Adapter. Doing this will reduce the chance of breaking the seal between the Secure Seal Flex and the Male Flex Adapter.
- 4- The Secure Seal Flex must stay within the masonry chimney; however the Elbow or other Secure Seal components will extend beyond the masonry chimney. (Figure 16)
- 5- It is strongly recommended to use a drain between the Male Flex Adapter and the appliance (refer to Condensate Drains section).

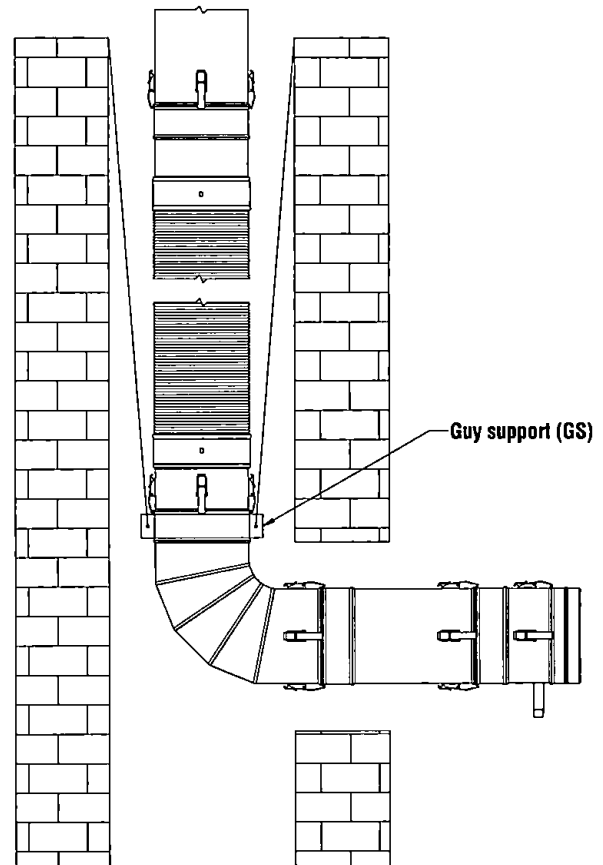

Figure 17 - Secure Flex Adapter Elbow in masonry

MAINTENANCE INSTRUCTIONS

As with all vents, the Secure Seal vent system should be inspected at least annually for the presence of deposits or debris and any accumulation should be removed. The vent system should also be inspected at regular periods for signs of leakage of condensate or combustion products at any joints.

If the vent system incorporates a drain hose from either a Drain length or a Drain tee cap, the hose must be inspected periodically to ensure that water is in the trap loop. If a proper trap loop is not maintained, exhaust from the connected appliances may accumulate in the building area.

SS, SSD / SSID SECURE SEAL® CHIMNEY LABELS

The labels supplied for product identification are shown here and indicates the flow of the flue gases in the venting system.

SPECIAL GAS VENT FOR CATEGORY I, II, III, IV AND TYPE BH CLASS I, II
 CONDUIT D'ÉVACUATION POUR CATÉGORIE I, II, III, IV ET TYPE BH CLASS I, II
AL29-4C
TYPE L LOW-TEMPERATURE OIL OR GAS VENTING SYSTEM (SSD/SSID ONLY)
 MAX TEMP 550°F / 288°C OR 570°F/300°C (L-VENT)
 Ø3" TO Ø24" / Ø3" À Ø24"
 FOR INTERIOR AND EXTERIOR USE
 RATED FOR USE AT MAXIMUM 35 INCH WATER COLUMN INTERNAL PRESSURE
 WHEN USED IN POSITIVE PRESSURE APPLICATION
 CLASSE POUR UNE UTILISATION A PRESSION POSITIVE INTERNE MAXIMALE DE 35 POUCHES DE COLONNE D'EAU

LISTED/HOMOLOGUÉ
UL-1738
ULC-S636
UL-641 (SSD/SSID)
ULC-S609 (SSD/SSID)



Intertek
4002244

WARNING
 RISK OF CARBON MONOXIDE (CO) POISONING AND RISK OF FIRE IF
 IMPROPERLY INSTALLED. FOLLOW ALL CAUTIONS, WARNINGS AND
 INSTRUCTIONS REGARDING INSTALLATION OF VENT PIPE SYSTEM.
AVERTISSEMENT
 RISQUE D'EMPOISONNEMENT AU MONOXIDE DE CARBONE (CO) SI MAL INSTALLÉ.
 LIRE ATTENTIVEMENT LES INSTRUCTIONS D'INSTALLATION FOURNIES AVEC CE PRODUIT.

MODEL Secure Seal® SS / SSD / SSID

MINIMUM CLEARANCE TO COMBUSTIBLE - SINGLE WALL SS							
DÉGAGEMENT MINIMAL AUX MATÉRIAUX COMBUSTIBLES - PAROI SIMPLE SS							
Dia.	Rated Operating Temperature	Maximum Temperature	Enclosed / Fermé (4 sides/côtés)		Unenclosed / Ouvert (2 sides/côtés)		
			Horizontal	Vertical	Horizontal	Vertical	
			3" - 12"	480°F (249°C)	550°F (288°C)	N/A	N/A
14" - 24"	480°F (249°C)	550°F (288°C)	N/A	N/A	4"	4"	
MINIMUM CLEARANCE TO COMBUSTIBLE - DOUBLE WALL SSD / SSID							
DÉGAGEMENT MINIMAL AUX MATÉRIAUX COMBUSTIBLES - PAROI DOUBLE SSD / SSID							
Dia.	Rated Operating Temperature	Maximum Temperature	Enclosed / Fermé (4 sides/côtés)		Unenclosed / Ouvert (2 sides/côtés)		
			Horizontal	Vertical	Horizontal	Vertical	
			3" - 12"	480°F (249°C)	550°F (288°C)	N/A	1"
14" - 24"	480°F (249°C)	550°F (288°C)	N/A	1"	3"	1"	
3" - 12" (L-Vent)	480°F (249°C)	550°F (288°C)	N/A	2"	2"	2"	
14" - 24" (L-Vent)	480°F (249°C)	550°F (288°C)	N/A	2"	3"	2"	

UP HAUT
FLOW DIRECTION ÉCOULEMENT



SECURITY CHIMNEYS INTERNATIONAL



LAVAL, QC CANADA NP314 REV.8

SPECIAL GAS VENT FOR
 CATEGORY I, II, III, IV
 AND TYPE BH CLASS I, II
 CONDUIT D'ÉVACUATION POUR
 CATÉGORIE I, II, III, IV
 ET TYPE BH CLASS I, II
 TYPE L (SSD/SSID)

LISTED/HOMOLOGUÉ
UL-1738
ULC-S636
UL-641 (SSD/SSID)
ULC-S609 (SSD/SSID)



Intertek
4002244

MODEL Secure Seal® SS/SSD/SSID
Accessories / Accessoires



SECURITY CHIMNEYS INTERNATIONAL



LAVAL, QC, CANADA NP315 REV.5

SSD / SSID VENT LENGTHS

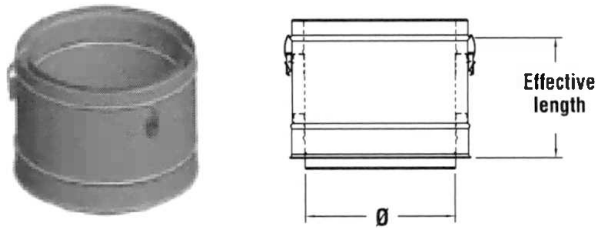

SSD & SSID Lengths			
Ø (in.)	Effective Length (in.)	Product Code SSD	Product Code SSID
3 to 24	6-5/8	SSDØL9	SSIDØL9
3 to 24	9-5/8	SSDØL12	SSIDØL12
3 to 24	15-5/8	SSDØL18	SSIDØL18
3 to 24	21-5/8	SSDØL24	SSIDØL24
3 to 24	33-5/8	SSDØL36	SSIDØL36

NOTE: SSID 9" and 24" not available.

Figure 18

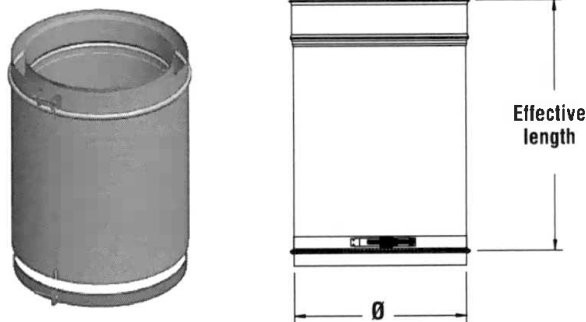

SSD & SSID Adjustable Lengths			
Ø (in.)	Effective Length (in.)	Product Code SSD	Product Code SSID
3 to 24	3 to 5	SSDØAL9	SSIDØAL9
3 to 24	3 to 14	SSDØAL18	SSIDØAL18

NOTE: SSID 9" and 24" not available

Figure 19

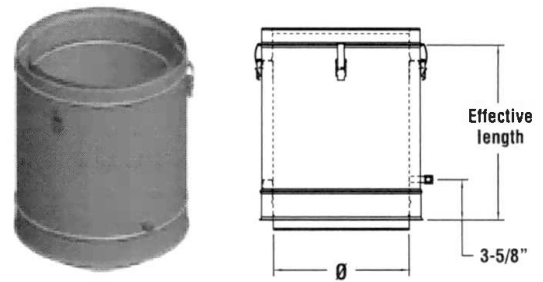

SSD & SSID Test Port Lengths			
Ø (in.)	Effective Length (in.)	Product Code SSD	Product Code SSID
3 to 24	6-5/8	SSDØTPL	SSIDØTPL

Drain Ø4-Ø24, 1/4 NPT, 1/2 O.D.

NOTE: SSID 9" and 24" not available.

Figure 20

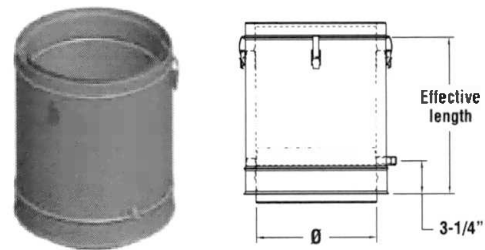

SSD & SSID Drain Lengths				
Ø (in.)	Effective Length (in.)	Product Code SSD	Product Code SSID	K Factor
3 to 24	6-5/8	SSDØDL	SSIDØDL	0.25

Drain Ø4-Ø10, 1/4 NPT, 1/2 O.D.
Drain 12-Ø24, 1/2 NPT, 5/8 O.D.

NOTE: SSID 9" and 24" not available

Figure 21

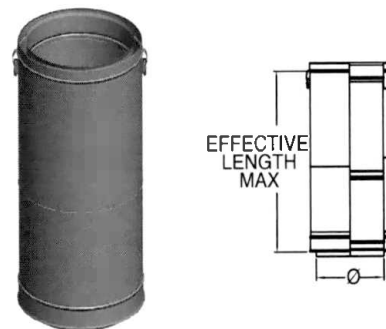

SSD Telescopic Lengths		
Ø (in.)	Effective Length (in.)	Product Code
3 to 24	14 to 20	SSDØLAT20
3 to 24	20 to 32	SSDØLAT32

NOTE: SSID 3", 9" and 24" not available.

Figure 21a

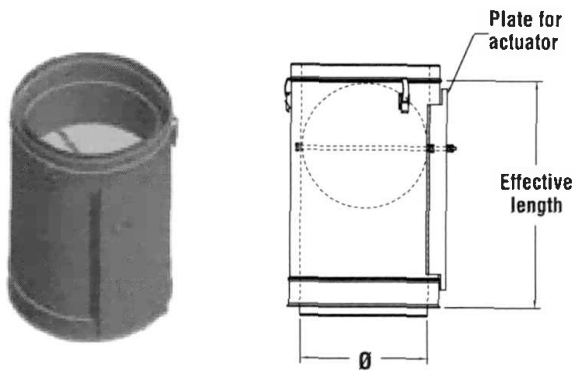

SSD & SSID Damper Lengths				
Ø (in.)	Effective Length (in.)	Product Code SSD	Product Code SSID	K Factor
3 to 24	15-5/8	SSDØDAMP	SSIDØDAMP	0.60-9999

Figure 22 NOTE: SSID 9" and 24" not available

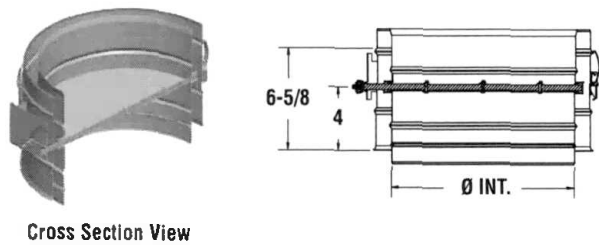

Cross Section View

SSD & SSID Damper Length Short Manual				
Ø (in.)	Effective Length (in.)	Product Code SSD	Product Code SSID	K Factor
3 to 24	6-5/8	SSDØDAMPS	SSIDØDAMPS	0 to 9999

Figure 23 NOTE: SSID 9" and 24" not available.

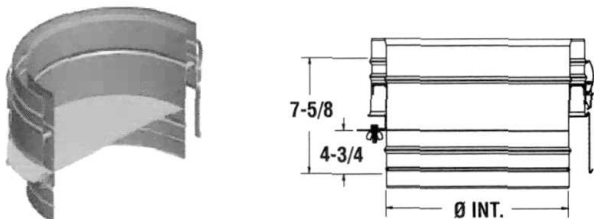

Cross Section View

SSD & SSID Vent Flow Regulator				
Ø (in.)	Effective Length (in.)	Product Code SSD	Product Code SSID	K Factor
3 to 24	5-7/8	SSDØVFR	SSIDØVFR	0 to 9999

Figure 24 NOTE: SSID 9" and 24" not available.

SSD & SSID VENTING ELBOWS

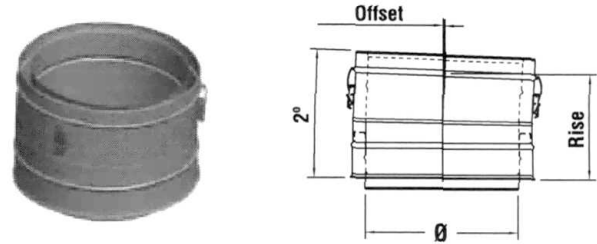

SSD 2-Degree Elbow				
Ø (in.)	Offset (in.)	Rise (in.)	Product Code SSD	K Factor
3	1/8	7-3/4	SSD3E2	.04
4	1/8	7-3/4	SSD4E2	.04
5	1/8	7-3/4	SSD5E2	.04
6	1/8	7-7/8	SSD6E2	.04
7	1/8	7-7/8	SSD7E2	.04
8	1/8	7-7/8	SSD8E2	.04
9	1/8	8	SSD9E2	.04
10	1/8	8	SSD10E2	.04
12	1/8	8	SSD12E2	.04
14	1/8	8-1/8	SSD14E2	.03
16	1/8	8-1/4	SSD16E2	.03
18	1/8	8-1/4	SSD18E2	.03
20	1/8	8-3/8	SSD20E2	.03
22	1/8	8-3/8	SSD22E2	.03
24	1/8	8-1/2	SSD24E2	.03

Figure 25

SSID 2-Degree Elbow				
Ø (in.)	Offset (in.)	Rise (in.)	Product Code SSID	K Factor
3	1/8	7-3/4	SSID3E2	.04
4	1/8	7-3/4	SSID4E2	.04
5	1/8	7-3/4	SSID5E2	.04
6	1/8	7-7/8	SSID6E2	.04
7	1/8	7-7/8	SSID7E2	.04
8	1/8	7-7/8	SSID8E2	.04
9	N/A	N/A	N/A	N/A
10	1/8	8	SSID10E2	.04
12	1/8	8	SSID12E2	.04
14	1/8	8-1/8	SSID14E2	.03
16	1/8	8-1/4	SSID16E2	.03
18	1/8	8-1/4	SSID18E2	.03
20	1/8	8-3/8	SSID20E2	.03
22	1-3/4	8-3/8	SSID22E2	.03
24	N/A	N/A	N/A	N/A

Figure 26 NOTE: SSID 9" and 24" not available

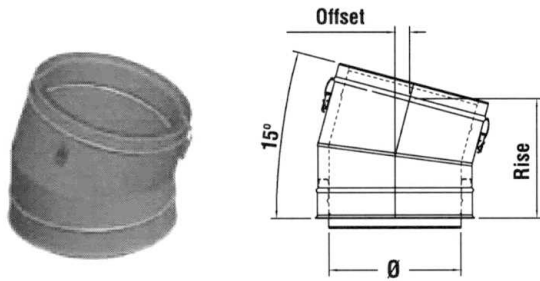

SSD 15-Degree Elbow				
Ø (in.)	Offset (in.)	Rise (in.)	Product Code SSD	K Factor
3	1	8-3/4	SSD3E15	.31
4	1	8-3/4	SSD4E15	.31
5	1	8-3/4	SSD5E15	.30
6	1-1/8	9	SSD6E15	.30
7	1-1/8	9-3/8	SSD7E15	.29
8	1-1/4	9-5/8	SSD8E15	.29
9	1-1/4	9-7/8	SSD9E15	.28
10	1-1/4	10-1/8	SSD10E15	.28
12	1-3/8	10-5/8	SSD12E15	.27
14	1-3/8	11-1/8	SSD14E15	.27
16	1-1/2	11-5/8	SSD16E15	.26
18	1-1/2	12-1/8	SSD18E15	.26
20	1-5/8	12-5/8	SSD20E15	.26
22	1-5/8	13-1/4	SSD22E15	.26
24	1-3/4	13-3/4	SSD24E15UK	.26

Figure 27

SSID 15-Degree Elbow				
Ø (in.)	Offset (in.)	Rise (in.)	Product Code SSID	K Factor
3	1-1/8	9	SSID3E15UK	.31
4	1-1/8	9	SSID4E15UK	.31
5	1-1/8	9-3/8	SSID5E15UK	.30
6	1-1/4	9-5/8	SSID6E15UK	.30
7	1-1/4	9-7/8	SSID7E15UK	.29
8	1-1/4	10-1/8	SSID8E15UK	.29
9	N/A	N/A	N/A	N/A
10	1-3/8	10-5/8	SSID10E15UK	.28
12	1-3/8	11-1/8	SSID12E15UK	.27
14	1-1/2	11-5/8	SSID14E15UK	.27
16	1-1/2	12-1/8	SSID16E15UK	.26
18	1-5/8	12-5/8	SSID18E15UK	.26
20	1-5/8	13-1/4	SSID20E15UK	.26
22	1-3/4	13-3/4	SSID22E15UK	.26
24	N/A	N/A	N/A	N/A

Figure 28

NOTE: SSID 9" and 24" not available.

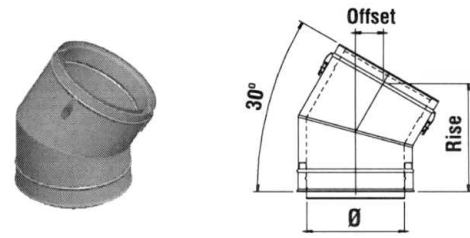

SSD 30-Degree Elbow				
Ø (in.)	Offset (in.)	Rise (in.)	Product Code SSD	K Factor
3	2-3/8	9-5/8	SSD3E30	.61
4	2-3/8	9-5/8	SSD4E30	.61
5	2-3/8	9-5/8	SSD5E30	.60
6	2-5/8	10-1/8	SSD6E30	.59
7	2-3/4	10-5/8	SSD7E30	.58
8	2-7/8	11-1/8	SSD8E30	.57
9	3	11-5/8	SSD9E30	.56
10	3-1/8	12-1/8	SSD10E30	.55
12	3-3/8	13-1/8	SSD12E30	.54
14	3-5/8	14-1/8	SSD14E30	.54
16	3-7/8	15-1/8	SSD16E30	.53
18	4-1/8	16-1/8	SSD18E30	.52
20	4-1/2	17-1/8	SSD20E30	.52
22	4-3/4	18-1/8	SSD22E30	.51
24	5	19-1/8	SSD24E30UK	.51

Figure 29

SSID 30-Degree Elbow				
Ø (in.)	Offset (in.)	Rise (in.)	Product Code SSID	K Factor
3	2-5/8	10-1/8	SSID3E30UK	0.61
4	2-5/8	10-1/8	SSID4E30UK	0.61
5	2-3/4	10-5/8	SSID5E30UK	0.60
6	2-7/8	11-1/8	SSID6E30UK	0.59
7	3	11-5/8	SSID7E30UK	0.58
8	3-1/8	12-1/8	SSID8E30UK	0.57
9	N/A	N/A	N/A	N/A
10	3-3/8	13-1/8	SSID10E30UK	0.55
12	3-5/8	14-1/8	SSID12E30UK	0.54
14	3-7/8	15-1/8	SSID14E30UK	0.54
16	4-1/8	16-1/8	SSID16E30UK	0.53
18	4-1/2	17-1/8	SSID18E30UK	0.52
20	4-3/4	18-1/8	SSID20E30UK	0.52
22	5	19-1/8	SSID22E30UK	0.51
24	N/A	N/A	N/A	N/A

Figure 30

NOTE: SSID 9" and 24" not available.

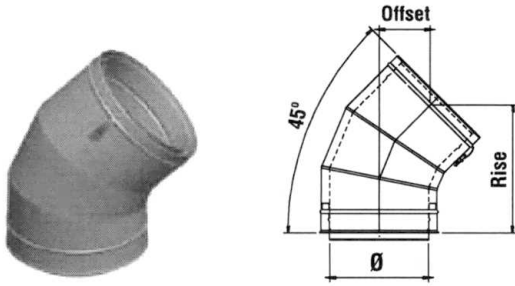

SSD 45-Degree Elbow				
Ø (in.)	Offset (in.)	Rise (in.)	Product Code SSD	K Factor
3	3-7/8	10-1/8	SSD3E45	.26
4	3-7/8	10-1/8	SSD4E45	.26
5	3-7/8	10-1/8	SSD5E45	.22
6	4-1/4	10-7/8	SSD6E45	.17
7	4-1/2	11-1/2	SSD7E45	.16
8	4-7/8	12-1/4	SSD8E45	.14
9	5-1/8	13	SSD9E45	.13
10	5-3/8	13-5/8	SSD10E45	.12
12	6	15-1/8	SSD12E45	.11
14	6-5/8	16-1/2	SSD14E45	.11
16	7-1/8	17-7/8	SSD16E45	.10
18	7-3/4	19-3/8	SSD18E45	.09
20	8-3/8	20-3/4	SSD20E45	.08
22	8-7/8	22-1/8	SSD22E45	.08
24	9-1/2	23-5/8	SSD24E45	.08

Figure 31

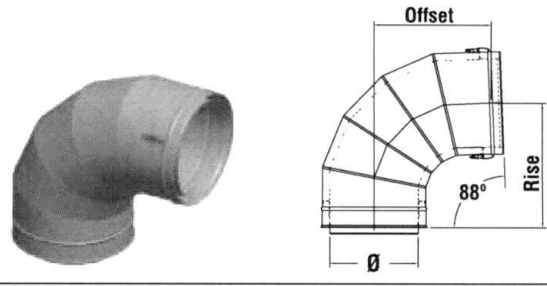

SSD 88-Degree Elbow				
Ø (in.)	Offset (in.)	Rise (in.)	Product Code SSD	K Factor
3	8-3/8	9-1/4	SSD3E88	.54
4	8-3/8	9-1/4	SSD4E88	.54
5	8-3/8	9-1/4	SSD5E88	.48
6	9-1/4	10-1/4	SSD6E88	.42
7	10-1/4	11-1/4	SSD7E88	.39
8	11-1/4	12-1/4	SSD8E88	.37
9	12-1/4	13-1/4	SSD9E88	.34
10	13-1/8	14-1/4	SSD10E88	.32
12	15-1/8	16-1/4	SSD12E88	.29
14	17	18-1/4	SSD14E88	.27
16	19	20-1/4	SSD16E88	.25
18	20-7/8	22-1/4	SSD18E88	.24
20	22-7/8	24-1/4	SSD20E88	.23
22	24-3/4	26-1/4	SSD22E88	.21
24	26-5/8	28-1/4	SSD24E88	.20

Figure 33

SSID 45-Degree Elbow				
Ø (in.)	Offset (in.)	Rise (in.)	Product Code SSID	K Factor
3	4-1/4	10-7/8	SSID3E45	0.26
4	4-1/4	10-7/8	SSID4E45	0.26
5	4-1/2	11-1/2	SSID5E45	0.22
6	4-7/8	12-1/4	SSID6E45	0.17
7	5-1/8	13	SSID7E45	0.16
8	5-3/8	13-5/8	SSID8E45	0.14
9	N/A	N/A	N/A	N/A
10	6	15-1/8	SSID10E45	0.12
12	6-5/8	16-1/2	SSID12E45	0.11
14	7-1/8	17-7/8	SSID14E45	0.11
16	7-3/4	19-3/8	SSID16E45	0.1
18	8-3/8	20-3/4	SSID18E45	0.09
20	8-7/8	22-1/8	SSID20E45	0.08
22	9-1/2	23-5/8	SSID22E45	0.08
24	N/A	N/A	N/A	N/A

Figure 32

NOTE: SSID 9" and 24" not available

SSID 88-Degree Elbow				
Ø (in.)	Offset (in.)	Rise (in.)	Product Code SSID	K Factor
3	9-1/4	10-1/4	SSID3E88	0.54
4	9-1/4	10-1/4	SSID4E88	0.54
5	10-1/4	11-1/4	SSID5E88	0.48
6	11-1/4	12-1/4	SSID6E88	0.42
7	12-1/4	13-1/4	SSID7E88	0.39
8	13-1/8	14-1/4	SSID8E88	0.37
9	N/A	N/A	N/A	N/A
10	15-1/8	16-1/4	SSID10E88	0.32
12	17	18-1/4	SSID12E88	0.29
14	19	20-1/4	SSID14E88	0.27
16	20-7/8	22-1/4	SSID16E88	0.25
18	22-7/8	24-1/4	SSID18E88	0.24
20	24-3/4	26-1/4	SSID20E88	0.23
22	26-5/8	28-1/4	SSID22E88	0.21
24	N/A	N/A	N/A	N/A

Figure 34

NOTE: SSID 9" and 24" not available.

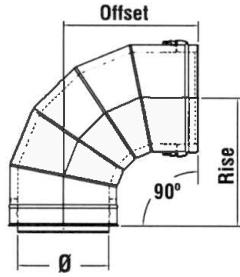

SSD 90-Degree Elbow				
Ø (in.)	Offset (in.)	Rise (in.)	Product Code SSD	K Factor
3	8-1/2	9-1/8	SSD3E90	.54
4	8-1/2	9-1/8	SSD4E90	.54
5	8-1/2	9-1/8	SSD5E90	.48
6	9-1/2	10-1/8	SSD6E90	.42
7	10-1/2	11-1/8	SSD7E90	.39
8	11-1/2	12-1/8	SSD8E90	.37
9	12-1/2	13-1/8	SSD9E90	.34
10	13-1/2	14-1/8	SSD10E90	.32
12	15-1/2	16-1/8	SSD12E90	.29
14	17-1/2	18-1/8	SSD14E90	.27
16	19-1/2	20-1/8	SSD16E90	.25
18	21-1/2	22-1/8	SSD18E90	.24
20	23-1/2	24-1/8	SSD20E90	.23
22	25-1/2	26-1/8	SSD22E90	.21
24	27-1/2	28-1/8	SSD24E90	.20

Figure 35

SSID 90-Degree Elbow				
Ø (in.)	Offset (in.)	Rise (in.)	Product Code SSID	K Factor
3	9-1/2	10-1/8	SSID3E90	.54
4	9-1/2	10-1/8	SSID4E90	.54
5	10-1/2	11-1/8	SSID5E90	.48
6	11-1/2	12-1/8	SSID6E90	.42
7	12-1/2	13-1/8	SSID7E90	.39
8	13-1/2	14-1/8	SSID8E90	.37
9	N/A	N/A	N/A	N/A
10	15-1/2	16-1/8	SSID10E90	.32
12	17-1/2	18-1/8	SSID12E90	.29
14	19-1/2	20-1/8	SSID14E90	.27
16	21-1/2	22-1/8	SSID16E90	.25
18	23-1/2	24-1/8	SSID18E90	.24
20	25-1/2	26-1/8	SSID20E90	.23
22	27-1/2	28-1/8	SSID22E90	.21
24	N/A	N/A	N/A	N/A

Figure 36 NOTE: SSID 9" and 24" not available

SSD & SSID VENTING TEES

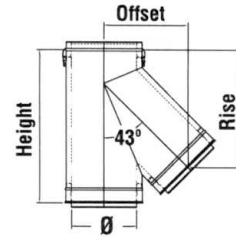

SSD 43-Degree Tee					
Ø (in.)	Height (in.)	Offset (in.)	Rise (in.)	Product Code	K Factor
3	16-1/2	8-1/4	13-3/8	SSD3T43	0.4
4	16-1/2	8-1/4	13-3/8	SSD4T43	0.4
5	18-1/2	8-7/8	14-3/8	SSD5T43	0.4
6	19-1/2	9-5/8	15-3/8	SSD6T43	0.4
7	20-1/2	10-1/4	16-1/4	SSD7T43	0.4
8	22-1/2	11-5/8	18	SSD8T43	0.4
9	23-1/2	12-1/4	18-7/8	SSD9T43	0.4
10	25-1/2	13	19-3/4	SSD10T43	0.4
12	28-1/2	15	22-3/8	SSD12T43	0.4
14	31-1/2	16-3/8	24-1/4	SSD14T43	0.4
16	33-1/2	18-1/2	26-1/4	SSD16T43	0.4
18	38-1/4	20-1/2	29-3/8	SSD18T43	0.4
20	42-1/4	23-7/8	33-1/2	SSD20T43	0.4
22	45-1/4	23-7/8	33-7/8	SSD22T43	0.4
24	51-1/4	27-7/8	38-1/2	SSD24T43	0.4

Available with smaller snout and custom height.

Figure 37

SSID 43-Degree Tee					
Ø (in.)	Height (in.)	Offset (in.)	Rise (in.)	Product Code	K Factor
3	19-1/2	9-5/8	15-3/8	SSID3T43	0.4
4	19-1/2	9-5/8	15-3/8	SSID4T43	0.4
5	20-1/2	10-1/4	16-1/4	SSID5T43	0.4
6	22-1/2	11-5/8	18	SSID6T43	0.4
7	23-1/2	12-1/4	18-7/8	SSID7T43	0.4
8	25-1/2	13	19-3/4	SSID8T43	0.4
9	N/A	N/A	N/A	N/A	N/A
10	28-1/2	15	22-3/8	SSID10T43	0.4
12	31-1/2	16-3/8	24-1/4	SSID12T43	0.4
14	33-1/2	18-1/2	26-1/4	SSID14T43	0.4
16	38-1/4	20-1/2	29-3/8	SSID16T43	0.4
18	42-1/4	23-7/8	33-1/2	SSID18T43	0.4
20	45-1/4	23-7/8	33-7/8	SSID20T43	0.4
22	51-1/4	27-7/8	38-1/2	SSID22T43	0.4
24	N/A	N/A	N/A	N/A	N/A

Available with smaller snout and custom height.

Figure 38 NOTE: SSID 9" and 24" not available

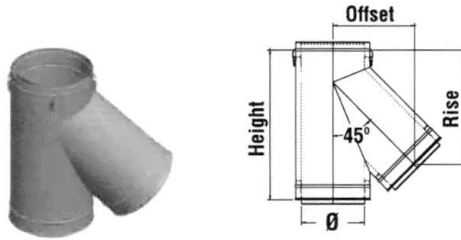

SSD 45-Degree Tee					
Ø (in.)	Height (in.)	Offset (in.)	Rise (in.)	Product Code	K Factor
3	16-1/2	8-1/4	13-1/4	SSD3T45	.04
4	16-1/2	8-1/4	13-1/4	SSD4T45	.04
5	18-1/2	9-1/4	14-1/8	SSD5T45	.04
6	19-1/2	9-7/8	15-1/8	SSD6T45	.04
7	20-1/2	10-5/8	16	SSD7T45	.04
8	22-1/2	12	17-5/8	SSD8T45	.04
9	23-1/2	12-3/4	18-1/2	SSD9T45	.04
10	25-1/2	13-1/2	19-1/2	SSD10T45	.04
12	28-1/2	15-5/8	22	SSD12T45	.04
14	31-1/2	17	23-7/8	SSD14T45	.04
16	33-1/2	19-1/8	26-3/8	SSD16T45	.04
18	38-1/4	21-1/4	28-7/8	SSD18T45	.04
20	42-1/4	24-3/4	32-7/8	SSD20T45	.04
22	45-1/4	24-3/4	33-1/4	SSD22T45	.04
24	51-1/4	28-7/8	37-3/4	SSD24T45	.04

Available with smaller snout and custom height.

Figure 39

SSID 45-Degree Tee					
Ø (in.)	Height (in.)	Offset (in.)	Rise (in.)	Product Code	K Factor
3	19-1/2	9-7/8	15-1/8	SSID3T45	.04
4	19-1/2	9-7/8	15-1/8	SSID4T45	.04
5	20-1/2	10-5/8	16	SSID5T45	.04
6	22-1/2	12	17-5/8	SSID6T45	.04
7	23-1/2	12-3/4	18-1/2	SSID7T45	.04
8	25-1/2	13-1/2	19-1/2	SSID8T45	.04
9	N/A	N/A	N/A	N/A	N/A
10	28-1/2	15-5/8	22	SSID10T45	.04
12	31-1/2	17	23-7/8	SSID12T45	.04
14	33-1/2	19-1/8	26-3/8	SSID14T45	.04
16	38-1/4	21-1/4	28-7/8	SSID16T45	.04
18	42-1/4	24-3/4	32-7/8	SSID18T45	.04
20	45-1/4	24-3/4	33-1/4	SSID20T45	.04
22	51-1/4	28-7/8	37-3/4	SSID22T45	.04
24	N/A	N/A	N/A	N/A	N/A

Available with smaller snout and custom height.

Figure 40 NOTE: SSID 9" and 24" not available

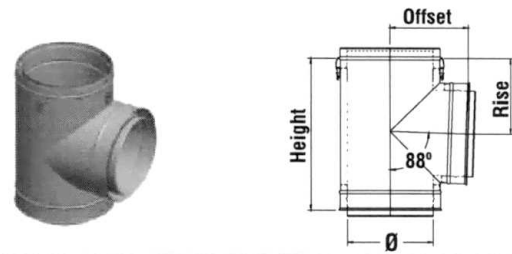

SSD 88-Degree Tee					
Ø (in.)	Height (in.)	Offset (in.)	Rise (in.)	Product Code	K Factor
3	13-1/2	7	6-5/8	SSD3T88	1.21
4	13-1/2	7	6-5/8	SSD4T88	1.21
5	14-1/2	8	7-1/4	SSD5T88	1.21
6	15-1/2	8	7-5/8	SSD6T88	1.21
7	16-1/2	9	8-1/4	SSD7T88	1.21
8	17-1/2	9	8-5/8	SSD8T88	1.21
9	18-1/2	10	9-1/4	SSD9T88	1.21
10	19-1/2	10	9-5/8	SSD10T88	1.21
12	21-1/2	11	10-5/8	SSD12T88	1.21
14	23-1/2	12	11-5/8	SSD14T88	1.21
16	25-1/2	13	12-5/8	SSD16T88	1.21
18	27-1/2	14	13-5/8	SSD18T88	1.21
20	29-1/2	15	14-5/8	SSD20T88	1.21
22	31-1/2	16	15-5/8	SSD22T88	1.21
24	33-1/2	17	16-5/8	SSD24T88	1.21

Available with smaller snout and custom height.

Figure 41

SSID 88-Degree Tee					
Ø (in.)	Height (in.)	Offset (in.)	Rise (in.)	Product Code	K Factor
3	15-1/2	8	7-5/8	SSID3T88	1.21
4	15-1/2	8	7-5/8	SSID4T88	1.21
5	16-1/2	9	8-1/4	SSID5T88	1.21
6	17-1/2	9	8-5/8	SSID6T88	1.21
7	18-1/2	10	9-1/4	SSID7T88	1.21
8	19-1/2	10	9-5/8	SSID8T88	1.21
9	N/A	N/A	N/A	N/A	N/A
10	21-1/2	11	10-5/8	SSID10T88	1.21
12	23-1/2	12	11-5/8	SSID12T88	1.21
14	25-1/2	13	12-5/8	SSID14T88	1.21
16	27-1/2	14	13-5/8	SSID16T88	1.21
18	29-1/2	15	14-5/8	SSID18T88	1.21
20	31-1/2	16	15-5/8	SSID20T88	1.21
22	33-1/2	17	16-5/8	SSID22T88	1.21
24	N/A	N/A	N/A	N/A	N/A

Available with smaller snout and custom height.

Figure 42 NOTE: SSID 9" and 24" not available.

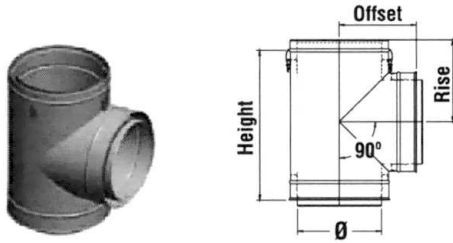

SSD 90-Degree Tee					
Ø (in.)	Height (in.)	Offset (in.)	Rise (in.)	Product Code	K Factor
3	13-1/2	7	6-1/2	SSD3T90	1.21
4	13-1/2	7	6-1/2	SSD4T90	1.21
5	14-1/2	8	7	SSD5T90	1.21
6	15-1/2	8	7-1/2	SSD6T90	1.21
7	16-1/2	9	8	SSD7T90	1.21
8	17-1/2	9	8-1/2	SSD8T90	1.21
9	18-1/2	10	9	SSD9T90	1.21
10	19-1/2	10	9-1/2	SSD10T90	1.21
12	21-1/2	11	10-1/2	SSD12T90	1.21
14	23-1/2	12	11-1/2	SSD14T90	1.21
16	25-1/2	13	12-1/2	SSD16T90	1.21
18	27-1/2	14	13-1/2	SSD18T90	1.21
20	29-1/2	15	14-1/2	SSD20T90	1.21
22	31-1/2	16	15-1/2	SSD22T90	1.21
24	33-1/2	17	16-1/2	SSD24T90	1.21

Available with smaller snout and custom height.

Figure 43

SSID 90-Degree Tee					
Ø (in.)	Height (in.)	Offset (in.)	Rise (in.)	Product Code	K Factor
3	15-1/2	8	7-1/2	SSID3T90	1.21
4	15-1/2	8	7-1/2	SSID4T90	1.21
5	16-1/2	9	8	SSID5T90	1.21
6	17-1/2	9	8-1/2	SSID6T90	1.21
7	18-1/2	10	9	SSID7T90	1.21
8	19-1/2	10	9-1/2	SSID8T90	1.21
9	N/A	N/A	N/A	N/A	N/A
10	21-1/2	11	10-1/2	SSID10T90	1.21
12	23-1/2	12	11-1/2	SSID12T90	1.21
14	25-1/2	13	12-1/2	SSID14T90	1.21
16	27-1/2	14	13-1/2	SSID16T90	1.21
18	29-1/2	15	14-1/2	SSID18T90	1.21
20	31-1/2	16	15-1/2	SSID20T90	1.21
22	33-1/2	17	16-1/2	SSID22T90	1.21
24	N/A	N/A	N/A	N/A	N/A

Available with smaller snout and custom height.

Figure 44 NOTE: SSID 9" and 24" not available.

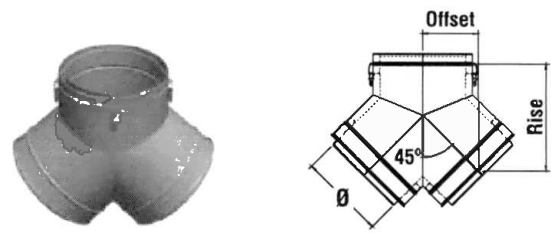

SSD 90-Degree Tee Y				
Ø (in.)	Offset (in.)	Rise (in.)	Product Code	K Factor
3	5	10-3/8	SSD3TY90	0.6
4	5	10-3/8	SSD4TY90	0.6
5	5-5/8	11-1/8	SSD5TY90	0.6
6	5-5/8	11-1/8	SSD6TY90	0.6
7	6-3/8	11-3/4	SSD7TY90	0.6
8	6-3/8	11-3/4	SSD8TY90	0.6
9	7-1/8	13-1/2	SSD9TY90	0.6
10	7-1/8	13-1/2	SSD10TY90	0.6
12	7-3/4	14-1/4	SSD12TY90	0.6
14	8-1/2	15-7/8	SSD14TY90	0.6
16	9-1/4	17-5/8	SSD16TY90	0.6
18	9-7/8	18-3/8	SSD18TY90	0.6
20	10-5/8	21	SSD20TY90	0.6
22	11-3/8	21-3/4	SSD22TY90	0.6
24	12	22-1/2	SSD24TY90	0.6

Available with smaller snout.

Figure 45

SSID 90-Degree Tee Y				
Ø (in.)	Offset (in.)	Rise (in.)	Product Code	K Factor
3	5-5/8	11-1/8	SSID3TY90	0.6
4	5-5/8	11-1/8	SSID4TY90	0.6
5	6-3/8	11-3/4	SSID5TY90	0.6
6	6-3/8	11-3/4	SSID6TY90	0.6
7	7-1/8	13-1/2	SSID7TY90	0.6
8	7-1/8	13-1/2	SSID8TY90	0.6
9	N/A	N/A	N/A	N/A
10	7-3/4	14-1/4	SSID10TY90	0.6
12	8-1/2	15-7/8	SSID12TY90	0.6
14	9-1/4	17-5/8	SSID14TY90	0.6
16	9-7/8	18-3/8	SSID16TY90	0.6
18	10-5/8	21	SSID18TY90	0.6
20	11-3/8	21-3/4	SSID20TY90	0.6
22	12	22-1/2	SSID22TY90	0.6
24	N/A	N/A	N/A	N/A

Available with smaller snout.

Figure 46 NOTE: SSID 9" and 24" not available

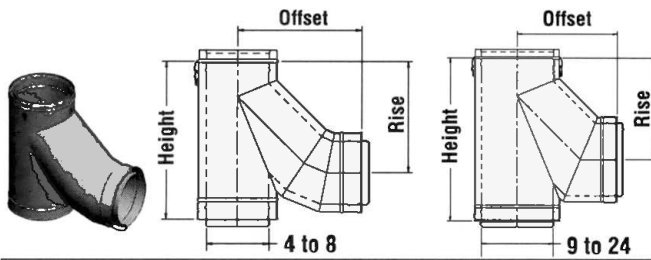

SSD Lateral Secure Tee					
Ø (in.)	Height (in.)	Offset (in.)	Rise (in.)	Product Code	K Factor
3	14-3/8	11-5/8	10	SSD3BT	0.55
4	14-3/8	11-5/8	10	SSD4BT	0.55
5	16-3/8	12-1/4	11	SSD5BT	0.55
6	17-3/8	13-3/4	12-1/4	SSD6BT	0.55
7	19-3/8	14-3/4	13-1/4	SSD7BT	0.55
8	20-3/8	16	14-3/8	SSD8BT	0.55
9	23-3/8	14-1/4	14-1/4	SSD9BT	0.55
10	25-3/8	15-1/4	15-1/4	SSD10BT	0.55
12	27-3/8	16-7/8	17	SSD12BT	0.55
14	30-3/8	18-7/8	18-7/8	SSD14BT	0.55
16	33-3/8	20-3/4	20-3/4	SSD16BT	0.55
18	38-1/8	22-1/2	22-1/2	SSD18BT	0.55
20	42-1/8	24-3/8	24-3/8	SSD20BT	0.55
22	45-1/8	26-1/4	26-1/4	SSD22BT	0.55
24	51-1/8	28	28-1/8	SSD24BT	0.55

Available with smaller snout and custom height.

Figure 47

SSID Lateral Secure Tee					
Ø (in.)	Height (in.)	Offset (in.)	Rise (in.)	Product Code	K Factor
3	17-3/8	13-3/4	12-1/4	SSID3BT	0.55
4	17-3/8	13-3/4	12-1/4	SSID4BT	0.55
5	19-3/8	14-3/4	13-1/4	SSID5BT	0.55
6	20-3/8	16	14-3/8	SSID6BT	0.55
7	23-3/8	14-1/4	14-1/4	SSID7BT	0.55
8	25-3/8	15-1/4	15-1/4	SSID8BT	0.55
9	N/A	N/A	N/A	N/A	N/A
10	27-3/8	16-7/8	17	SSID10BT	0.55
12	30-3/8	18-7/8	18-7/8	SSID12BT	0.55
14	33-3/8	20-3/4	20-3/4	SSID14BT	0.55
16	38-1/8	22-1/2	22-1/2	SSID16BT	0.55
18	42-1/8	24-3/4	24-3/8	SSID18BT	0.55
20	45-1/8	26-1/4	26-1/4	SSID20BT	0.55
22	51-1/8	28	28-1/8	SSID22BT	0.55
24	N/A	N/A	N/A	N/A	N/A

Available with smaller snout and custom height.

Figure 48 NOTE. SSID 9" and 24" not available

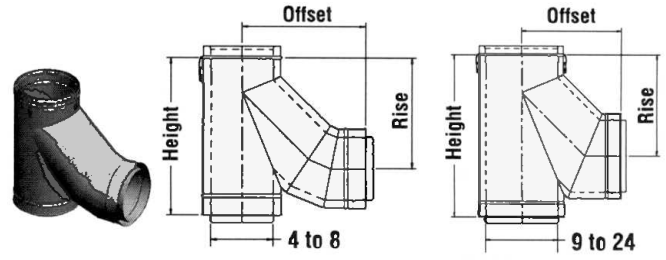

SSD Lateral Secure Tee 88-Degree					
Ø (in.)	Height (in.)	Offset (in.)	Rise (in.)	Product Code	K Factor
3	14-3/8	11-5/8	10-1/4	SSD3BT88	0.55
4	14-3/8	11-5/8	10-1/4	SSD4BT88	0.55
5	16-3/8	12-1/4	11-3/8	SSD5BT88	0.55
6	17-1/2	13-3/4	12-3/4	SSD6BT88	0.55
7	19-3/8	14-7/8	13-3/4	SSD7BT88	0.55
8	20-3/8	16-1/8	15	SSD8BT88	0.55
9	23-3/8	14-1/2	15-1/4	SSD9BT88	0.55
10	25-3/8	15-3/8	16-1/8	SSD10BT88	0.55
12	28-3/8	17	17-7/8	SSD12BT88	0.55
14	31-3/8	19-1/8	20-1/8	SSD14BT88	0.55
16	33-3/8	21	22	SSD16BT88	0.55
18	38-3/8	22-7/8	24	SSD18BT88	0.55
20	42-1/8	24-3/4	26	SSD20BT88	0.55
22	45-1/8	26-5/8	28	SSD22BT88	0.55
24	51-1/8	28-1/2	29-7/8	SSD24BT88	0.55

Available with smaller snout and custom height.

Figure 49

SSID Lateral Secure Tee 88-Degree					
Ø (in.)	Height (in.)	Offset (in.)	Rise (in.)	Product Code	K Factor
3	17-1/2	13-3/4	12-3/4	SSID3BT88	0.55
4	17-1/2	13-3/4	12-3/4	SSID4BT88	0.55
5	19-3/8	14-7/8	13-3/4	SSID5BT88	0.55
6	20-3/8	16-1/8	15	SSID6BT88	0.55
7	23-3/8	14-1/2	15-1/4	SSID7BT88	0.55
8	25-3/8	15-3/8	16-1/8	SSID8BT88	0.55
9	N/A	N/A	N/A	N/A	N/A
10	28-3/8	17	17-7/8	SSID10BT88	0.55
12	31-3/8	19-1/8	20-1/8	SSID12BT88	0.55
14	33-3/8	21	22	SSID14BT88	0.55
16	38-3/8	22-7/8	24	SSID16BT88	0.55
18	42-1/8	24-3/4	26	SSID18BT88	0.55
20	45-1/8	26-5/8	28	SSID20BT88	0.55
22	51-1/8	28-1/2	29-7/8	SSID22BT88	0.55
24	N/A	N/A	N/A	N/A	N/A

Available with smaller snout and custom height.

Figure 50 NOTE. SSID 9" and 24" not available

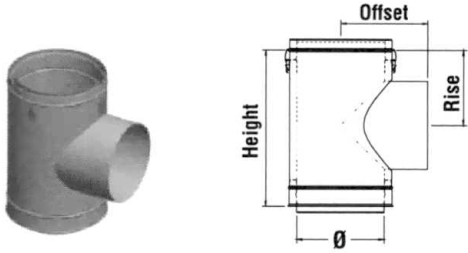

SSD Barometric Tee					
Ø (in.)	Height (in.)	Offset (in.)	Rise (in.)	Product Code	K Factor
3	13-1/2	5	6-1/2	SSD3BMT	0.2
4	13-1/2	5	6-1/2	SSD4BMT	0.2
5	14-1/2	5	7	SSD5BMT	0.2
6	15-1/2	6	7-1/2	SSD6BMT	0.2
7	16-1/2	7	8	SSD7BMT	0.2
8	17-1/2	8	8-1/2	SSD8BMT	0.2
9	18-1/2	9	9	SSD9BMT	0.2
10	19-1/2	10	9-1/2	SSD10BMT	0.2
12	21-1/2	12	10-1/2	SSD12BMT	0.2
14	23-1/2	14	11-1/2	SSD14BMT	0.2
16	25-1/2	16	12-1/2	SSD16BMT	0.2
18	27-1/2	18	13-1/2	SSD18BMT	0.2
20	29-1/2	20	14-1/2	SSD20BMT	0.2
22	31-1/2	22	15-1/2	SSD22BMT	0.2
24	33-1/2	24	16-1/2	SSD24BMT	0.2

Available with smaller snout and custom height.

Figure 51

SSID Barometric Tee					
Ø (in.)	Height (in.)	Offset (in.)	Rise (in.)	Product Code	K Factor
3	15-1/2	6	7-1/2	SSID3BMT	0.2
4	15-1/2	6	7-1/2	SSID4BMT	0.2
5	16-1/2	7	8	SSID5BMT	0.2
6	17-1/2	8	8-1/2	SSID6BMT	0.2
7	18-1/2	9	9	SSID7BMT	0.2
8	19-1/2	10	9-1/2	SSID8BMT	0.2
9	N/A	N/A	N/A	N/A	N/A
10	21-1/2	12	10-1/2	SSID10BMT	0.2
12	23-1/2	14	11-1/2	SSID12BMT	0.2
14	25-1/2	16	12-1/2	SSID14BMT	0.2
16	27-1/2	18	13-1/2	SSID16BMT	0.2
18	29-1/2	20	14-1/2	SSID18BMT	0.2
20	31-1/2	22	15-1/2	SSID20BMT	0.2
22	33-1/2	24	16-1/2	SSID22BMT	0.2
24	N/A	N/A	N/A	N/A	N/A

Available with smaller snout and custom height.

Figure 52 NOTE: SSID 9" and 24" not available

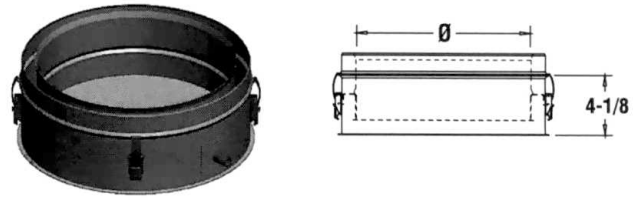

SSD & SSID Tee Cap			
Ø (in.)	Height (in.)	Product Code SSD	Product Code SSID
3 to 24	4-1/8	SSDØTC	SSIDØTC

Figure 53

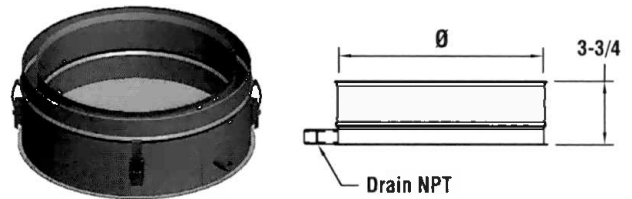

SSD & SSID Drain Tee Cap			
Ø (in.)	Height (in.)	Product Code SSD	Product Code SSID
3 to 24	4-1/8	SSDØDTC	SSIDØDTC

Drain Ø4 – Ø10, 1/4 NPT, 1/2 O.D
Drain Ø12 – Ø24, 3/8 NPT, 5/8 O.D

Figure 54

SSD & SSID VENTING ACCESSORIES

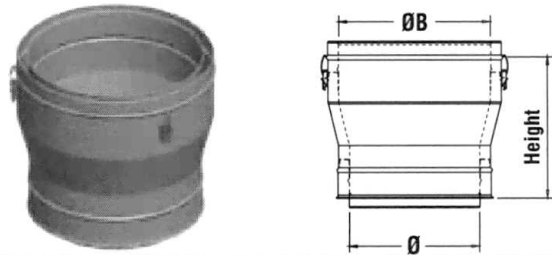

SSD & SSID Tapered Increaser					
Ø (in.)	ØB Available (in.)	Height (in.)	Product Code SSD	Product Code SSID	K Factor
3 to 9	Ø+1	12-1/8	SSDØTIN(ØB)	SSIDØTIN(ØB)	0.05
3 to 22	Ø+2	13-1/8	SSDØTIN(ØB)	SSIDØTIN(ØB)	0.10
3 to 9	Ø+3	14-1/8	SSDØTIN(ØB)	SSIDØTIN(ØB)	0.15
3 to 20	Ø+4	15-1/8	SSDØTIN(ØB)	SSIDØTIN(ØB)	0.20
3 to 7	Ø+5	16-1/8	SSDØTIN(ØB)	SSIDØTIN(ØB)	0.25
3 to 18	Ø+6	17-1/8	SSDØTIN(ØB)	SSIDØTIN(ØB)	0.30

Figure 55

NOTE: SSID 9" and 24" not available.

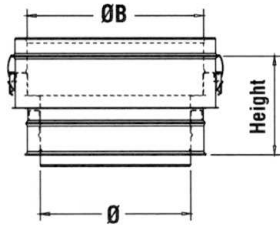

SSD & SSID Step Inserter					
Ø (in.)	ØB Available (in.)	Height (in.)	Product Code SSD	Product Code SSID	K Factor
3 to 22	5 to 24	8	SSDØSIN(ØB)	SSIDØSIN(ØB)	$KØ = (1-\beta^2)^2$ $KØB = KØ/\beta^4$ $\beta = Ø/ØB$

Figure 56

NOTE: SSID 9" and 24" not available.

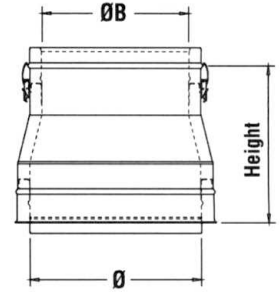

SSD & SSID Tapered Reducer					
Ø (in.)	ØB Available (in.)	Height (in.)	Product Code SSD	Product Code SSID	K Factor
5 to 10	Ø-1	12-7/16	SSDØTRD(ØB)	SSIDØTRD(ØB)	0.07
6 to 24	Ø-2	13-7/16	SSDØTRD(ØB)	SSIDØTRD(ØB)	0.09
6 to 12	Ø-3	14-7/16	SSDØTRD(ØB)	SSIDØTRD(ØB)	0.11
8 to 24	Ø-4	15-7/16	SSDØTRD(ØB)	SSIDØTRD(ØB)	0.13
9 to 24	Ø-5	16-7/16	SSDØTRD(ØB)	SSIDØTRD(ØB)	0.15
10 to 24	Ø-6	17-7/16	SSDØTRD(ØB)	SSIDØTRD(ØB)	0.17

Figure 59

NOTE: SSID 9" and 24" not available

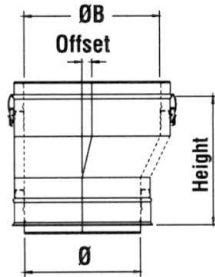

SSD & SSID Eccentric Tapered Inserter						
Ø (in.)	ØB Available (in.)	Height (in.)	Offset (in.)	Product Code SSD	Product Code SSID	K Factor
3 to 9	Ø+1	12-1/2	1/2	SSDØETIN(ØB)	SSIDØETIN(ØB)	0.05
3 to 22	Ø+2	13-1/2	1	SSDØETIN(ØB)	SSIDØETIN(ØB)	0.10
3 to 9	Ø+3	14-1/2	1-1/2	SSDØETIN(ØB)	SSIDØETIN(ØB)	0.15
3 to 20	Ø+4	15-1/2	2	SSDØETIN(ØB)	SSIDØETIN(ØB)	0.20
3 to 7	Ø+5	16-1/2	2-1/2	SSDØETIN(ØB)	SSIDØETIN(ØB)	0.25
3 to 18	Ø+6	17-1/2	3	SSDØETIN(ØB)	SSIDØETIN(ØB)	0.30

Figure 57

NOTE: SSID 9" and 24" not available

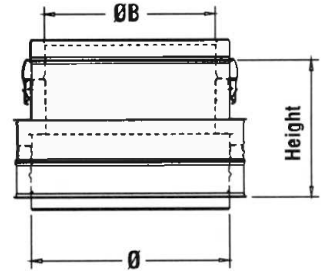

SSD & SSID Step Reducer					
Ø (in.)	ØB Available (in.)	Height (in.)	Product Code SSD	Product Code SSID	K Factor
5 to 24	3 to 22	8	SSDØSRD(ØB)	SSIDØSRD(ØB)	$KØB = 0.5(1-\beta^2)$ $KØ = KØB/\beta^4$ $\beta = ØB/Ø$

Figure 60

NOTE: SSID 9" and 24" not available.

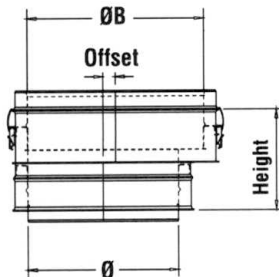

SSD & SSID Eccentric Step Inserter						
Ø (in.)	ØB Available (in.)	Height (in.)	Offset (in.)	Product Code SSD	Product Code SSID	K Factor
3 to 22	5 to 24	8	(ØB-ØA)/2	SSDØESIN(ØB)	SSIDØESIN(ØB)	$KØ = (1-\beta^2)^2$ $KØB = KØ/\beta^4$ $\beta = Ø/ØB$

Figure 58

NOTE: SSID 9" and 24" not available

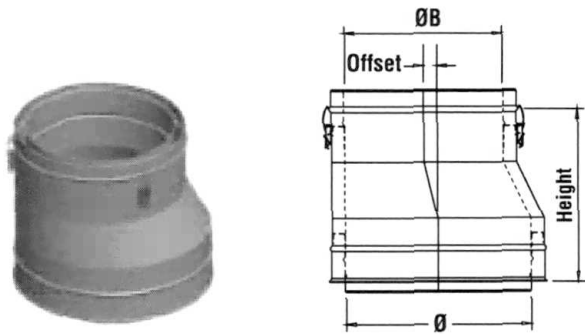

SSD & SSID Eccentric Tapered Reducer						
Ø (in.)	ØB Available (in.)	Height (in.)	Offset (in.)	Product Code SSD	Product Code SSID	K Factor
5 to 10	Ø-1	12-1/2	1/2	SSDØETRD(ØB)	SSIDØETRD(ØB)	0.07
6 to 24	Ø-2	13-1/2	1	SSDØETRD(ØB)	SSIDØETRD(ØB)	0.09
6 to 12	Ø-3	14-1/2	1-1/2	SSDØETRD(ØB)	SSIDØETRD(ØB)	0.11
8 to 24	Ø-4	15-1/2	2	SSDØETRD(ØB)	SSIDØETRD(ØB)	0.13
9 to 24	Ø-5	16-1/2	2-1/2	SSDØETRD(ØB)	SSIDØETRD(ØB)	0.15
10 to 24	Ø-6	17-1/2	3	SSDØETRD(ØB)	SSIDØETRD(ØB)	0.17

Figure 61 NOTE: SSID 9" and 24" not available.

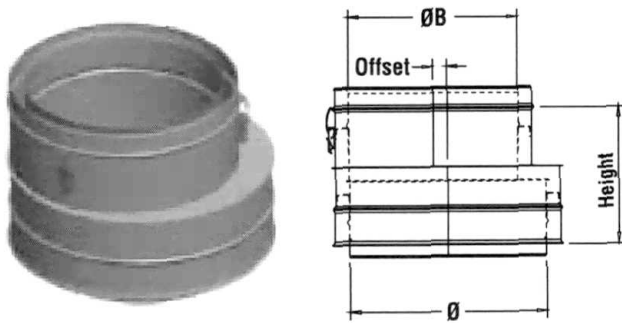

SSD & SSID Eccentric Step Reducer			
Ø (in.)	ØB Available (in.)	Height (in.)	Offset (in.)
5 to 24	3 to 22	8	$(\text{ØA} - \text{ØB})/2$
Product Code SSD		Product Code SSID	
SSDØESRD(ØB)		SSIDØESRD(ØB)	
K Factor			
$K_{\text{ØB}} = 0.5 (1 - \frac{\text{ØB}}{\text{Ø}})$ $K_{\text{Ø}} = K_{\text{ØB}} / \frac{\text{ØB}}{\text{Ø}} = \text{ØB} / \text{Ø}$			

Figure 62 NOTE: SSID 9" and 24" not available

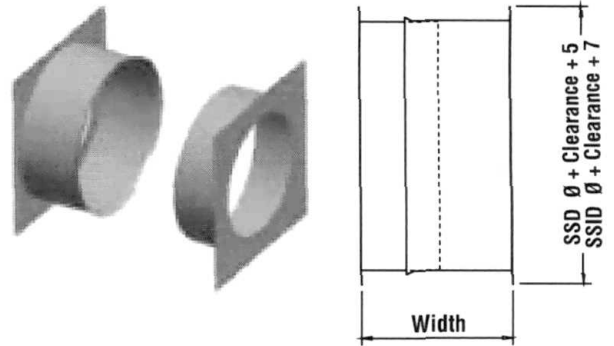

SSD & SSID Wall Thimble			
Ø (in.)	Width (in.)	Product Code SSD	Product Code SSID
3 to 24	9 to 17	SSDØWT	SSIDØWT

Figure 63 NOTE: SSID 9" and 24" not available.

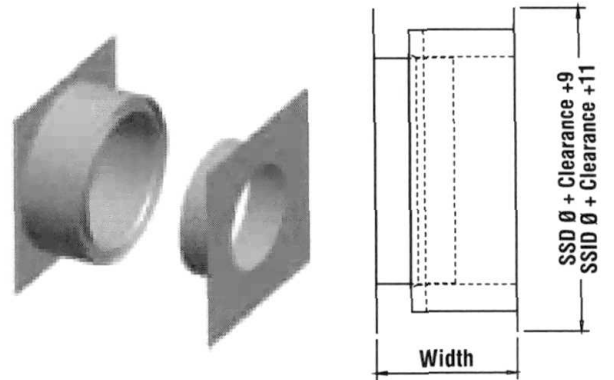

SSD & SSID Wall Thimble Insulated			
Ø (in.)	Width (in.)	Product Code SSD	Product Code SSID
3 to 24	9 to 17	SSDØWTI	SSIDØWTI

Figure 64 NOTE: SSID 9" and 24" not available.

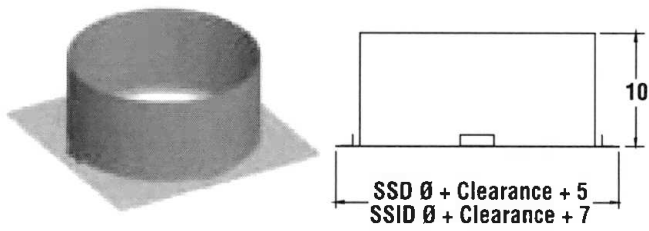

SSD & SSID Roof Thimble			
Ø (in.)	Width (in.)	Product Code SSD	Product Code SSID
3 to 24	10	SSDØRT	SSIDØRT

Figure 65 NOTE: SSID 9" and 24" not available.

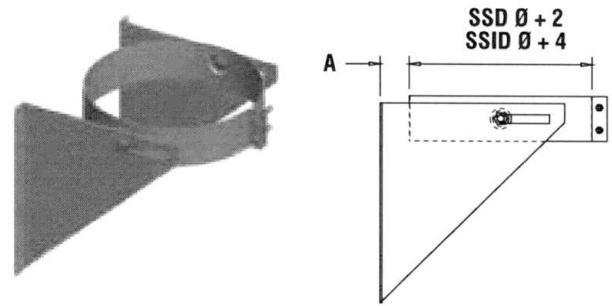

SSD & SSID Wall Support			
Ø (in.)	A (in.)	Product Code SSD	Product Code SSID
3 to 24	1 to 3	SSDØWS	SSIDØWS

Figure 69 NOTE: SSID 9" and 24" not available.

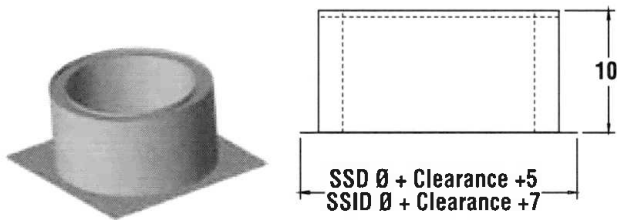

SSD & SSID Roof Thimble Insulated			
Ø (in.)	Width (in.)	Product Code SSD	Product Code SSID
3 to 24	10	SSDØRTI	SSIDØRTI

Figure 66 NOTE: SSID 9" and 24" not available.

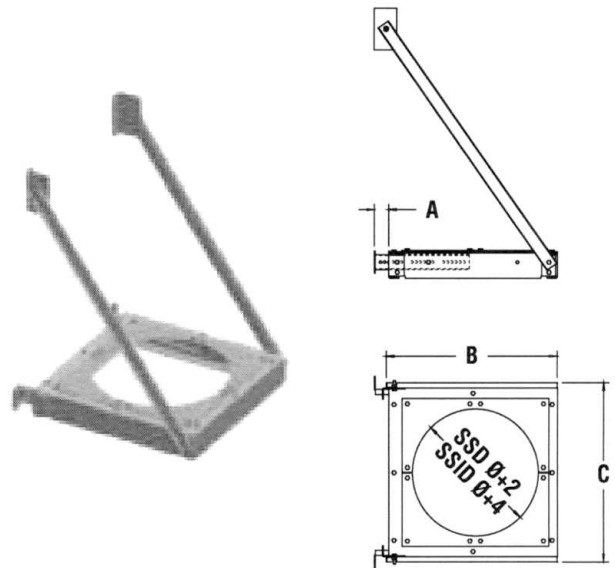

SSD Wall Suort HD				
Ø (in.)	A (in.)	B (in.)	C (in.)	Product Code
3	1-1/2 to 6-1/2	9	12	SSD3WSHD
4	1-1/2 to 6-1/2	9	12	SSD4WSHD
5	1-1/2 to 6-1/2	10	12	SSD5WSHD
6	1-1/2 to 6-1/2	11	12	SSD6WSHD
7	1-1/2 to 6-1/2	12	14	SSD7WSHD
8	1-1/2 to 6-1/2	13	14	SSD8WSHD
9	1-1/2 to 6-1/2	14	14	SSD9WSHD
10	1-1/2 to 6-1/2	15	16	SSD10WSHD
12	1-1/2 to 6-1/2	17	16	SSD12WSHD
14	1-1/2 to 6-1/2	19	22	SSD14WSHD
16	1-1/2 to 6-1/2	21	22	SSD16WSHD
18	1-1/2 to 6-1/2	23	26	SSD18WSHD
20	1-1/2 to 6-1/2	25	30	SSD20WSHD
22	1-1/2 to 6-1/2	27	30	SSD22WSHD
24	1-1/2 to 6-1/2	29	30	SSD24WSHD

Figure 70

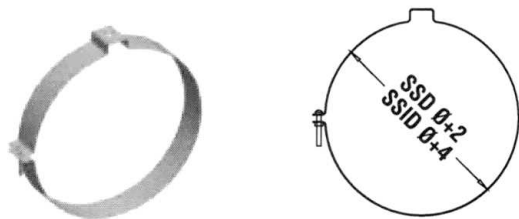

SSD & SSID Suspension Band		
Ø (in.)	Product Code SSD	Product Code SSID
3 to 24	SSDØSB	SSIDØSB

Figure 67 NOTE: SSID 9" and 24" not available.

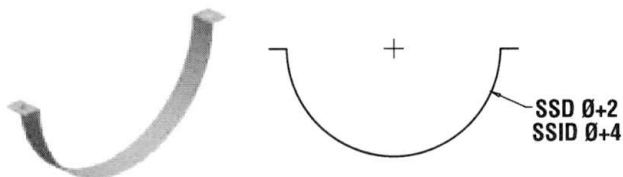

SSD & SSID Cradle Support		
Ø (in.)	Product Code SSD	Product Code SSID
3 to 24	SSDØCS	SSIDØCS

Figure 68 NOTE: SSID 9" and 24" not available.

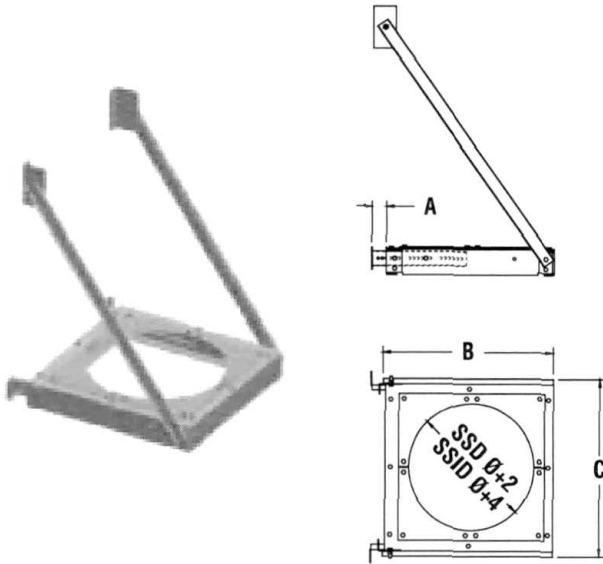

SSID Wall Support HD				
Ø (in.)	A (in.)	B (in.)	C (in.)	Product Code
3	1-1/2 to 6-1/2	11	12	SSID3WSHD
4	1-1/2 to 6-1/2	11	12	SSID4WSHD
5	1-1/2 to 6-1/2	12	14	SSID5WSHD
6	1-1/2 to 6-1/2	13	14	SSID6WSHD
7	1-1/2 to 6-1/2	14	14	SSID7WSHD
8	1-1/2 to 6-1/2	15	16	SSID8WSHD
9	N/A	N/A	N/A	N/A
10	1-1/2 to 6-1/2	17	16	SSID10WSHD
12	1-1/2 to 6-1/2	19	22	SSID12WSHD
14	1-1/2 to 6-1/2	21	22	SSID14WSHD
16	1-1/2 to 6-1/2	23	26	SSID16WSHD
18	1-1/2 to 6-1/2	25	30	SSID18WSHD
20	1-1/2 to 6-1/2	27	30	SSID20WSHD
22	1-1/2 to 6-1/2	29	30	SSID22WSHD
24	N/A	N/A	N/A	N/A

Figure 71 NOTE: SSID 9" and 24" not available.

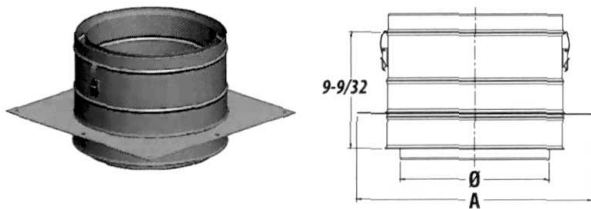

SSID Anchor Plate Length (APL)		
Ø (in.)	A (in.)	Product Code
3 to 24	Ø + 7	SSDØAPL

SSID Anchor Plate Length (APL)		
Ø (in.)	A (in.)	Product Code
3 to 22	Ø + 9	SSIDØAPL

Figure 72 NOTE: SSID 9" and 24" not available.

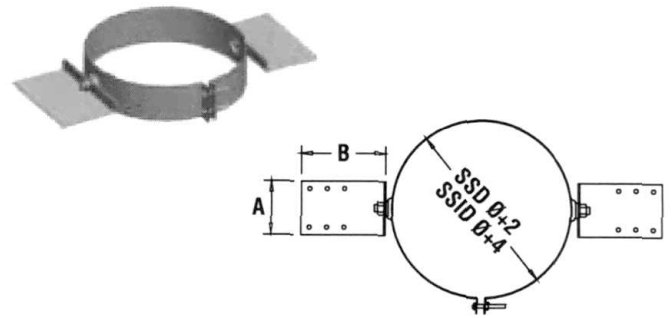

SSD & SSID Roof Support				
Ø (in.)	A (in.)	B (in.)	Product Code SSD	Product Code SSID
3 to 24	6-1/2	7-5/8	SSDØRS	SSIDØRS

Figure 73 NOTE: SSID 9" and 24" not available

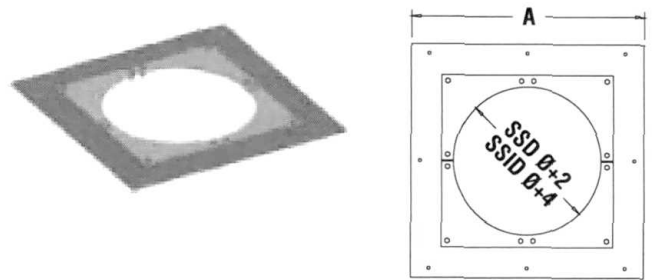

SSD & SSID Anchor Plate			
Ø (in.)	A (in.)	Product Code SSD	Product Code SSID
3 to 24	Ø+7	SSDØAP	SSIDØAP

Figure 74 NOTE: SSID 9" and 24" not available.

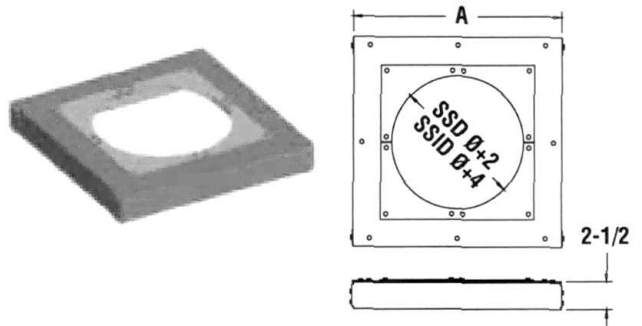

SSD & SSID Anchor Plate HD			
Ø (in.)	A (in.)	Product Code SSD	Product Code SSID
3 to 24	Ø+7	SSDØAPHD	SSIDØAPHD

Figure 75 NOTE: SSID 9" and 24" not available.

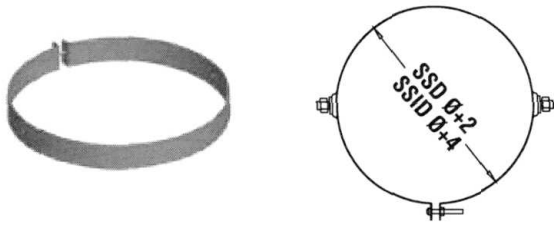

SSD & SSID Roof Brace		
Ø (in.)	Product Code SSD	Product Code SSID
3 to 24	SSDØRB	SSIDØRB

Figure 76 NOTE: SSID 9" and 24" not available.

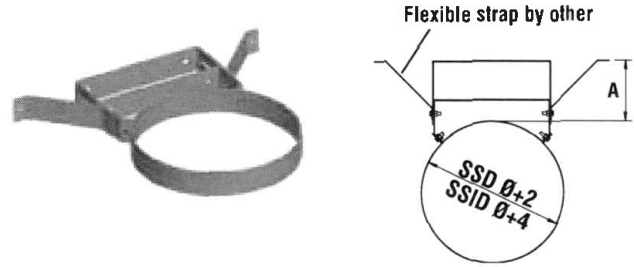

SSD & SSID Wall Guide			
Ø (in.)	A (in.)	Product Code SSD	Product Code SSID
3 to 24	1 to 4-1/2	SSDØWG	SSIDØWG

Figure 79 NOTE: SSID 9" and 24" not available

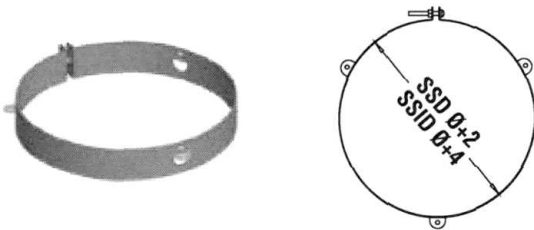

SSD & SSID Guy Wire Band		
Ø (in.)	Product Code SSD	Product Code SSID
3 to 24	SSDØGWB	SSIDØGWB

Figure 77 NOTE: SSID 9" and 24" not available.

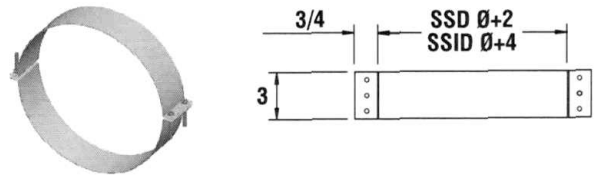

SSD & SSID Guy Support		
Ø (in.)	Product Code SSD	Product Code SSID
3 to 24	SSDØGS	SSIDØGS

Figure 80 NOTE: SSID 9" and 24" not available

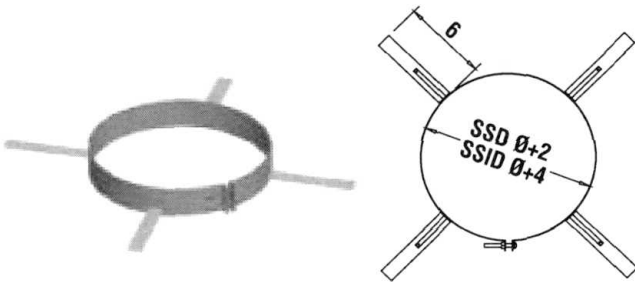

SSD & SSID Centering Band		
Ø (in.)	Product Code SSD	Product Code SSID
3 to 24	SSDØCB	SSIDØCB

Figure 78 NOTE: SSID 9" and 24" not available.

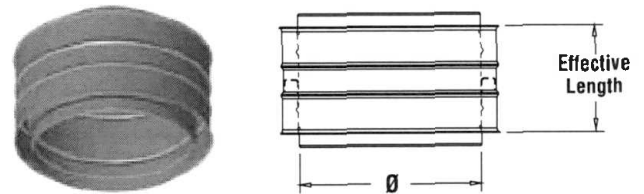

SSD & SSID Double Male Adaptor			
Ø (in.)	Effective Length (in.)	Product Code SSD	Product Code SSID
3 to 24	7-1/8	SSDØDMAU	SSIDØDMAU

Figure 81 NOTE: SSID 9" and 24" not available.

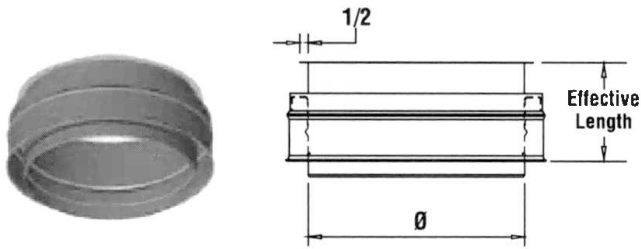

SSD & SSID Male Flange Adaptor			
Ø (in.)	Effective Length (in.)	Product Code SSD	Product Code SSID
3 to 24	5-1/2	SSDØMFA	SSIDØMFA

Figure 82 NOTE: SSID 9" and 24" not available

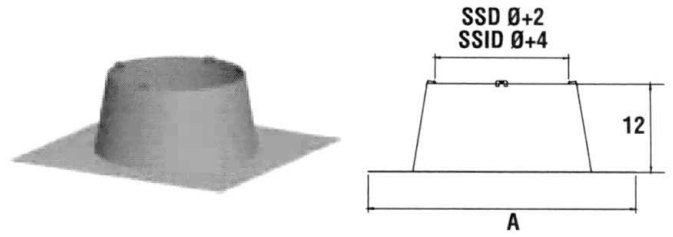

SSD Flat Flashing		
Ø (in.)	A (in.)	Product Code
3	16	SSD3F
4	16	SSD4F
5	18	SSD5F
6	26	SSD6F
7	26	SSD7F
8	28	SSD8F
9	30	SSD9F
10	30	SSD10F
12	31	SSD12F
14	34	SSD14F
16	36	SSD16F
18	38	SSD18F
20	40	SSD20F
22	42	SSD22F
24	44	SSD24F

Figure 85

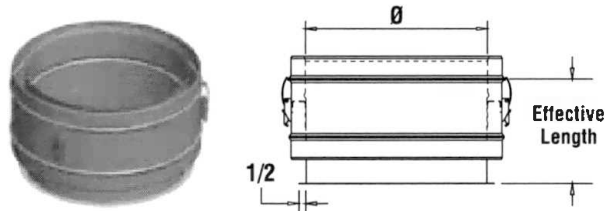

SSD & SSID Female Flange Adaptor			
Ø (in.)	Effective Length (in.)	Product Code SSD	Product Code SSID
3 to 24	6-7/8	SSDØFFA	SSIDØFFA

Figure 83 NOTE: SSID 9" and 24" not available

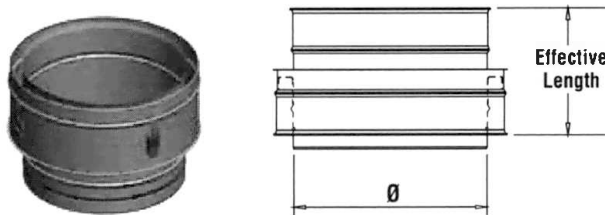

SSD & SSID to SS Adaptor			
Ø (in.)	Effective Length (in.)	Product Code SSD	Product Code SSID
3 to 24	7-7/8	SSDØSSA	SSIDØSSA

Figure 84 NOTE: SSID 9" and 24" not available.

SSID Flat Flasing		
Ø (in.)	A (in.)	Product Code
3	26	SSID3F
4	26	SSID4F
5	26	SSID5F
6	28	SSID6F
7	30	SSID7F
8	30	SSID8F
9	N/A	N/A
10	31	SSID10F
12	34	SSID12F
14	36	SSID14F
16	38	SSID16F
18	40	SSID18F
20	42	SSID20F
22	44	SSID22F
24	N/A	N/A

Figure 86 NOTE: SSID 9" and 24" not available.



Adjustable from 5° to 30°.
Roof pitch 1/12 to 7/12.

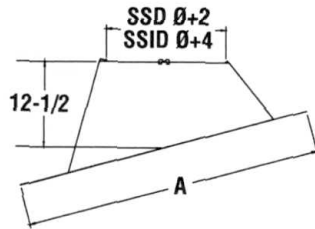

SSD Adjustable Flashing			
Ø (in.)	A (in.)	Height (in.)	Product Code
3	32	12-1/2	SSD3FA
4	32	12-1/2	SSD4FA
5	32	12-1/2	SSD5FA
6	34	12-1/2	SSD6FA
7	35-3/8	12-1/2	SSD7FA
8	36-1/2	12-1/2	SSD8FA
9	38	12-1/2	SSD9FA
10	38-1/2	12-1/2	SSD10FA
12	41	12-1/2	SSD12FA
14	43	12-1/2	SSD14FA
16	45	12-1/2	SSD16FA
18	47-1/4	12-1/2	SSD18FA
20	49-1/2	12-1/2	SSD20FA
22	51-1/2	12-1/2	SSD22FA
24	53-1/2	12-1/2	SSD24FA

Figure 87

SSID Adjustable Flashing			
Ø (in.)	A (in.)	Height (in.)	Product Code
3	34	12-1/2	SSID3FA
4	34	12-1/2	SSID4FA
5	35-3/8	12-1/2	SSID5FA
6	36-1/2	12-1/2	SSID6FA
7	38	12-1/2	SSID7FA
8	38-1/2	12-1/2	SSID8FA
9	N/A	N/A	N/A
10	41	12-1/2	SSID10FA
12	43	12-1/2	SSID12FA
14	45	12-1/2	SSID14FA
16	47-1/4	12-1/2	SSID16FA
18	49-1/2	12-1/2	SSID18FA
20	51-1/2	12-1/2	SSID20FA
22	53-1/2	12-1/2	SSID22FA
24	N/A	N/A	N/A

Figure 88

NOTE: SSID 9" and 24" not available

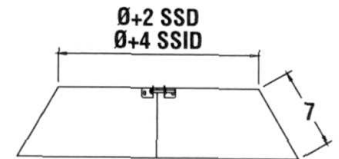

SSD & SSID Storm Collar		
Ø (in.)	Product Code SSD	Product Code SSID
3 to 24	SSDØSC	SSIDØSC

Figure 89

NOTE: SSID 9" and 24" not available.

SSD & SSID VENTING TERMINATIONS

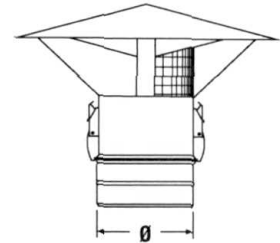

SSD Rain Cap			
Ø (in.)	Product Code SSD	Product Code with Bird Screen SSD	K Factor
3 to 24	SSDØRC	SSDØRCB	.50

SSID Rain Cap			
Ø (in.)	Product Code SSID	Product Code with Bird Screen SSID	K Factor
3 to 24	SSIDØRC	SSIDØRCB	.50

Figure 90

NOTE: SSID 9" and 24" not available.

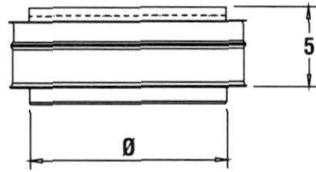

SSD & SSID Screened Termination			
\emptyset (in.)	Product Code SSD	Product Code SSID	K Factor
3 to 24	SSD \emptyset STU	SSID \emptyset ST	.14

Figure 91 NOTE: SSID 9" and 24" not available.

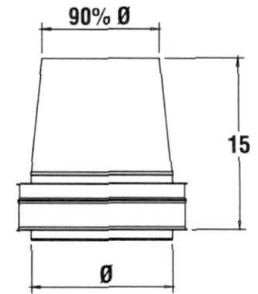

SSD & SSID Exit Cone			
\emptyset (in.)	Product Code SSD	Product Code SSID	K Factor
3 to 24	SSD \emptyset EC	SSID \emptyset EC	.60

Figure 93 NOTE: SSID 9" and 24" not available.

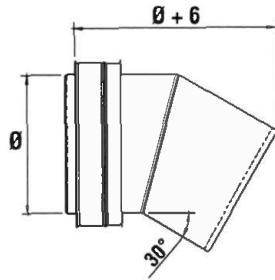
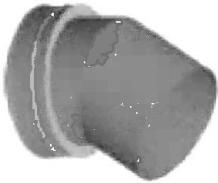

SSD & SSID 30° Screen Termination			
\emptyset (in.)	Product Code SSD	Product Code SSID	K Factor
3 to 24	SSD \emptyset STAU	SSID \emptyset STA	.70

Figure 92 NOTE: SSID 9" and 24" not available.

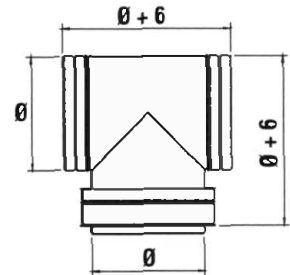

SSD & SSID Termination Tee			
\emptyset (in.)	Product Code SSD	Product Code SSID	K Factor
3 to 24	SSD \emptyset TT	SSID \emptyset TT	.35

Figure 94 NOTE: SSID 9" and 24" not available.

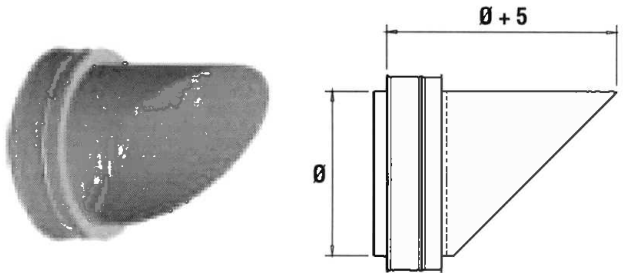

SSD & SSID Mitre Cut			
Ø (in.)	Product Code SSD	Product Code SSID	K Factor
3 to 24	SSDØMCU	SSIDØMCU	.14

Figure 95 NOTE: SSID 9" and 24" not available

SS VENTING LENGTHS

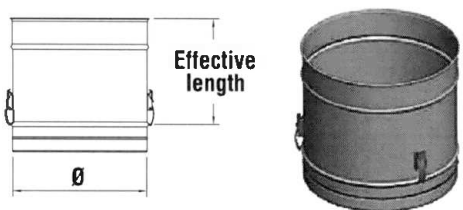

SS Lengths		
Ø (in.)	Effective Length (in.)	Product Code
3 to 24	6-1/2	SSØL9
3 to 24	9-1/2	SSØL12
3 to 24	15-1/2	SSØL18
3 to 24	21-1/2	SSØL24
3 to 24	33-1/2	SSØL36

Figure 98

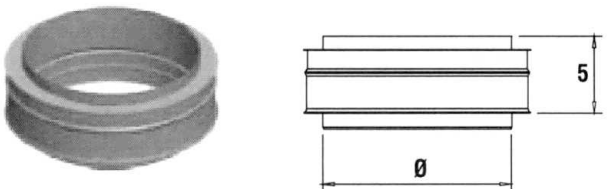

SSD & SSID Closer Termination			
Ø (in.)	Product Code SSD	Product Code SSID	K Factor
3 to 24	SSDØCTU	SSIDØCTU	0

Figure 96 NOTE: SSID 9" and 24" not available.

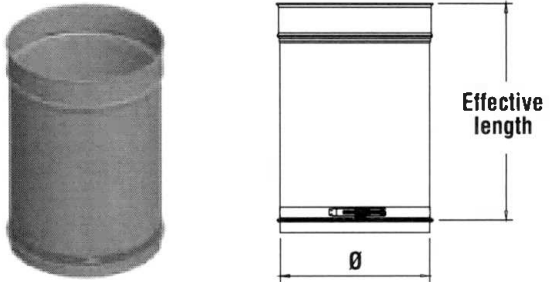

SS Adjustable Lengths		
Ø (in.)	Effective Length (in.)	Product Code
3 to 24	4 to 5	SSØAL9
3 to 24	4 to 14	SSØAL18

Figure 99

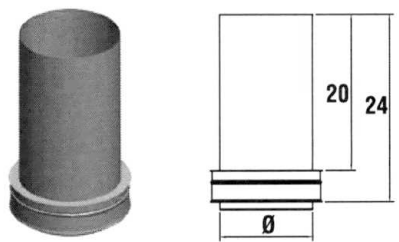

SSD & SSID OEM Termination			
Ø (in.)	Product Code SSD	Product Code SSID	K Factor
3 to 24	SSDØOEMTAU	SSIDØOEMTAU	0

Figure 97 NOTE: SSID 9" and 24" not available.

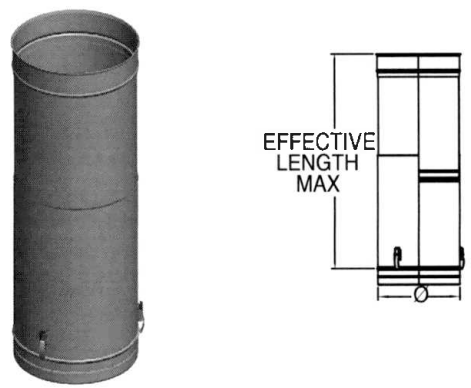

SS Telescopic Lengths			
Ø (in.)	Effective Length (in.)	Product Code 32"	Product Code 20"
3 to 24	14 to 20	SSØLAT32	SSØLAT20
3 to 24	20 to 32	SSØLAT32	SSØLAT20

Figure 99a

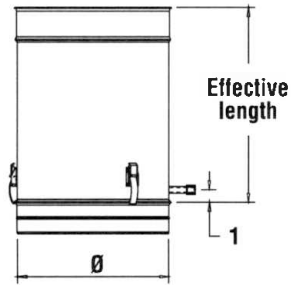
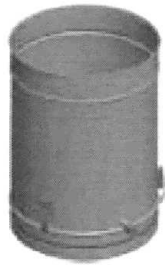

SS Test Port Lengths		
Ø (in.)	Effective Length (in.)	Product Code
3 to 24	6-1/2	SSØTPL
Drain Ø4 – Ø24, 1/4 NPT, 1/2 O.D		

Figure 100

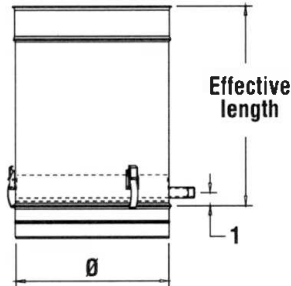
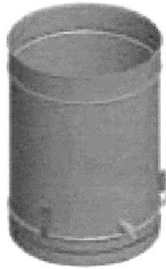

SS Drain Length			
Ø (in.)	Effective Length (in.)	Product Code	K Factor
3 to 24	6-1/2	SSØDL	0.25
Drain Ø4 – Ø10, 1/4 NPT, 1/2 O.D			
Drain Ø12 – Ø24, 1/2 NPT, 5/8 O.D			

Figure 101

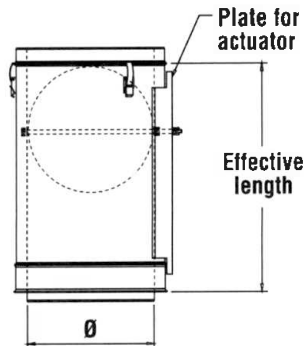
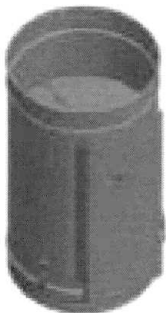

SS Damper Lengths			
Ø (in.)	Effective Length (in.)	Product Code	K Factor
3 to 24	15-1/2	SSØDAMP	0.60 to 9999

Figure 102

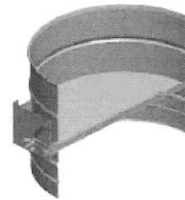

Cross Section View

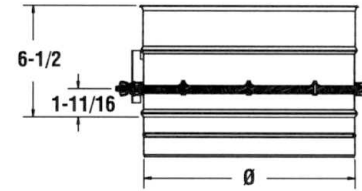

SS Damper Length Short Manual			
Ø (in.)	Effective Length (in.)	Product Code	K Factor
3 to 24	6-1/2	SSØDAMPS	0 to 9999

Figure 103

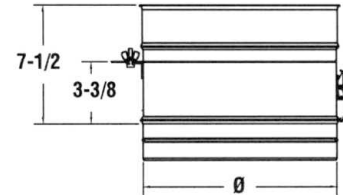

SS Damper Length Short			
Ø (in.)	Effective Length (in.)	Product Code	K Factor
3 to 24	7-1/8	SSØVFR	0 to 9999

Figure 104



Cross Section View

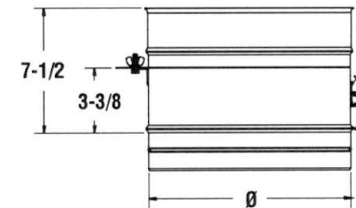

SS Vent Flow Regulator Damper Blade	
Ø (in.)	Product Code
3 to 24	SSØVFN
For use on Cat. I and II boilers only	

Figure 105

SS VENTING ELBOWS

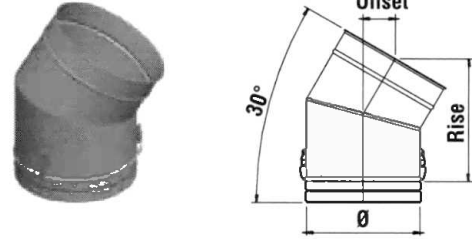
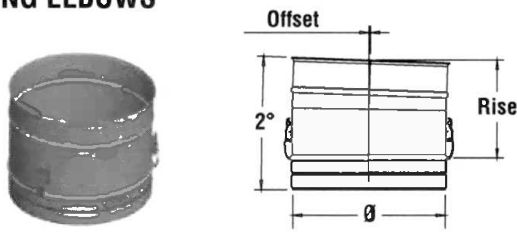

SS 2-Degree Elbow				
Ø (in.)	Offset (in.)	Rise (in.)	Product Code	K Factor
3	1/8	7-1/8	SS3E2	0.04
4	1/8	7-1/8	SS4E2	0.04
5	1/8	7-1/4	SS5E2	0.04
6	1/8	7-1/4	SS6E2	0.04
7	1/8	7-1/4	SS7E2	0.04
8	1/8	7-1/4	SS8E2	0.04
9	1/8	7-3/8	SS9E2	0.04
10	1/8	7-3/8	SS10E2	0.04
12	1/8	7-3/8	SS12E2	0.04
14	1/8	7-1/2	SS14E2	0.03
16	1/8	7-5/8	SS16E2	0.03
18	1/8	7-5/8	SS18E2	0.03
20	1/8	7-3/4	SS20E2	0.03
22	1/8	7-3/4	SS22E2	0.03
24	1/8	7-7/8	SS24E2	0.03

SS 30-Degree Elbow				
Ø (in.)	Offset (in.)	Rise (in.)	Product Code	K Factor
3	2-1/8	8	SS3E30	0.61
4	2-1/4	8-1/2	SS4E30	0.61
5	2-3/8	9	SS5E30	0.60
6	2-5/8	9-1/2	SS6E30	0.59
7	2-3/4	10	SS7E30	0.58
8	2-7/8	10-1/2	SS8E30	0.57
9	3	11	SS9E30	0.56
10	3-1/8	11-1/2	SS10E30	0.55
12	3-3/8	12-1/2	SS12E30	0.54
14	3-5/8	13-1/2	SS14E30	0.54
16	3-7/8	14-1/2	SS16E30	0.53
18	4-1/8	15-1/2	SS18E30	0.52
20	4-1/2	16-1/2	SS20E30	0.52
22	4-3/4	17-1/2	SS22E30	0.51
24	5	18-1/2	SS24E30	0.51

Figure 106

Figure 108

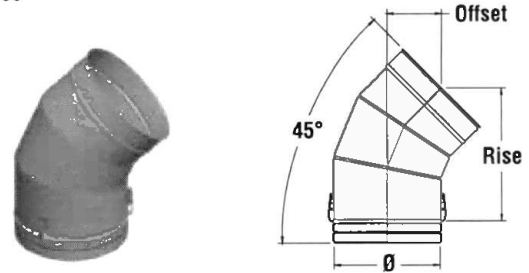
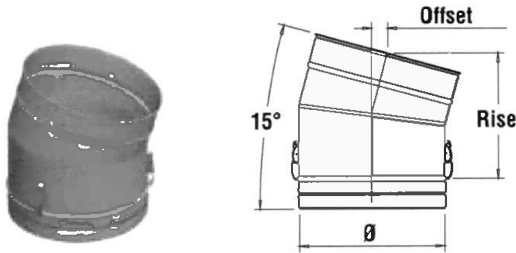

SS 15-Degree Elbow				
Ø (in.)	Offset (in.)	Rise (in.)	Product Code	K Factor
3	1	7-5/8	SS3E15	0.31
4	1	7-7/8	SS4E15	0.31
5	1-1/8	8-1/4	SS5E15	0.30
6	1-1/8	8-1/2	SS6E15	0.30
7	1-1/8	8-3/4	SS7E15	0.29
8	1-1/4	9	SS8E15	0.29
9	1-1/4	9-1/4	SS9E15	0.28
10	1-1/4	9-1/2	SS10E15	0.28
12	1-3/8	10	SS12E15	0.27
14	1-3/8	10-1/2	SS14E15	0.27
16	1-1/2	11	SS16E15	0.26
18	1-1/2	11-1/2	SS18E15	0.26
20	1-5/8	12-1/8	SS20E15	0.26
22	1-5/8	12-5/8	SS22E15	0.26
24	1-3/4	13-1/8	SS24E15U	0.26

SS 45-Degree Elbow				
Ø (in.)	Offset (in.)	Rise (in.)	Product Code	K Factor
3	3-3/8	8-1/8	SS3E45	0.26
4	4-1/4	10-1/4	SS4E45	0.26
5	4	9-1/2	SS5E45	0.22
6	4-1/4	10-1/2	SS6E45	0.17
7	4-1/2	10-7/8	SS7E45	0.16
8	4-7/8	11-5/8	SS8E45	0.14
9	5-1/8	12-3/8	SS9E45	0.13
10	5-3/8	13	SS10E45	0.12
12	6	14-1/2	SS12E45	0.11
14	6-5/8	15-7/8	SS14E45	0.11
16	7-1/8	17-1/4	SS16E45	0.10
18	7-3/4	18-3/4	SS18E45	0.09
20	8-3/8	20-1/8	SS20E45	0.08
22	8-7/8	21-1/2	SS22E45	0.08
24	9-1/2	23	SS24E45	0.08

Figure 107

Figure 109

NOTE: DIAGRAMS & ILLUSTRATIONS ARE NOT TO SCALE.

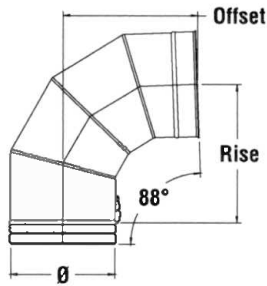

SS 88-Degree Elbow				
Ø (in.)	Offset (in.)	Rise (in.)	Product Code	K Factor
3	6-3/8	6-5/8	SS3E88	0.60
4	7-3/8	7-5/8	SS4E88	0.54
5	8-3/8	8-5/8	SS5E88	0.48
6	9-1/4	9-5/8	SS6E88	0.42
7	10-1/4	10-5/8	SS7E88	0.39
8	11-1/4	11-5/8	SS8E88	0.37
9	12-1/4	12-5/8	SS9E88	0.34
10	13-1/8	13-5/8	SS10E88	0.32
12	15-1/8	15-5/8	SS12E88	0.29
14	17	17-5/8	SS14E88	0.27
16	19	19-5/8	SS16E88	0.25
18	20-7/8	21-5/8	SS18E88	0.24
20	22-7/8	23-5/8	SS20E88	0.23
22	24-3/4	25-5/8	SS22E88	0.21
24	26-5/8	27-5/8	SS24E88	0.20

Figure 110

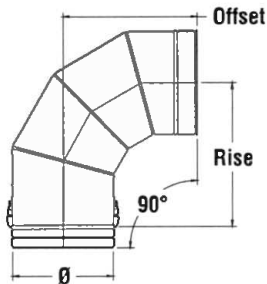

SS 90-Degree Elbow				
Ø (in.)	Offset (in.)	Rise (in.)	Product Code	K Factor
3	6-1/2	6-1/2	SS3E90	0.54
4	7-1/2	7-1/2	SS4E90	0.54
5	8-1/2	8-1/2	SS5E90	0.48
6	9-1/2	9-1/2	SS6E90	0.42
7	10-1/2	10-1/2	SS7E90	0.39
8	11-1/2	11-1/2	SS8E90	0.37
9	12-1/2	12-1/2	SS9E90	0.34
10	13-1/2	13-1/2	SS10E90	0.32
12	15-1/2	15-1/2	SS12E90	0.29
14	17-1/2	17-1/2	SS14E90	0.27
16	19-1/2	19-1/2	SS16E90	0.25
18	21-1/2	21-1/2	SS18E90	0.24
20	23-1/2	23-1/2	SS20E90	0.23
22	25-1/2	25-1/2	SS22E90	0.21
24	27-1/2	27-1/2	SS24E90	0.20

Figure 111

NOTE: DIAGRAMS & ILLUSTRATIONS ARE NOT TO SCALE.

SS VENTING TEES

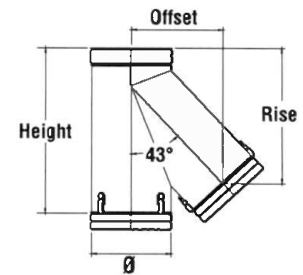

Available with smaller snout and custom height.

SS 43-Degree Tee					
Ø (in.)	Height (in.)	Offset (in.)	Rise (in.)	Product Code	K Factor
3	14-1/4	6-3/8	11-1/8	SS3T43	0.4
4	14-1/4	6-3/8	11-1/8	SS4T43	0.4
5	15-1/4	7-3/4	12-7/8	SS5T43	0.4
6	17-1/4	8-1/2	13-3/4	SS6T43	0.4
7	18-1/4	9-1/8	14-3/4	SS7T43	0.4
8	20-1/4	10-1/2	16-3/8	SS8T43	0.4
9	21-1/4	11-1/4	17-1/4	SS9T43	0.4
10	22-1/4	12-5/8	19	SS10T43	0.4
12	25-1/4	13-7/8	20-3/4	SS12T43	0.4
14	29-1/4	16	23-3/8	SS14T43	0.4
16	32-1/4	17-3/8	25-1/4	SS16T43	0.4
18	35	19-3/8	27-7/8	SS18T43	0.4
20	38	21-3/8	30-3/8	SS20T43	0.4
22	41	22-3/4	32-1/4	SS22T43	0.4
24	44	24-5/8	34-5/8	SS24T43	0.4

Figure 112

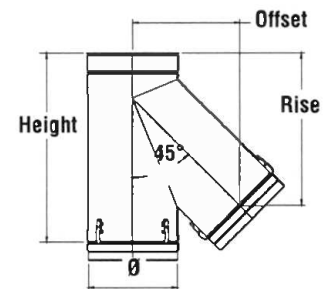

Available with smaller snout and custom height.

SS 45-Degree Tee				
Ø (in.)	Height (in.)	Offset (in.)	Rise (in.)	Product Code
3	14-1/4	6-5/8	11	SS3T45
4	14-1/4	6-5/8	11	SS4T45
5	15-1/4	8-1/8	12-5/8	SS5T45
6	17-1/4	8-3/4	13-1/2	SS6T45
7	18-1/4	9-1/2	14-3/8	SS7T45
8	20-1/4	10-7/8	16	SS8T45
9	21-1/4	11-5/8	17	SS9T45
10	22-1/4	13	17-5/8	SS10T45
12	25-1/4	14-1/2	20-3/8	SS12T45
14	29-1/4	15-7/8	22-1/4	SS14T45
16	32-1/4	18-1/8	24-7/8	SS16T45
18	35	20-1/4	27-1/2	SS18T45
20	38	22-1/4	29-7/8	SS20T45
22	41	23-5/8	31-5/8	SS22T45
24	44	25-1/2	34	SS24T45

Figure 113

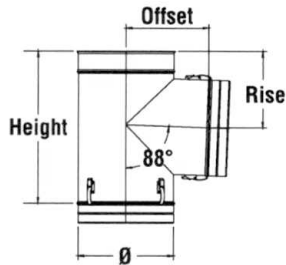

Available with smaller snout and custom height.

SS 88-Degree Tee					
Ø (in.)	Height (in.)	Offset (in.)	Rise (in.)	Product Code	K Factor
3	11-1/4	6-3/8	5-5/8	SS3T88	1.21
4	11-1/4	6-3/8	5-5/8	SS4T88	1.21
5	12-1/4	7-3/8	6-1/4	SS5T88	1.21
6	13-1/4	7-3/8	6-5/8	SS6T88	1.21
7	14-1/4	8-3/8	7-1/4	SS7T88	1.21
8	15-1/4	8-3/8	7-5/8	SS8T88	1.21
9	16-1/4	9-3/8	8-1/4	SS9T88	1.21
10	17-1/4	9-3/8	8-5/8	SS10T88	1.21
12	19-1/4	10-3/8	9-3/4	SS12T88	1.21
14	21-1/4	11-3/8	10-3/4	SS14T88	1.21
16	23-1/4	12-3/8	11-3/4	SS16T88	1.21
18	25-1/4	13-3/8	12-3/4	SS18T88	1.21
20	27-1/4	14-3/8	13-3/4	SS20T88	1.21
22	29-1/4	15-3/8	14-3/4	SS22T88	1.21
24	31-1/4	16-3/8	15-3/4	SS24T88	1.21

Figure 114

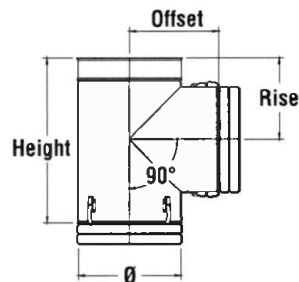

Available with smaller snout and custom height.

SS 90-Degree Tee					
Ø (in.)	Height (in.)	Offset (in.)	Rise (in.)	Product Code	K Factor
3	11-1/4	6-3/8	5-1/2	SS3T90	1.21
4	11-1/4	6-3/8	5-1/2	SS4T90	1.21
5	12-1/4	7-3/8	6	SS5T90	1.21
6	13-1/4	7-3/8	6-1/2	SS6T90	1.21
7	14-1/4	8-3/8	7	SS7T90	1.21
8	15-1/4	8-3/8	7-1/2	SS8T90	1.21
9	16-1/4	9-3/8	8	SS9T90	1.21
10	17-1/4	9-3/8	8-1/2	SS10T90	1.21
12	19-1/4	10-3/8	9-1/2	SS12T90	1.21
14	21-1/4	11-3/8	10-1/2	SS14T90	1.21
16	23-1/4	12-3/8	11-1/2	SS16T90	1.21
18	25-1/4	13-3/8	12-1/2	SS18T90	1.21
20	27-1/4	14-3/8	13-1/2	SS20T90	1.21
22	29-1/4	15-3/8	14-1/2	SS22T90	1.21
24	31-1/4	16-3/8	15-1/2	SS24T90	1.21

Figure 115

NOTE: DIAGRAMS & ILLUSTRATIONS ARE NOT TO SCALE

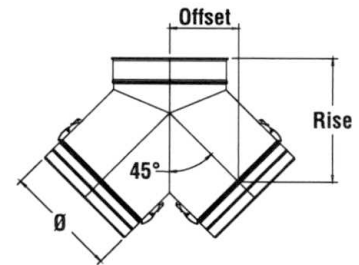

Available with smaller snout and custom height.

SS 90-Degree Tee Y				
Ø (in.)	Offset (in.)	Rise (in.)	Product Code	K Factor
3	4-1/2	8-1/2	SS3TY90	0.6
4	4-1/2	8-1/2	SS4TY90	0.6
5	5-1/4	10-1/8	SS5TY90	0.6
6	5-1/4	10-1/8	SS6TY90	0.6
7	6	10-7/8	SS7TY90	0.6
8	6	10-7/8	SS8TY90	0.6
9	6-5/8	12-5/8	SS9TY90	0.6
10	6-5/8	12-5/8	SS10TY90	0.6
12	7-3/8	13-1/4	SS12TY90	0.6
14	8-1/8	15	SS14TY90	0.6
16	8-3/4	16-3/4	SS16TY90	0.6
18	9-1/2	17-3/8	SS18TY90	0.6
20	10-1/4	18-1/8	SS20TY90	0.6
22	10-7/8	18-7/8	SS22TY90	0.6
24	11-5/8	20-1/2	SS24TY90	0.6

Figure 116

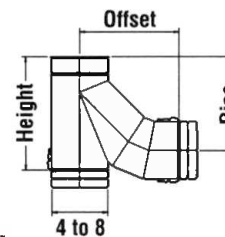

Available with smaller snout and custom height.

SS Lateral Tee					
Ø (in.)	Height (in.)	Offset (in.)	Rise (in.)	Product Code	K Factor
3	10-1/8	9-1/4	8-7/8	SS3BT	0.55
4	10-1/8	9-1/4	8-7/8	SS4BT	0.55
5	12-1/8	10-1/2	10	SS5BT	0.55
6	13-1/8	11-3/4	11-1/8	SS6BT	0.55
7	15-1/8	13	12-1/4	SS7BT	0.55
8	16-1/8	14-1/4	13-3/8	SS8BT	0.55
9	18-1/8	12-1/2	12-1/2	SS9BT	0.55
10	19-1/8	13-3/8	13-3/8	SS10BT	0.55
12	22-1/8	15-1/4	15-1/4	SS12BT	0.55
14	25-1/8	17	17	SS14BT	0.55
16	28-1/8	18-7/8	18-7/8	SS16BT	0.55
18	30-7/8	20-3/4	20-3/4	SS18BT	0.55
20	33-7/8	22-1/2	22-1/2	SS20BT	0.55
22	36-7/8	24-3/8	24-3/8	SS22BT	0.55
24	39-7/8	26-1/8	26-1/4	SS24BT	0.55

Figure 117

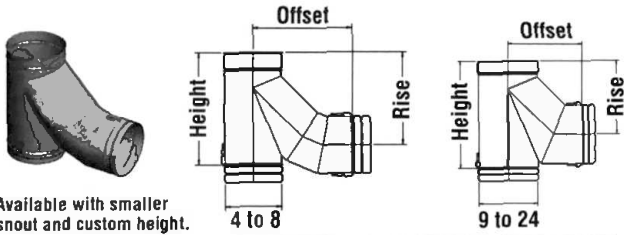

Available with smaller snout and custom height.

SS Lateral Tee 88-Degree					
Ø (in.)	Height (in.)	Offset (in.)	Rise (in.)	Product Code	K Factor
3	11-1/8	9-1/4	9-1/4	SS3BT88	0.55
4	11-1/8	9-1/4	9-1/4	SS4BT88	0.55
5	12-1/8	10-1/2	10-1/2	SS5BT88	0.55
6	14-1/8	11-3/4	11-3/4	SS6BT88	0.55
7	16-1/8	13	13	SS7BT88	0.55
8	17-1/8	14-1/4	14-1/8	SS8BT88	0.55
9	19-1/8	12-5/8	13-1/4	SS9BT88	0.55
10	20-1/8	13-1/2	14-1/4	SS10BT88	0.55
12	23-1/8	15-3/8	16-1/8	SS12BT88	0.55
14	26-1/8	17-3/8	18-1/8	SS14BT88	0.55
16	29-1/8	19-1/8	20-1/8	SS16BT88	0.55
18	31-7/8	21	22	SS18BT88	0.55
20	34-7/8	22-7/8	24	SS20BT88	0.55
22	37-7/8	24-3/4	26	SS22BT88	0.55
24	40-7/8	26-5/8	28	SS24BT88	0.55

Figure 118

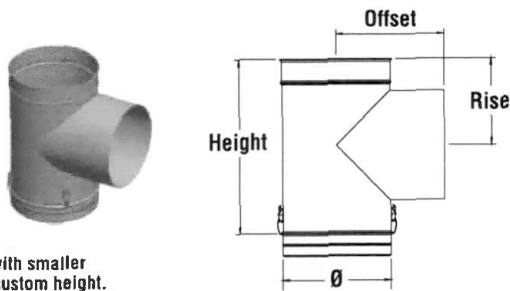

Available with smaller snout and custom height.

SS Barometric Tee					
Ø (in.)	Height (in.)	Offset (in.)	Rise (in.)	Product Code	K Factor
3	11-1/4	5	5-1/2	SS3BMT	0.2
4	11-1/4	5	5-1/2	SS4BMT	0.2
5	12-1/4	5	6	SS5BMT	0.2
6	13-1/4	6	6-1/2	SS6BMT	0.2
7	14-1/4	7	7	SS7BMT	0.2
8	15-1/4	8	7-1/2	SS8BMT	0.2
9	16-1/4	9	8	SS9BMT	0.2
10	17-1/4	10	8-1/2	SS10BMT	0.2
12	19-1/4	12	9-1/2	SS12BMT	0.2
14	21-1/4	14	10-1/2	SS14BMT	0.2
16	23-1/4	16	11-1/2	SS16BMT	0.2
18	25-1/4	18	12-1/2	SS18BMT	0.2
20	27-1/4	20	13-1/2	SS20BMT	0.2
22	29-1/4	22	14-1/2	SS22BMT	0.2
24	31-1/4	24	15-1/2	SS24BMT	0.2

Figure 119

SS VENTING ACCESSORIES

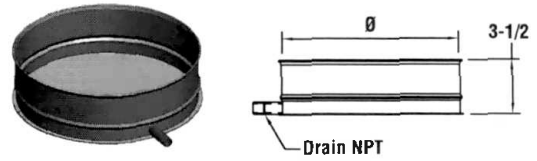

SS Tee Cap		
Ø (in.)	Height (in.)	Product Code
3 to 24	3-1/2	SSØTC

Figure 120

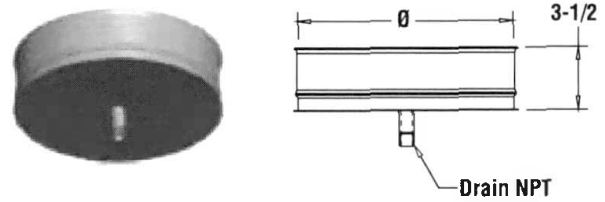

SS Drain Tee Cap		
Ø (in.)	Height (in.)	Product Code
3 to 24	3-1/2	SSØDTC

Drain Ø4 – Ø10, 1/4 NPT, 1/2 O.D.
Drain Ø12 – Ø24, 3/8 NPT, 5/8 O.D.

Figure 121

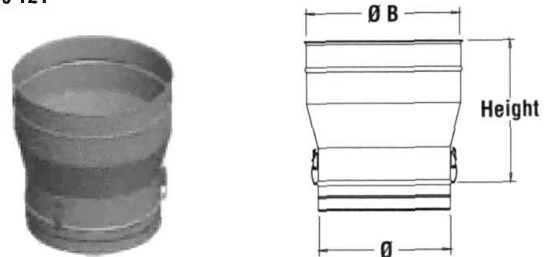

SS Tapered Increaser				
Ø (in.)	ØB Available (in.)	Height (in.)	Product Code	K Factor
3 to 9	Ø+1	11-7/8	SSØTIN(ØB)	0.05
3 to 22	Ø+2	12-7/8	SSØTIN(ØB)	0.10
3 to 9	Ø+3	13-7/8	SSØTIN(ØB)	0.15
3 to 20	Ø+4	14-7/8	SSØTIN(ØB)	0.20
3 to 7	Ø+5	15-7/8	SSØTIN(ØB)	0.25
3 to 18	Ø+6	16-7/8	SSØTIN(ØB)	0.30

Figure 122

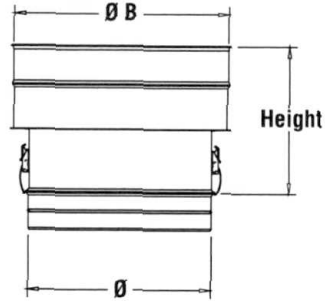

SS Step Increase				
Ø (in.)	ØB Available (in.)	Height (in.)	Product Code	K Factor
3 to 22	5 to 24	10	SSØSIN(ØB)	$KØ = (1-B)^2$ $KØB = KØ/B^4$

Figure 123

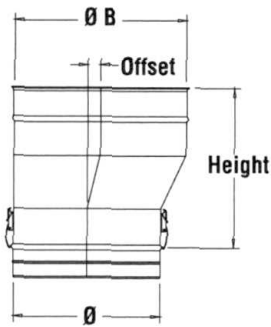

SS Eccentric Tapered Increase					
Ø (in.)	ØB Available (in.)	Height (in.)	Offset (in.)	Product Code	K Factor
3 to 9	Ø+1	12-1/4	1/2	SSØETIN(ØB)	0.05
3 to 22	Ø+2	13-1/4	1	SSØETIN(ØB)	0.10
3 to 9	Ø+3	14-1/4	1-1/2	SSØETIN(ØB)	0.15
3 to 20	Ø+4	15-1/4	2	SSØETIN(ØB)	0.20
3 to 7	Ø+5	16-1/4	2-1/2	SSØETIN(ØB)	0.25
3 to 18	Ø+6	17-1/4	3	SSØETIN(ØB)	0.30

Figure 124

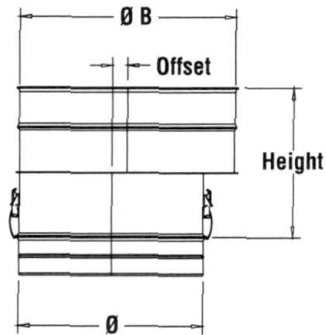

$B = Ø/ØB$

SS Eccentric Step Increase					
Ø (in.)	ØB Available (in.)	Height (in.)	Offset (in.)	Product Code	K Factor
3 to 22	5 to 24	10	$(ØB-ØA)/2$	SSØESIN(ØB)	$KØ = (1-B)^2$ $KØB = KØ/B^4$

Figure 125

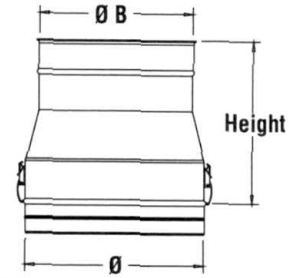

SS Tapered Reducer				
Ø (in.)	ØB Available (in.)	Height (in.)	Product Code	K Factor
5 to 10	Ø-1	11-7/8	SSØTRD(ØB)	0.07
6 to 24	Ø-2	12-7/8	SSØTRD(ØB)	0.09
6 to 12	Ø-3	13-7/8	SSØTRD(ØB)	0.11
8 to 24	Ø-4	14-7/8	SSØTRD(ØB)	0.13
9 to 24	Ø-5	15-7/8	SSØTRD(ØB)	0.15
10 to 24	Ø-6	16-7/8	SSØTRD(ØB)	0.17

Figure 126

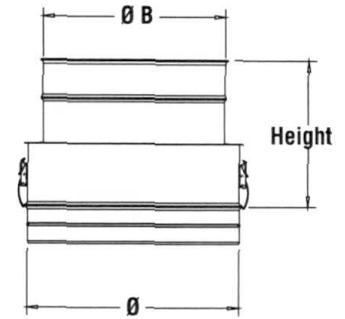

SS Step Reducer				
Ø (in.)	ØB Available (in.)	Height (in.)	Product Code	K Factor
5 to 24	4 to 22	10	SSØSRD(ØB)	$KØ = (1-B)^2$ $KØB = KØ/B^4$

Figure 127

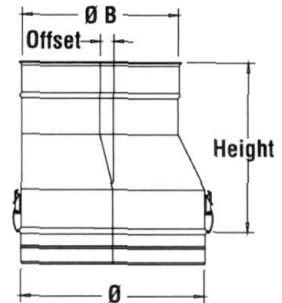

SS Eccentric Tapered Reducer					
Ø (in.)	ØB Available (in.)	Height (in.)	Offset (in.)	Product Code	K Factor
5 to 10	Ø+1	12-1/4	1/2	SSØETRD(ØB)	0.07
6 to 24	Ø+2	13-1/4	1	SSØETRD(ØB)	0.09
6 to 12	Ø+3	14-1/4	1-1/2	SSØETRD(ØB)	0.11
8 to 24	Ø+4	15-1/4	2	SSØETRD(ØB)	0.13
9 to 24	Ø+5	16-1/4	2-1/2	SSØETRD(ØB)	0.15
10 to 24	Ø+6	17-1/4	3	SSØETRD(ØB)	0.17

Figure 128

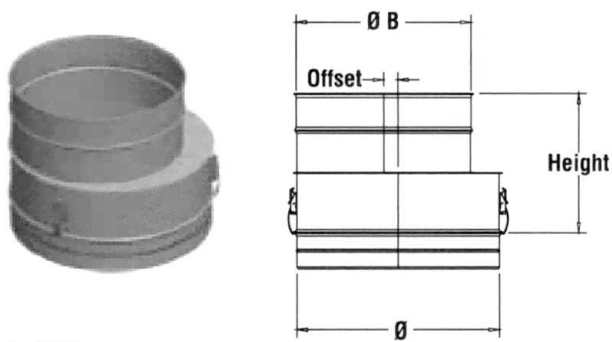

$$B = \frac{\text{Ø}}{\text{ØB}}$$

SS Eccentric Step Reducer					
Ø (in.)	ØB Available (in.)	Height (in.)	Offset (in.)	Product Code	K Factor
5 to 10	4 to 22	10	$(\text{ØA} - \text{ØB})/2$	SSØESRD(ØB)	$K\text{Ø} = (1 - B^2)^2$ $K\text{ØB} = K\text{Ø}/B^4$

Figure 129

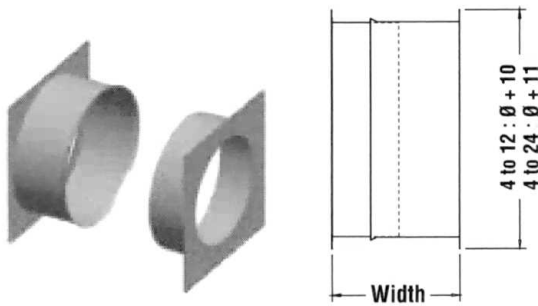

SS Wall Thimble		
Ø (in.)	Height (in.)	Product Code
3 to 24	9 to 17	SSØWT

Figure 130

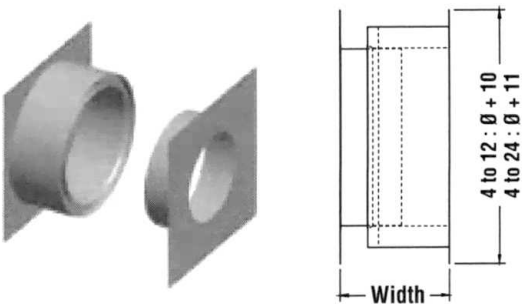

SS Wall Thimble Insulated		
Ø (in.)	Height (in.)	Product Code
3 to 24	9 to 17	SSØWTI

Figure 131

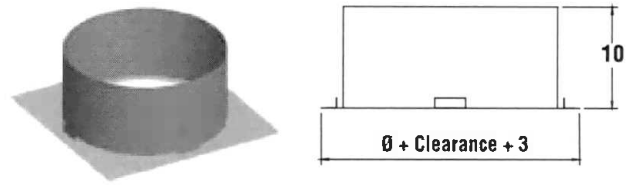

SS Roof Thimble		
Ø (in.)	Height (in.)	Product Code
3 to 24	10	SSØRT

Figure 132

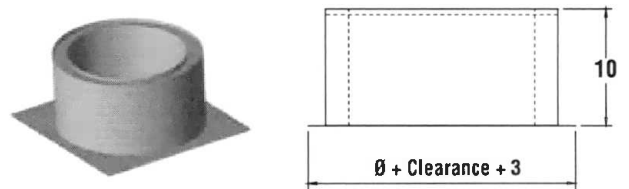

SS Roof Thimble Insulated		
Ø (in.)	Height (in.)	Product Code
3 to 24	10	SSØRTI

Figure 133

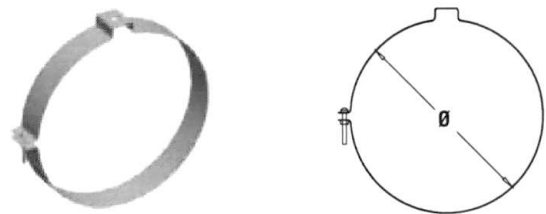

SS Suspension Band	
Ø (in.)	Product Code
3 to 24	SSØSB

Figure 134

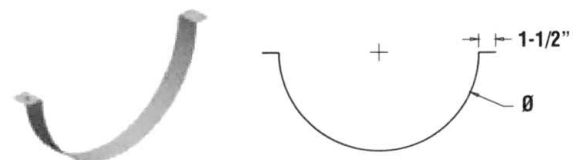

SS Cradle Support	
Ø (in.)	Product Code
3 to 24	SSØCS

Figure 135

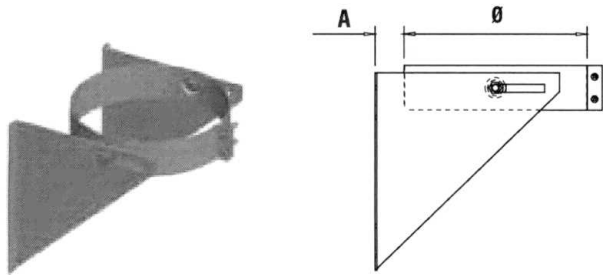

SS Wall Support		
Ø (in.)	Height (in.)	Product Code
3 to 12	2 to 5	SSØWS
14 to 24	4 to 7	SSØWS

Figure 136

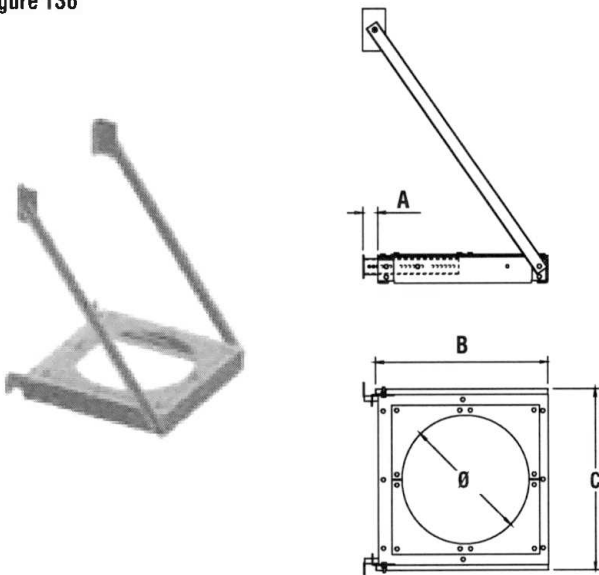

SS Wall Support HD				
Ø (in.)	A (in.)	B (in.)	C (in.)	Product Code
3	2 to 7	7	8	SS3WSD
4	2 to 7	7	8	SS4WSD
5	2 to 7	9	9	SS5WSD
6	2 to 7	12	10	SS6WSD
7	2 to 7	12	11	SS7WSD
8	2 to 7	12	12	SS8WSD
9	2 to 7	14	13	SS9WSD
10	2 to 7	14	14	SS10WSD
12	2 to 7	16	16	SS12WSD
14	4 to 9	22	20	SS14WSD
16	4 to 9	22	22	SS16WSD
18	4 to 9	26	24	SS18WSD
20	4 to 9	26	26	SS20WSD
22	4 to 9	30	28	SS22WSD
24	4 to 9	30	30	SS24WSD

Figure 137

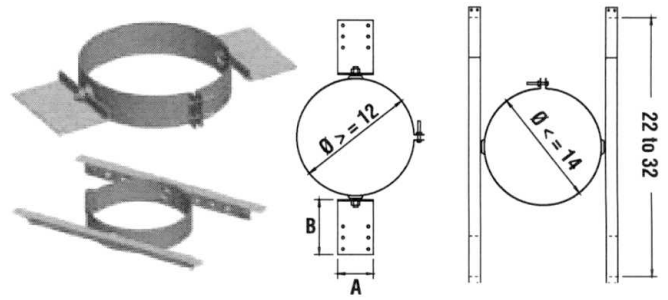

SS Roof Support			
Ø (in.)	A (in.)	B (in.)	Product Code
3 to 12	6-1/2	7-5/8	SSØRS
14 to 24	22 to 32	1-1/2	SSØRS

Figure 138

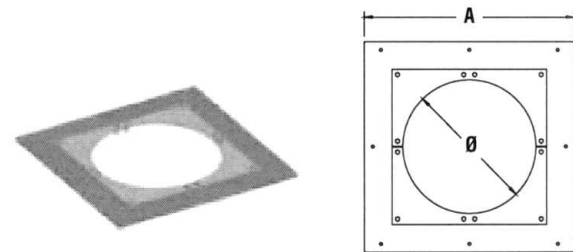

SS Anchor Plate		
Ø (in.)	A (in.)	Product Code
3 to 12	Ø+7	SSØAP
14 to 24	Ø+11	SSØAP

Figure 139

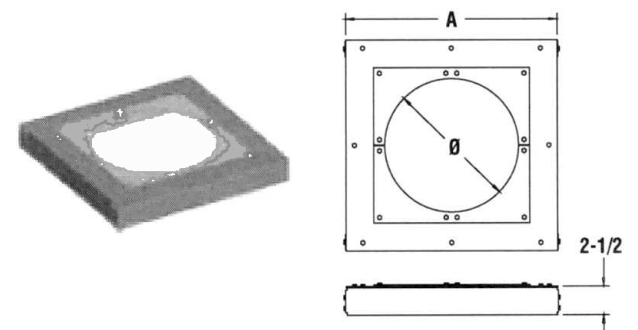

SS Anchor Plate HD		
Ø (in.)	A (in.)	Product Code
3 to 12	Ø+7	SSØAPHD
14 to 24	Ø+11	SSØAPHD

Figure 140

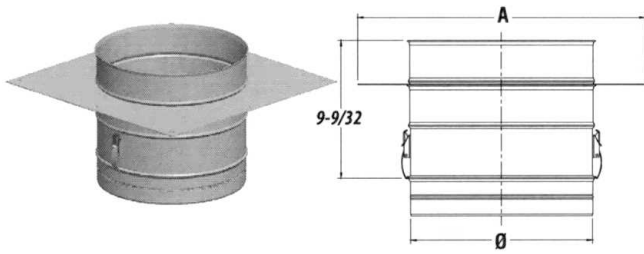

SS Anchor Plate Length (APL)		
\emptyset (in.)	A (in.)	Product Code
3 to 12	$\emptyset + 7$	SS \emptyset APL
14 to 24	$\emptyset + 11$	SS \emptyset APL

Figure 141

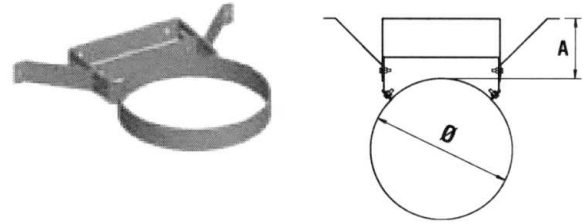

SS Wall Guide		
\emptyset (in.)	A (in.)	Product Code
3 to 24	2 to 5-1/2	SS \emptyset WG
14 to 24	4 to 7-1/2	SS \emptyset WG

Figure 145

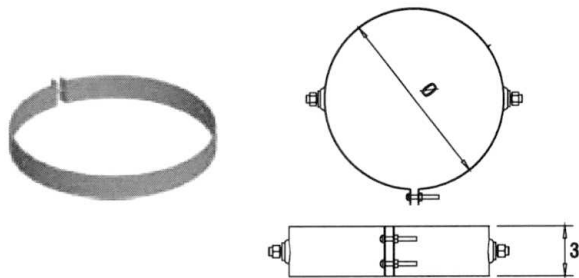

SS Roof Brace	
\emptyset (in.)	Product Code
3 to 24	SS \emptyset RB

Figure 142

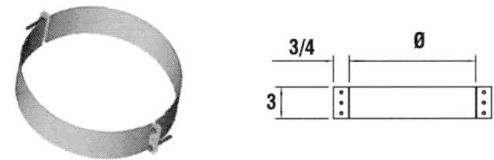

SS Guy Support	
\emptyset (in.)	Product Code
3 to 24	SS \emptyset GS

Figure 146

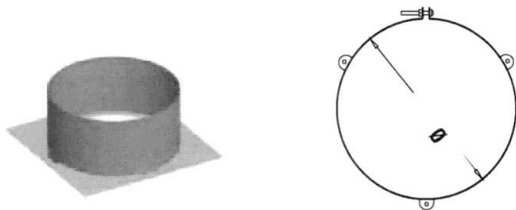

SS Guy Wire Band	
\emptyset (in.)	Product Code
3 to 24	SS \emptyset GWB

Figure 143

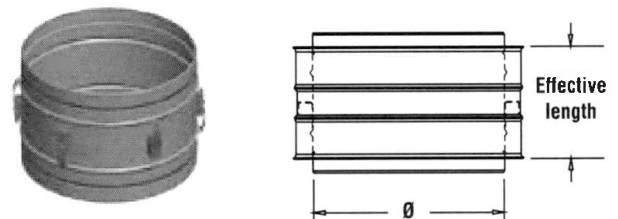

SS Double Male Adaptor		
\emptyset (in.)	Effective Length (in.)	Product Code
3 to 24	3-7/8	SS \emptyset DMA

Figure 147

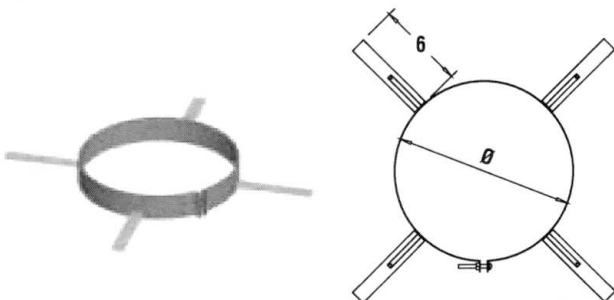

SS Centering Band	
\emptyset (in.)	Product Code
3 to 24	SS \emptyset CB

Figure 144

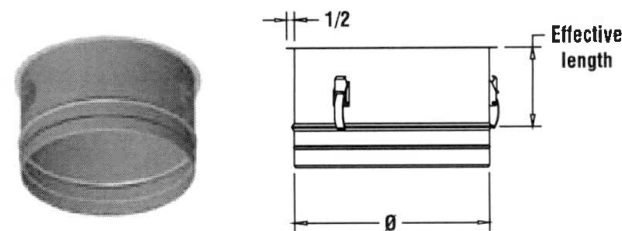

SS Male Flange Adaptor		
\emptyset (in.)	Effective Length (in.)	Product Code
3 to 24	4-7/8	SS \emptyset MFA

Figure 148

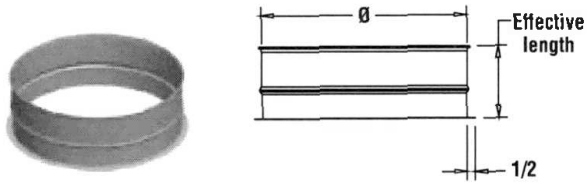

SS Female Flange Adaptor		
Ø (in.)	Effective Length (in.)	Product Code
3 to 24	4-1/4	SSØFFA

Figure 149

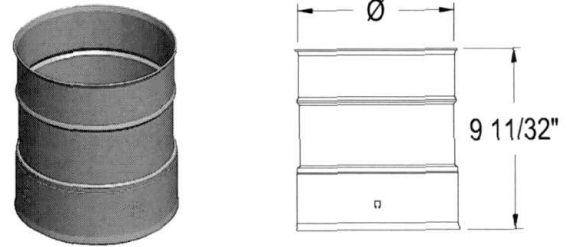

SS Secure-Flex Female Adapter		
Ø (in.)	Effective Length (in.)	Product Code
3 to 12	9-11/32	SSØAFF

Figure 152

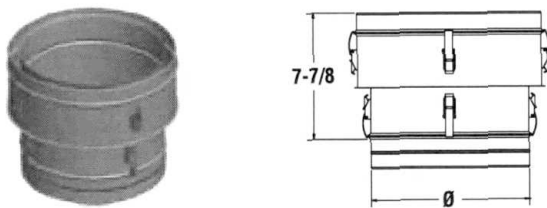

SS to SSD Adaptor		
Ø (in.)	Effective Length (in.)	Product Code
3 to 24	7-7/8	SSØSSDA

Figure 150

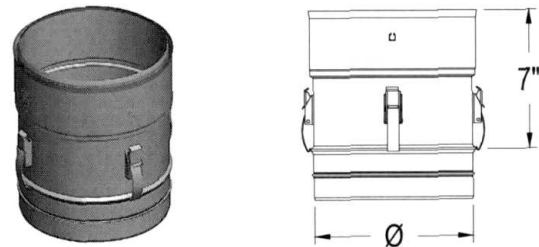

SS Secure-Flex Male Adapter		
Ø (in.)	Effective Length (in.)	Product Code
3 to 12	7	SSØAMF

Figure 153

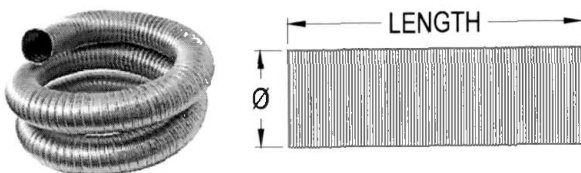

SS Secure-Flex		
Ø (in.)	Flex Length (ft.)	Product Code
3 to 9	20	SSØFLX-20
	25	SSØFLX-25
	30	SSØFLX-30
	35	SSØFLX-35
4	200	SS4FLX-200
5	125	SS5FLX-125
6 & 7	100	SSØFLX-100
8	50	SS8FLX-50
3 to 12	CUSTOM	SSØFLX-XX

Figure 151

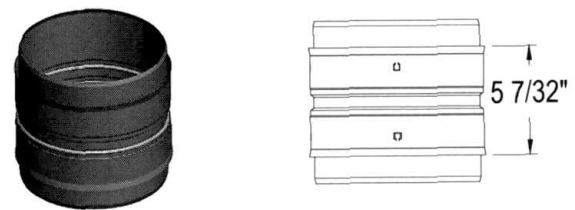

SS Secure-Flex to Secure-Flex		
Ø (in.)	Effective Length (in.)	Product Code
3 to 12	—	SSØAF

Figure 154

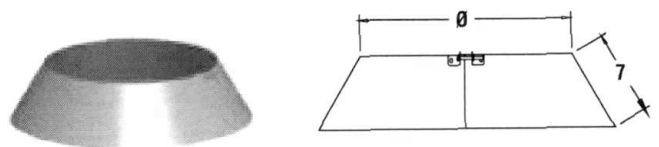

SS Storm Collar		
Ø (in.)	Effective Length (in.)	Product Code
3 to 24	6-1/4	SSØSC

Figure 155

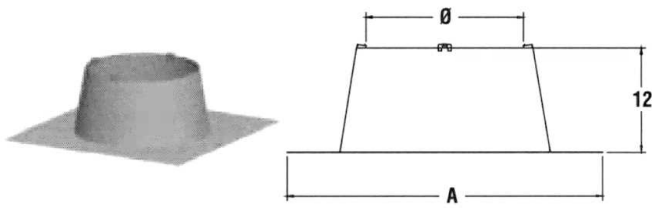

SS Flat Flashing		
\varnothing (in.)	A (in.)	Product Code
3	16	SS3FH
4	16	SS4FH
5	16	SS5FH
6	16	SS6FH
7	18	SS7FH
8	26	SS8FH
9	26	SS9FH
10	28	SS10FH
12	30	SS12FH
14	31	SS14FH
16	34	SS16FH
18	36	SS18FH
20	38	SS20FH
22	40	SS22FH
24	42	SS24FH

Figure 156

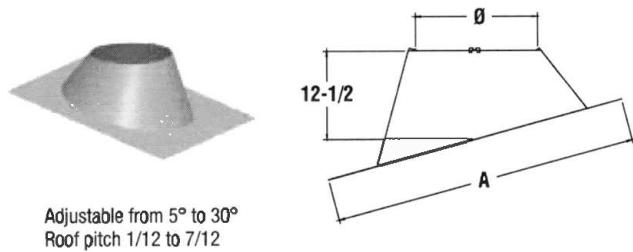

SS Adjustable Flashing			
\varnothing (in.)	A (in.)	Height (in.)	Product Code
3	30	12-1/2	SS3FAH
4	30	12-1/2	SS4FAH
5	30	12-1/2	SS5FAH
6	32	12-1/2	SS6FAH
7	32	12-1/2	SS7FAH
8	34	12-1/2	SS8FAH
9	35-3/8	12-1/2	SS9FAH
10	36-1/2	12-1/2	SS10FAH
12	38-1/2	12-1/2	SS12FAH
14	41	12-1/2	SS14FAH
16	43	12-1/2	SS16FAH
18	45	12-1/2	SS18FAH
20	47-1/4	12-1/2	SS20FAH
22	49-1/2	12-1/2	SS22FAH
24	51-1/2	12-1/2	SS24FAH

Figure 157

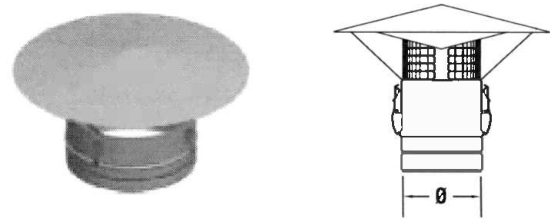

SS Rain Cap			
\varnothing (in.)	Product Code	Product Code with Bird Screen	K Factor
3 to 24	SS3RC	SS \varnothing RCB	.50

Figure 158

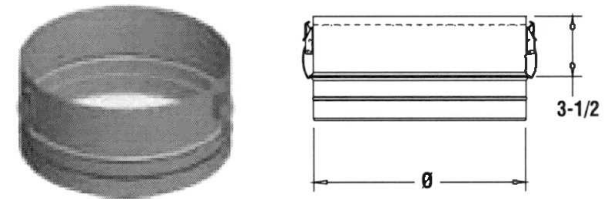

SS Screened Termination		
\varnothing (in.)	Product Code	K Factor
3 to 24	SS \varnothing ST	.14

Figure 159

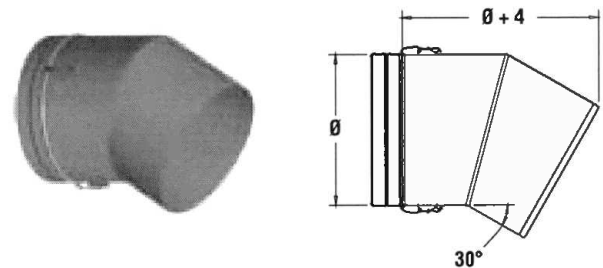

SS 30° Screen Termination		
\varnothing (in.)	Product Code	K Factor
3 to 24	SS \varnothing STA	.70

Figure 160

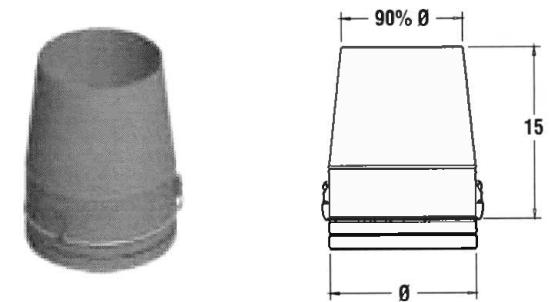

SS Exit Cone		
\varnothing (in.)	Product Code	K Factor
3 to 24	SS \varnothing EC	.60

Figure 161

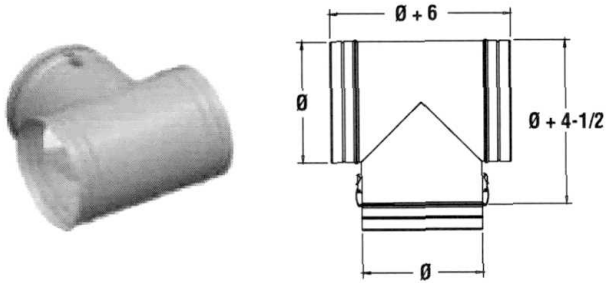

SS Termination Tee		
Ø (in.)	Product Code	K Factor
3 to 24	SSØTT	.35

Figure 162

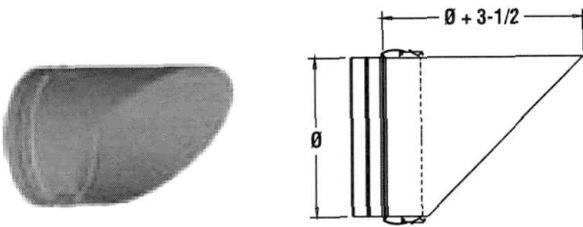

SS Mitre Cut		
Ø (in.)	Product Code	K Factor
3 to 24	SSØMC	.14

Figure 163

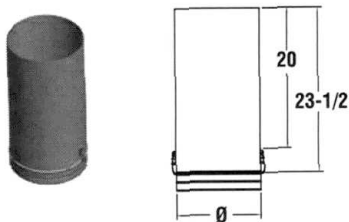

SS DEM Termination		
Ø (in.)	Product Code	K Factor
3 to 24	SSØEMTAU	0

Figure 164

SECURITY CHIMNEYS SECURE SEAL 15 YEAR LIMITED WARRANTY

This Security Chimneys 15-year Limited Warranty warrants your Secure Seal gas vent system (Product) to be free from defects in material and workmanship at the time of manufacture. This 15-year Limited Warranty includes all components and fittings. After installation, if covered components manufactured by Security Chimneys are found to be defective in materials or workmanship during the 15-year Warranty period and while the Product remains at the site of the original installation, Security Chimneys will, at its option, replace the covered components. Security Chimneys reserves the right to replace covered components with an equivalent product and the replacement must be carried out in accordance with Security Chimneys recommendations. If replacement is not commercially practical, Security Chimneys will, at its option, refund the purchase price or wholesale price of the Security Chimneys Product, whichever is applicable. Labor or freight costs to remove or replace Security Chimneys components are not included. THERE ARE EXCLUSIONS AND LIMITATIONS to the 15-year Limited Warranty as described herein.

COVERAGE COMMENCEMENT DATE

Warranty coverage begins on the date of shipment from Security Chimneys to the installation site or project-holding site, whichever is applicable.

EXCLUSIONS AND LIMITATIONS

This 15-year Limited Warranty applies only if the Product is installed in the United States or Canada and only if used for the application for which it was designed and intended. The Product must be installed and maintained in accordance with the printed instructions accompanying the Product and in compliance with all applicable installation and building codes and good trade practices. Any repaired or replaced product shall be warranted for the duration of time no longer than the remaining or unexpired term of the original warranty. The warranty period is 15 years from the date of installation when used for venting listed, Category I, II, III or IV gas heating equipment or water heaters that specify this type of venting system.

The 15-Year Limited Warranty is extended to the purchaser subject to the following additional conditions:

- The vent system is inspected and maintained annually, beginning one year after the date of installation and continue throughout the warranty period.
- Generally accepted engineering practices have been followed to determine that sizing and material specifications are suitable for the application and environment involved.
- The components have been correctly installed in accordance with the system design and installation instructions as provided by Security Chimneys.

This warranty is non-transferable and extends to the original owner only. The Product must be purchased through an Security Chimneys Agent/ Representative and proof of purchase must be provided.

Security Chimneys will not be responsible for: (a) damages caused by normal wear and tear, corrosion from salt air, accident, riot, fire, flood or acts of God, (b) damages caused by abuse, negligence, misuse, or unauthorized alteration or repair of the Product affecting its stability or performance, (c) damages caused by failing to provide proper maintenance and service in accordance with the instructions provided with the Product, (d) damages, repairs or inefficiency resulting from faulty installation or application of the Product.

This 15-year Limited Warranty covers only parts as provided herein. Security Chimneys' entire liability is limited to the purchase price of this Product. In no case shall Security Chimneys be responsible for materials, components or construction, which are not manufactured or supplied by Security Chimneys or for the labor necessary to install, repair or remove such materials, components or construction. All replacement or repair components will be shipped F.O.B. from the Security Chimneys manufacturing facility.

LIMITATION ON LIABILITY

It is expressly agreed and understood that the sole obligation of Security Chimneys and the purchaser's exclusive remedy under this warranty, under any other warranty, expressed or implied, or in contract, tort or otherwise, shall be limited to replacement, repair, or refund, as specified herein.

In no event shall Security Chimneys be liable for any incidental or consequential damages caused by defects in the Product, whether such damage occurs or is discovered before or after replacement or repair, and whether such damage is caused by Security Chimneys negligence.

Security Chimneys makes no expressed warranties except as stated in this 15-year Limited Warranty. The duration of any implied warranty is limited to the duration of this expressed warranty. No one is authorized to change this 15-year Limited Warranty or to create for Security Chimneys any other obligation or liability in connection with the Product. Some states and provinces do not allow the exclusion or limitation of incidental or consequential damages, so the above limitations or exclusions may not apply to you. The provisions of this 15-year Limited Warranty are in addition to and not a modification of or subtraction from any statutory warranties and other rights and remedies provided by law.

INVESTIGATION OF CLAIMS AGAINST WARRANTY

Security Chimneys reserves the right to investigate any and all claims against this 1-Year Standard and 15-year Limited Warranty and to decide, in its sole discretion, upon the method of settlement.

Security Chimneys shall in no event be responsible for any warranty work done by a contractor that is not approved without first obtaining Security Chimneys' prior written consent.

HOW TO REGISTER A CLAIM AGAINST WARRANTY

In order for any claim under this warranty to be valid, you must contact the Security Chimneys Agent/Representative from which you purchased the Product. If you cannot contact the Agent/Representative, then you must notify Security Chimneys in writing. Security Chimneys must be notified of the claimed defect in writing within 90 days of the date of failure. Notices should be directed to the Security Chimneys Warranty Department.

WARRANTY

This product has a 15 year limited warranty. Please read the warranty to be familiar with its coverage.

Retain this manual. File it with your other documents for future reference.

PRODUCT REFERENCE INFORMATION

Please contact Security Chimneys International for the phone number of your nearest Security Chimneys International dealer who will answer your questions or address your concerns.

Normally, all parts should be ordered through your Security Chimneys International distributor or dealer. Parts will be shipped at prevailing prices at time of order.

When ordering repair parts, always give the following information

1. The model number of the vent system.
2. The part number.
3. The description of the part.
4. The quantity required.
5. The installation date of the chimney system.

If you encounter any problems or have any questions concerning the installation or application of this system, please contact your dealer.



2125 MONTEREY ST. • LAVAL, QC., CANADA • H7L 3T6
800-667-3387; www.securitychimneys.com

Security Chimneys International Limited reserves the right to make changes at any time, without notice, in design, materials, specifications, prices
Consult your local distributor for chimney system code information.

© 2011, 2017 Security Chimneys International, Ltd

P/N SFSS REV. 11 08-07-19

RESOLUTION NO. 22-176

A RESOLUTION AUTHORIZING A CONTRACT FOR PROFESSIONAL SERVICES WITH LONG BUILDING TECHNOLOGIES, INC., FOR CONSTRUCTION SERVICES FOR THE FORD WYOMING CENTER FLUE REPLACEMENT, PROJECT NO. 22-058.

WHEREAS, the City of Casper desires to remove and replace the existing boiler flue for the Ford Wyoming Center Flue Replacement, Project No. 22-058.; and,

WHEREAS, Long Building Technologies, Inc., is able and willing to provide those professional services.

NOW, THEREFORE, BE IT RESOLVED BY THE GOVERNING BODY OF THE CITY OF CASPER, WYOMING: That the Mayor is hereby authorized and directed to execute, and the City Clerk to attest, a Contract for Professional Services with Long Building Technologies, Inc., in the amount of One Hundred Twenty-Nine Thousand Nine Hundred Sixty and 00/100 Dollars (\$129,960.00) for services more specifically delineated in the Contract.

BE IT FURTHER RESOLVED: That the City Manager is hereby authorized to make verified partial payments and contract extensions, using appropriate funds, throughout the project as prescribed by the agreement, for a total amount not to exceed One Hundred Twenty-Nine Thousand Nine Hundred Sixty and 00/100 Dollars (\$129,960.00).

PASSED, APPROVED, AND ADOPTED this ____ day of _____, 2022.

APPROVED AS TO FORM:



ATTEST:

Fleur Tremel
City Clerk

CITY OF CASPER, WYOMING
A Municipal Corporation

Ray Pacheco
Mayor

September 19, 2022

MEMO TO: J. Carter Napier, City Manager *JCN*
FROM: Andrew Beamer, P.E., Public Services Director
Alex Sveda, P.E., City Engineer
SUBJECT: Approval of a License Agreement with the Natrona County Board of County Commissioners for sanitary sewer main work.

Meeting Type & Date
Regular Council Meeting
October 4, 2022

Action Type
Resolution

Recommendation:
That Council, by resolution, execute a License Agreement with the Natrona County Board of County Commissioners for sanitary sewer main work within Natrona County.

Summary:
A permit to construct was issued for a 250-foot extension of 8-inch sanitary sewer main to service Lot 1 and Lot 2 (4321 West 40th Street) of The Dens Subdivision on a portion of Wolf Creek Road, owned by Natrona County. The work was completed in August 2022 and requires a License Agreement with Natrona County for the City to maintain and operate the sanitary sewer main within the Natrona County right-of-way.

Financial Considerations
None

Oversight/Project Responsibility
Alex Sveda, City Engineer

Attachments
Resolution
License Agreement with the Natrona County Board of Count Commissioners

APPROVAL AS TO FORM

I have reviewed the attached *License* regarding placing a Sanitary Sewer Main in Wolf Creek Road, and approve it as to form on behalf of the City of Casper, Wyoming.

Dated: September 28, 2022.

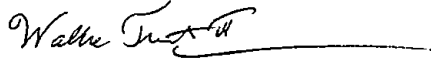

Wallace Trembath III
Deputy City Attorney

LICENSE

Date 9/8/22 Road Wolf Creek Road (#501)

The BOARD OF COUNTY COMMISSIONERS OF THE COUNTY OF NATRONA, STATE OF WYOMING, (hereinafter called the "Board", hereby grants a license to City of Casper, Wyoming

(hereinafter called the "Licensee"), to construct, maintain, use and operate Sanitary Sewer Main (hereinafter called the "Facility"), located in Section 24 Township 33N N, Range 80W, upon the property of the County of Natrona, acquired for and utilized in the operation and maintenance of a county road in the locations and positions and in strict accordance with the specifications shown on the print dated _____, attached hereto, marked Exhibit "A", and by this reference specifically made a part hereof.

This license is granted upon such express terms and conditions as are inserted below, and should the Licensee at any time violate any of the said terms or conditions herein contained or use or attempt to use said facility for any other or different purpose than that above specified, or refuse or fail to comply with any rule or direction of the County Road and Bridge Superintendent, made by said Superintendent under his general supervisory powers of control and supervision of county roads for the use and safety of the general public, then the Board may, at its option, immediately revoke this license.

This license is subject to the following conditions:

FIRST. The work of constructing, altering and maintaining of the Facilities shall be prosecuted and completed in a good and workmanlike manner at the sole expense of the Licensee and under supervision of, and to satisfactorily meet the specifications of the County Road and Bridge Superintendent. Such work of construction, alteration and maintenance of the Facility shall be done in such a manner as to in no way interfere with the use, operation and maintenance by the County of Natrona of a county road for county road purposes, and in such manner as to in no way endanger the general public in use of said county road right-of-way.

SECOND. The said Licensee shall give to the Board, through the County Road & Bridge Superintendent, at least ten days notice, in writing, before entering upon the county road right-of-way for the purpose of construction or alteration of the Facility or to make necessary repairs, except in case of genuine emergency requiring immediate repair, then in that event, the Licensee shall notify the Board, through the County Road & Bridge Superintendent, or local maintenance authority immediately enter upon the county road right-of-way and make necessary repairs. Licensee shall be responsible for any repairs necessary to road or right-of-way for 180 days after completion of construction.

THIRD. The said Licensee agrees to forever indemnify and defend the Board, their agents or employees, against and save them harmless from all liability for damage to property or injury to or death of persons, including all costs and expenses incident hereto, arising wholly or in part from or in connection with the existence of, construction, alteration, maintenance, repair, renewal, reconstruction, operation, use or removal of the said Facility as it pertains to county road property.

FOURTH. The Board reserves the right to use, occupy and enjoy its right-of-way for a county road and for county road purposes, in such manner and at such times as it shall desire, the same as if the instrument had not been executed by it. If any such use shall at any time necessitate any change in the location or manner of use of said Facility, or any part thereof, such change or alteration shall be made by the Licensee, at the sole expense of said Licensee, upon the demand of the Board, through the County Road & Bridge Superintendent, and neither the Board nor the County of Natrona shall be liable to the said Licensee on account thereof, or on account of any damage growing out of any use which the County of Natrona or the Board, or either of them, may make of its said right-of-way.

FIFTH. The Board shall have the right at any time to revoke this license by the giving of thirty (30) days notice in writing to the said Licensee, and at the expiration of the time limited by said notice, or upon the express revocation of this license for any of the causes enumerated herein, the Licensee shall promptly and in the manner directed by the Board, through the County Road & Bridge Superintendent, remove said Facility and each and every part thereof, hereby authorized, from the premises of the county road right-of-way and leave said premises in the same condition in which they were before the installation of said Facility. Upon the refusal or failure of the Licensee to do so, the Board may remove the Facility and each and every part thereof and restore the county road right-of-way to the same condition as before the granting of this license, and the Licensee hereby agrees promptly to pay to the County of Natrona the cost of said removal of the Facilities, and each and every part thereof.

SIXTH. The County of Natrona and the Board, for the purpose of this Licensee, hereby disclaims any representation or implication that it retains any title in any county road right-of-way other than a perpetual easement for road purposes for so much land as described by the instrument conveying such easement. The Licensee by these present accepts notice and agrees that any expenses or damages incurred by said Licensee as a result of this disclaimer shall be borne by said Licensee at no expense whatsoever to the Board or the County of Natrona. It shall be also understood that on Access Facility Highways, Egress and egress shall be limited to those locations as designated by the Board, or their Designated Representative, and shown on plans on file in the office of the County Road Department and County Surveyor.

SEVENTH. The waiver of any breach of any of the terms or conditions of this Licensee shall be limited to the act or acts constituting such breach, and shall never be construed as being a continuing or permanent waiver of any such term or condition, all of which shall be and remain in full force and effect, as to the future acts or happenings, notwithstanding any such individual waiver or any breach thereof.

EIGHTH. The said Licensee agrees to locate underground facilities when needed by the County or other users for future construction and maintenance activities. This location information will include the marking of the facility on the ground, as specified by W.S. §37-12-301 et seq. with the appropriate color and indicating the nature and elevation of the utility and shall be laid both horizontally and vertically, by coordinates, by a licensed land surveyor to a public land survey corner. This information shall be shown on plans created by the utility company or facility owner and a copy will be sent to the Natrona County Surveyor's Office in Casper, Wyoming. Costs for identifying and locating the facility will be the responsibility of the utility company or facility owner on County right-of-ways.

No official or employee of the County of Natrona, other than the Board of County Commissioners, shall have authority to waive any term or condition herein contained. Any amendments to this license agreement shall be in writing, signed by the licensee and designated representative of the county commissioners.

Date of Commencement: 8/16/2022
(Five (5) day notice must be given County Road & Bridge Superintendent before start of construction)

Date of Completion: 8/20/2022
(County Road & Bridge Superintendent must be notified within five (5) days after construction)

IN WITNESS WHEREOF The Board of County Commissioners, has caused this license to be executed on the _____ day of _____, A.D., 19 _____.

COUNTY OF NATRONA

By _____
Road & Bridge Superintendent

By _____
County Surveyor

ATTEST:

County Clerk

By _____
Chairman of the Board of County Commissioners

The undersigned, the Licensee mentioned in the foregoing License, hereby accepts the same, subject to the terms and conditions contained therein.

ATTEST:

Secretary

President

(the original instrument must be recorded in the County Clerk's office by Licensee)

ORIGINAL - RECORDING FILE, YELLOW - COMMISSIONERS, PINK - COUNTY SURVEYOR, GOLDENROD - LICENSEE

PROJECT DOCUMENTS

FOR

**WOLF CREEK ROAD
SEWER LINE**

RECORD DRAWINGS

CONSTRUCTION: AUGUST 2022
CONTRACTOR: 200M CONSTRUCTION

THESE RECORD DRAWINGS HAVE BEEN PREPARED BASED UPON INFORMATION FURNISHED IN PART BY OTHERS. WHILE THIS INFORMATION IS BELIEVED TO BE RELIABLE, CEPI CANNOT ASSURE ITS ACCURACY, AND IS NOT RESPONSIBLE FOR THE ACCURACY OF THESE RECORD DRAWINGS OR FOR ANY ERROR OR OMISSION WHICH MAY HAVE BEEN INCORPORATED INTO THEM AS A RESULT. THOSE RELYING ON THESE RECORD DRAWINGS ARE ADVISED TO OBTAIN INDEPENDENT VERIFICATION OF THEIR ACCURACY BEFORE APPLYING IT FOR ANY PURPOSE.

RECORD DRAWING
PROJECT NO. 21-033
AUGUST, 2022



Civil Engineering Professionals, Inc.
6080 Enterprise Drive, Casper, WY 82609
Phone 307.266.4346 Fax 307.266.0103
www.cepi-casper.com

FOR INFORMATION ON THIS PROJECT:
CIVIL ENGINEERING PROFESSIONALS, INC.
6080 ENTERPRISE DR. CASPER, WYOMING 82609
PHONE 1-307-266-4346 • FAX 1-307-266-0103
PROJECT MANAGER ROB BENNETT - x621



RC OURDAHL
4311 W. 43TH STREET
CASPER, WYOMING 82604

M:\Land 2021\Engineering\21-033 Wolf Creek Rd Sewer Line\21-033 - SEWER PLAN AND PROFILE.dwg, B/28/2022, Austin, Luers

M:\Users\2021\Engineering\21-033-Wolf Creek Rd Sewer Line\21-033 - SEWER PLAN AND PROFILE.dwg, 6/21/2021, Austin, Luebke

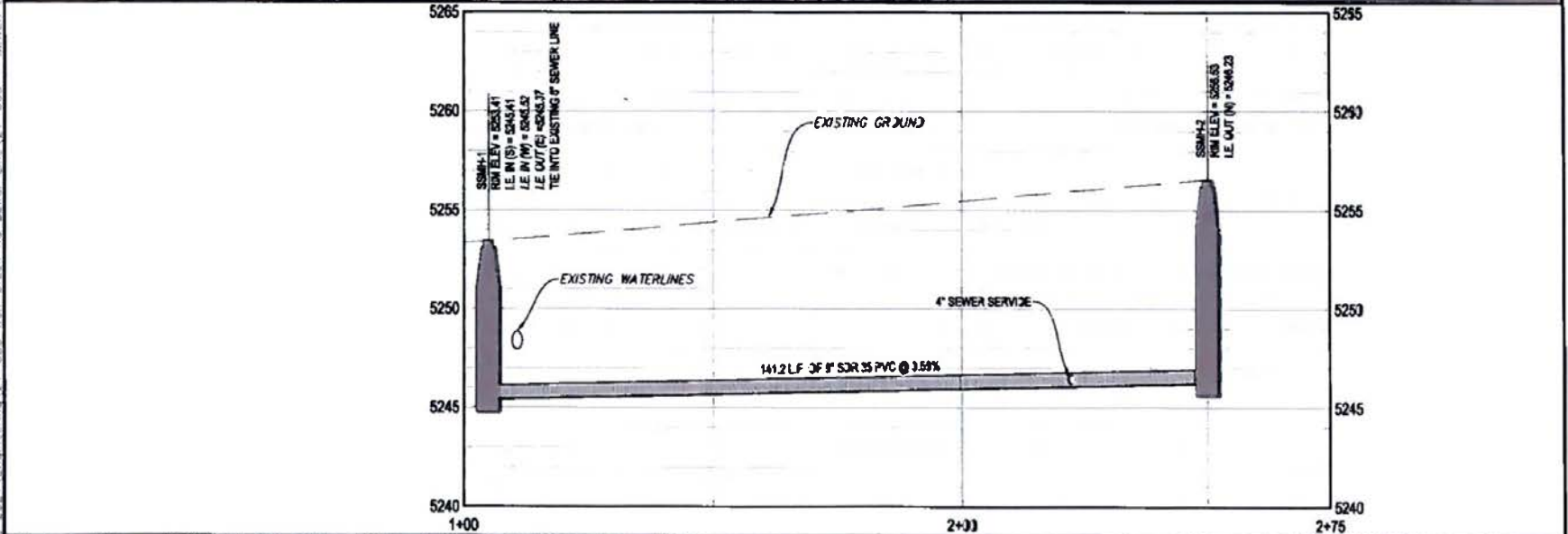

DATE	BY	CHECKED BY	APPROVED BY	PROJECT	SHEET
08/22	AL	BF	BF	WOLF CREEK ROAD SEWER LINE	3
08/22		08/22	08/22	SEWER - P & P - 1+00 TO 2+75	3

CEPI Civil Engineering Professionals, Inc.
 RIC DURDAHL
 CASPER WYOMING

RESOLUTION NO. 22-177

A RESOLUTION AUTHORIZING THE EXECUTION OF A LICENSE AGREEMENT WITH THE NATRONA COUNTY BOARD OF COMMISSIONERS FOR SANITARY SEWER MAIN WORK.

WHEREAS, the property owner at 4341 West 40th Street desires to connect City-owned sanitary sewer main to service their property; and,

WHEREAS, the Natrona County Board of Commissioners requires the City of Casper to execute a License Agreement for the work.

NOW, THEREFORE, BE IT RESOLVED BY THE GOVERNING BODY OF THE CITY OF CASPER, WYOMING: That the Mayor is hereby authorized and directed to execute a License Agreement with the Board of Natrona County Board of Commissioners.

BE IT FURTHER RESOLVED: That the City Manager, Public Services Director, and the City Engineer for the City of Casper, are hereby designated as the authorized representatives of the City of Casper, to act on behalf of the Governing Body on all matters relating to this License Agreement.

PASSED, APPROVED, AND ADOPTED this ____ day of _____, 2022.

APPROVED AS TO FORM:

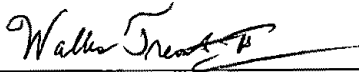

ATTEST:

CITY OF CASPER, WYOMING
A Municipal Corporation

Fleur Tremel
City Clerk

Ray Pacheco
Mayor

September 22, 2022

MEMO TO: J. Carter Napier, City Manager 

FROM: Zulima Lopez, Parks, Recreation, & Public Facilities Director
Adam Hiatt, Network Engineer

SUBJECT: That Council, by Resolution, approve Contract Amendment No. 1 with Dynamic Controls Incorporated, in the Amount of Fifty-Five Thousand Six Hundred Eighty-Nine Dollars (\$55,689), to Purchase and Install Access Control on Select Doors at the Ford Wyoming Center.

Meeting Type & Date

Regular Meeting
October 4, 2022

Action type

Resolution

Recommendation

That Council, by Resolution, approve Contract Amendment No. 1 with Dynamic Controls Incorporated, in the amount of Fifty-Five Thousand Six Hundred Eighty-Nine Dollars (\$55,689). This amendment reduces the scope and cost of the original Professional Services Agreement for the purchase and installation of access control on select doors at the Ford Wyoming Center.

Summary

City of Casper and Ford Wyoming Center (FWC) staff recognized the need to improve security at the facility through door access control. To help facilitate a project, a Wyoming Department of Homeland Security grant was sought. On February 15, 2022 the Casper City Council authorized the acceptance of the Wyoming Department of Homeland Security State Homeland Security Program (SHSP) Grant in the amount of Sixty-Two Thousand One Hundred Ninety-Five Dollars and Eleven Cents (\$62,195.11) to purchase and install a door access control system for the FWC.

A Request for Proposals was issued to solicit door access control solutions and on August 2, 2022, the City Council awarded a Contract for Professional Services to Dynamic Controls Incorporated for the project. The scope of work included the installation and configuration of access control on every door in several entryways, with a few entrances that included 8-12 doors each. The amount of the Contract was Eighty-Six Thousand Six Hundred Thirty Dollars (\$86,630).

Additional funding could not be secured to cover the difference between the Contract award and the SHSP Grant award. Moreover, it was recognized that the purchase of a badge printer and ID badge cards to utilize with the door controls would also be needed, and funding was not readily available to cover that expense. In order for the project cost to fall within the available project

funding and to be able to purchase the necessary equipment, the contractor and staff agreed that reducing access control to only one door within large banks of doors was needed. This reduction in scope would still achieve the desired security improvements, while significantly reducing the cost of the project. Dynamic Controls Incorporated submitted an updated proposal for consideration. City of Casper and Ford Wyoming Center staff wish to move forward with an amendment that reflects the reductions proposed.

Financial Considerations

Amendment No. 1 reduces the Contract amount from Eighty-Six Thousand Six Hundred Thirty Dollars (\$86,630) to Fifty-Five Thousand Six Hundred Eighty-Nine Dollars (\$55,689). The reduction puts the project within budget and leaves enough funding available for the purchase of ID badges and a badge printer.

Oversight/Project Responsibility

Adam Hiatt, Network Engineer, Support Services Department

Attachments

Amendment

Resolution

**AMENDMENT NO. 1 TO THE CONTRACT
FOR PROFESSIONAL SERVICES (“AMENDMENT”)**

This Amendment to the Contract for Professional Services (“Amendment”) is entered into on this ____ day of October, 2022, by and between the following parties:

1. The City of Casper of Casper, Wyoming (“City”), a Wyoming municipal corporation, 200 North David Street, Casper, Wyoming 82601.
2. Dynamic Controls Incorporated (“Contractor”), 7426 6 WN Road, Casper, Wyoming, 82604.

Throughout this document, the City and the Contractor may be collectively referred to as the “parties.”

RECITALS

A. On August 2, 2022, the City and Contractor entered into a *Contract for Professional Services* (“Contract”) for the installation and programming of access control to doors at the Ford Wyoming Center located at 1 Events Drive, Casper, Wyoming 82601.

B. The City of Casper desires to modify the scope of services to reduce the project cost within budget.

C. The Contractor has provided a proposal to reduce the scope of services that is agreeable to both parties.

NOW, THEREFORE, in consideration of the mutual promises and covenants contained herein, the parties hereto agree by and between them to amend the Contract as follows:

1. INCORPORATION OF RECITALS

The recitals set forth above are hereby incorporated herein at this point as if fully set forth as part of this Amendment.

2. AMENDMENT TO PART 1 – AGREEMENT, SECTION 1 – SCOPE OF SERVICES AND SECTION 3 – COMPENSATION AND ADDITION OF EXHIBIT B.

- A. Part 1 Section 1.A. which begins with “All locations of network closets and doors are shown in Exhibit Attached,” is deleted in its entirety and replaced with the following:

“All locations of network closets and doors are shown in Exhibits A and B, which are attached and hereby made part of this Contract.”

- B. Part 1 Section 1.B. which begins with “The north entrance shall have access control configured and installed on eight doors.” is deleted in its entirety and replaced with the following:

“The north entrance shall have access control configured and installed on one door. The Contractor shall install one card reader to control the door.”

- C. Part 1 Section 1.C. which begins with “The west entrance shall have access control configured and installed on twelve doors.” is deleted in its entirety and replaced with the following:

“The west entrance shall have access control configured and installed on one door. The Contractor shall install one card reader to control the door.”

- D. Part 1 Section 3. paragraph which begins with “In consideration of the performance of services rendered under this Contract,” is deleted in its entirety and replaced with the following paragraph:

“In consideration of the performance of services rendered under this Contract, the Contractor shall be compensated for services performed in accordance with paragraph 1, not to exceed a sum of Fifty-Five Thousand Six Hundred Eighty-Nine Dollars (\$55,689).”

3. RATIFICATION

The terms and conditions of the Contract, as modified herein, are hereby ratified by the parties and shall remain in full force and effect.

IN WITNESS WHEREOF, the undersigned duly authorized representatives of the Parties have executed this Amendment as of the day and year above.

APPROVED AS TO FORM

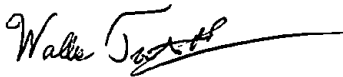

ATTEST

CITY OF CASPER, WYOMING
A Municipal Corporation

Fleur Tremel
City Clerk

Ray Pacheco
Mayor

WITNESS

CONTRACTOR
Dynamic Controls Incorporated

By: _____

By: *DB*

Printed Name: _____

Printed Name: DAVE BRYAN

Title: _____

Title: PROJECT ENGINEER



RESOLUTION NO. 22-178

A RESOLUTION AUTHORIZING AMENDMENT NO. 1 TO THE CONTRACT FOR PROFESSIONAL SERVICES WITH DYNAMIC CONTROLS INCORPORATED FOR INSTALLATION AND PROGRAMMING OF ACCESS CONTROL ON SELECT DOORS AT THE FORD WYOMING CENTER.

WHEREAS, On February 15, 2022 the Casper City Council authorized the acceptance of the Wyoming Department of Homeland Security State Homeland Security Program (SHSP) Grant in the amount of \$62,195.11 to purchase and install an access control system for the Ford Wyoming Center; and,

WHEREAS, On August 2, 2022, the City of Casper and Dynamic Controls Incorporated entered into a Contract for Professional Services for the installation and programming of an access control system for the Ford Wyoming Center in the amount of \$86,630; and,

WHEREAS, Additional funding for the project has not been secured and the City of Casper desires to modify the scope of services to reduce the project cost within the amount awarded by Homeland Security; and,

WHEREAS, Dynamic Controls Incorporated and the City of Casper have agreed to a reduced scope and cost as set forth in Amendment No. 1 of the Contract for Professional Services.

NOW, THEREFORE, BE IT RESOLVED BY THE GOVERNING BODY OF THE CITY OF CASPER, WYOMING: That the Mayor is hereby authorized and directed to execute, and the City Clerk to attest, the above described Amendment No. 1 to the Contract for Professional Services with Dynamic Controls Incorporated for the installation and programming of access control to select doors at the Ford Wyoming Center.

PASSED, APPROVED, AND ADOPTED this ____ day of _____, 2022.

APPROVED AS TO FORM:



ATTEST:

CITY OF CASPER, WYOMING
A Municipal Corporation

Fleur Tremel
City Clerk

Ray Pacheco
Mayor

September 22, 2022

MEMO TO: City Council
J. Carter Napier, City Manager *JCN*

FROM: John Henley, City Attorney *AH*
Heather Bender, Paralegal

SUBJECT: Release of Local Assessment District (LAD) lien – 1818 Fetterman Ave,
Casper, Wyoming 82604

Meeting Type & Date

Regular Council Meeting
October 4, 2022

Action type

Resolution

Recommendation

That Council, by resolution, authorize the release of an LAD Lien and execution of a *Partial Release of Lien* and *Notice of Satisfaction of Agreement and Promissory Note*. The property for which the lien should be released is 1818 Fetterman Ave., Casper, Wyoming 82604.

Summary

Find attached a resolution authorizing the release of a local assessment district lien which has been paid by the owner, as well a *Partial Release of Lien* and *Notice of Satisfaction of Agreement and Promissory Note*.

Financial Considerations

The City recovered \$5,180.46

Oversight/Project Responsibility

John Henley, City Attorney
Jill Johnson, Financial Services Director

Attachments

Resolution
Partial Release of Lien
Notice of Satisfaction of Agreement and Promissory Note

PARTIAL RELEASE OF LIEN

The City of Casper, Wyoming, a Wyoming municipal corporation, 200 North David Street, Casper, Wyoming 82601, completed Local Assessment District 156, which improved real property owned by Xing You Liu and Qingzhu Tang located in Casper Wyoming, identified as follows:

LOT 548, WESTWOOD NO. 2, AN ADDITION TO THE CITY OF CASPER, NATRONA COUNTY, WYOMING, AS PER PLAT RECORDED APRIL 27, 1955, IN BOOK 156 OF DEEDS, PAGE 446.

The real property is more commonly known as: 1818 Fetterman Ave., Casper, Wyoming 82604.

The Lien (Final Assessment Roll) recorded with the Natrona County Clerk as *Record No. 901815* on the *6th day of January, 2011*, included 1818 Fetterman Ave., Casper, Wyoming 82604. The lien amount for the property known as 1818 Fetterman Ave, Casper, Wyoming, 82604 has been paid and satisfied in full and in consideration of the payment, the City of Casper does hereby release its Lien which encumbered 1818 Fetterman, Casper, Wyoming more particularly described above.

Please remove the Lien from the property identified above.

APPROVED AS TO FORM:

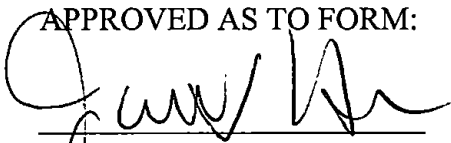

ATTEST:

City of Casper, WYOMING,
A Municipal Corporation

Fleur Tremel
City Clerk

Ray Pacheco
Mayor

State of Wyoming)
)
County of Natrona)

This instrument was acknowledged before me on the ___ day of _____, 2022, by Ray Pacheco, Mayor of the City of Casper, Wyoming.

(seal)

Notary Public

**NOTICE OF SATISFACTION OF AGREEMENT AND
PROMISSORY NOTE**

The City of Casper, Wyoming, a Wyoming municipal corporation, 200 North David Street, Casper, Wyoming 82601 and Xing You Liu and Qingzhu Tang entered into an *Agreement and Promissory Note*, recorded with the Natrona County Clerk as *Instrument No. 1096042* against the real property described as follows:

LOT 548, WESTWOOD NO. 2, AN ADDITION TO THE CITY OF CASPER, NATRONA COUNTY, WYOMING, AS PER PLAT RECORDED APRIL 27, 1955, IN BOOK 156 OF DEEDS, PAGE 446.

The real property is more commonly known as: 1818 Fetterman Ave., Casper, Wyoming 82604

The property owners have fully satisfied the indebtedness described in the Agreement and Promissory Note in full.

APPROVED AS TO FORM:

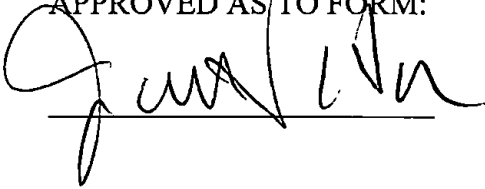

ATTEST:

City of Casper, WYOMING,
A Municipal Corporation

Fleur Tremel
City Clerk

Ray Pacheco
Mayor

State of Wyoming)
)
County of Natrona)

This instrument was acknowledged before me on the ___ day of _____, 2022, by Ray Pacheco, Mayor of the City of Casper, Wyoming.

(Seal)

My Commission Expires:

Notary Public

RESOLUTION NO. 22-179

A RESOLUTION AUTHORIZING A RELEASE OF LOCAL ASSESSMENT DISTRICT (LAD) LIEN, LAD 156, REGARDING 1818 FETTERMAN AVE, CASPER, WYOMING.

WHEREAS, the City of Casper, Wyoming, completed LAD No. 156 which improved various properties, including 1818 Fetterman Ave, Casper, Wyoming 82604; and,

WHEREAS, a Lien (Final Assessment Roll) was recorded with the Natrona County Clerk on January 6, 2011, against various properties, including 1818 Fetterman Ave, Casper, Wyoming 82604; and,

WHEREAS, the City of Casper, and property owners Xing You Liu and Qingzhu Tang, entered into an *Agreement and Promissory Note* which was recorded with the Natrona County Clerk as *Instrument No. 1096042* on January 13, 2021, with respect to *Instrument No. 901815 LAD Assessment Role for Fort Casper Reconstruction - Phase II, recorded on the 6th day of January 2011*. The property owners have paid their assessment in full and have made all payments required by the *Agreement and Promissory Note* satisfactorily, and the same should be released as indicated on the attached *Partial Release of Lien* and *Notice of Satisfaction of Agreement and Promissory Note*.

NOW, THEREFORE, BE IT RESOLVED BY THE GOVERNING BODY OF THE CITY OF CASPER, WYOMING: that the Mayor is hereby authorized to execute, and the City Clerk to attest a *Partial Release of Lien* and the *Notice of Satisfaction of Agreement and Promissory Note* (attached) with respect to 1818 Fetterman Ave, Casper, Wyoming 82604.

PASSED, APPROVED, AND ADOPTED this ___ day of _____, 2022.

APPROVED AS TO FORM:



ATTEST:

CITY OF CASPER, WYOMING
A Municipal Corporation

Fleur Tremel
City Clerk

Ray Pacheco
Mayor

September 23, 2022

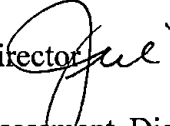
MEMO TO: J. Carter Napier, City Manager 
FROM: Jill Johnson, Financial Services Director 
SUBJECT: Request for release of Local Assessment District Lien regarding Local Assessment District 153 – 1517 Fremont Avenue, Casper, Wyoming

Meeting Type & Date

Regular Council Meeting
October 4, 2022

Action type

Resolution

Recommendation

That City Council, by resolution, authorize the partial release of a local assessment district lien by execution of a *Release of Lien*. The property for which the lien should be released is 1517 Fremont Avenue, Casper, Wyoming.

Summary

The City of Casper completed LAD 153 which improved various properties in the City of Casper. A lien and final assessment roll were recorded with the Natrona County Clerk on June 28, 2002. Financial Services staff reports there is no record of a balance due regarding 1517 Fremont Avenue and the lien regarding that proper should be released.

Find attached a resolution authorizing the release of a Local Assessment District lien regarding 1517 Fremont Avenue, Casper, Wyoming.

Financial Considerations

There are no financial considerations; the account has no balance due.

Oversight/Project Responsibility

Jill Johnson, Financial Services Director
Brandy Coyle, Accounts Receivable Supervisor

Attachments

Resolution
Release of Lien

RELEASE OF LIEN

The City of Casper, Wyoming, a Wyoming municipal corporation, 200 North David Street, Casper, Wyoming 82601, completed Local Assessment District 153, which improved real property owned by David B. Forbes and Maureen P. Forbes, located in Casper Wyoming, identified as follows:

Legal Description: LOT 218, FORT CASPER ADDITION TO THE CITY OF CASPER, NATRONA COUNTY, WYOMING.

More commonly known as: 1517 Fremont Avenue, Casper, Wyoming

The Lien (Final Assessment Roll) recorded with the Natrona County Clerk as *Record No. 0695446* on the *28th day of June, 2002*, has been paid and satisfied in full and in consideration of the payment, the City of Casper does hereby release the Lien. Please remove the Lien from the property identified above.

APPROVED AS TO FORM:

Wallis Tremmel

ATTEST:

City of Casper, WYOMING,
A Municipal Corporation

Fleur Tremel
City Clerk

Ray Pacheco
Mayor

State of Wyoming)
)
County of Natrona)

This instrument was acknowledged before me on the _____ day of _____, 2022, by Ray Pacheco, Mayor of the City of Casper, Wyoming.

(Seal)

My Commission Expires:

Notary Public

RESOLUTION NO. 22-180

A RESOLUTION AUTHORIZING THE RELEASE OF LOCAL ASSESSMENT DISTRICT LIEN 1517 FREMONT AVE, CASPER, WYOMING.

WHEREAS, the City of Casper, Wyoming, completed Local Assessment District (LAD) No. 153, which improved various properties in the City of Casper; and,

WHEREAS, a lien and final assessment roll regarding all of the properties in the assessment district, was recorded with the Natrona County Clerk on the June 28, 2002, as Instrument No. 0695446; and,

WHEREAS, the City of Casper has no record of an assessment balance due regarding 1517 Fremont Avenue, Casper, Wyoming. A Release of Lien regarding the property should be executed and recorded with the Natrona County Clerk.

NOW, THEREFORE, BE IT RESOLED BY THE GOVERNING BODY OF THE CITY OF CASPER, WYOMING: that the Mayor is hereby authorized to execute, and the City Clerk to attest the Release of Lien, releasing the lien against Lot 218, Fort Casper Addition to the City of Casper, Natrona County, Wyoming, more commonly known as 1517 Fremont Avenue, Casper, Wyoming.

PASSED, APPROVED, AND ADOPTED this ___ day of _____, 2022.

APPROVED AS TO FORM:

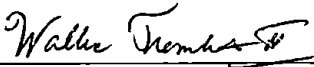

ATTEST:

CITY OF CASPER, WYOMING
A Municipal Corporation

Fleur Tremel
City Clerk

Ray Pacheco
Mayor

September 21, 2022

MEMO TO: J. Carter Napier, City Manager *JCN*
FROM: Keith McPheeters, Chief of Police Chief *KMP 307*
Jeremy Tremel, Lieutenant *JT*
SUBJECT: Memorandum of Understanding between the City of Mills and the City of Casper for Metro Animal Services (Shelter)

Meeting Type & Date

Council Meeting
October 4, 2022

Action type

Resolution

Recommendation

That Council, by resolution, authorizes the Memorandum of Understanding between the City of Mills and the City of Casper for Metro Animal Shelter Services.

Summary

To enhance local partnerships and animal safety, the City of Casper and the City of Mills have agreed to cooperatively facilitate the following:

- The City of Casper is willing to provide certain animal control services in the form of the utilization of its animal holding facility, and the City of Mills desires to acquire those services from the City of Casper.
- The term of this MOU is from September 6, 2022, until June 30, 2024.
- Coordinate, centralize, and economically work together to benefit the citizens of each community.

In exchange for these services, the City of Mills agrees to pay the City of Casper \$2,667.77 each month for the services discussed above.

The number of animals that may be turned over to Metro by the City of Mills each month will be capped at twelve (12) dogs and (5) cats or small animals.

This agreement is a continuation of the agreement authorized by the Council on July 5, 2022, and provides the City of Mills with the services needed to care for animals in their community as they are no longer able to procure services from their usual resource in which to house and care for animals. This agreement will serve as a stop-gap until a more formal contractual user agency agreement can be put in place. This mutual agreement provides for a significantly enhanced local partnership while also providing increased animal safety and welfare.

Financial Considerations

If authorized to enter into the proposed MOU, the City may incur expenses, which would approximate \$400 per month, but will not exceed \$400 per month for veterinary and medical costs.

Oversight/Project Responsibility

Jeremy Tremel, Lieutenant
Casper Police Department Command Staff

Attachments

Memorandum of Understanding between the City of Casper and the City of Mills
Resolution

MEMORANDUM OF UNDERSTANDING
CONCERNING METRO ANIMAL SHELTER SERVICES
BETWEEN
THE CITY OF MILLS, WYOMING
AND
THE CITY OF CASPER, WYOMING AND THE CASPER POLICE DEPARTMENT

This Memorandum of Understanding (MOU) is made and entered this 4th day of October, 2022, with an effective date of September 6, 2022, by and between the City of Mills, Wyoming, a Municipal Corporation, (“**Mills**”), the City of Casper, a Municipal Corporation, (“**Casper**”), via its Casper Police Department (“**CPD**”), and Metro Animal Shelter (“**Metro**”), an entity of the Casper Police Department.

RECITALS

WHEREAS, Mills, in keeping with its ordinances and resolutions, has certain needs to address animal control within its municipal boundaries, including providing for the custody and control of animals that come into its possession through the operation of its ordinances and resolutions; and

WHEREAS, Casper, and the Casper Police Department, by way of Metro Animal Shelter, in keeping with its ordinances and resolutions likewise has certain needs to address animal control within its municipal boundaries, including providing for the custody and control of animals that come into its possession through the operation ordinances and resolutions; and

WHEREAS, Casper, has established an animal holding facility, Metro Animal Shelter, for the housing of animals that come into its possession and control; and

WHEREAS, Mills does not have an animal holding facility for the housing of animals that come into its possession and control; and

WHEREAS, Mills and Casper desire to coordinate, centralize, and economically work together for the benefit of the citizens of each community for animal care and control; and

WHEREAS, Mills and Casper agree to exchange information and maintain communications in order to provide service to their citizens; and

WHEREAS, Casper, for and in exchange for the consideration and covenants set forth in this MOU is willing to provide Mills certain animal control services in the form of the utilization of its animal holding facility, and Mills desires to acquire the same from Casper; and,

WHEREAS, Mills and Casper find it in their interests to extend the arrangement from their previous MOU entered into July 1, 2022, until such time as better data points can be determined to enter into a more permanent arrangement.

NOW THEREFORE, in exchange for the terms, conditions and covenants set forth herein the parties hereto warrant and agree as follows:

TERMS, CONDITIONS, AND COVENANTS

1. Services Provided. The services provided shall include boarding, medical care (subject to Section 5), provision of food, obedience evaluations, safe and sanitary living conditions, outdoor facilities, overall care, monitoring of the animals' wellbeing, use of facilities for deceased animals pursuant to Metro's policies, and, adoption services after the applicable waiting period has passed or court ordered instructions, for all animals that are confiscated by the Mills' Animal Control Office and/or Police Department.
2. Monthly Fees.
 - a) Mills will pay the Casper \$2,667.77 per month for the services discussed in Section 1 for the term described in Section 10 below. Absent exigent circumstances, or a court order, animals arriving at the shelter shall be housed for five (5) business days.
 - b) The number of animals that may be turned over to Metro by Mills in each month of this MOU is capped at twelve (12) dogs and five (5) cats or small animals picked up by animal control officers. Additional animals may be turned over to Metro by mutual agreement at a cost of \$360.00 per animal per month, which shall be the responsibility of Mills, along with Mills paying all veterinary and medical bills.
3. Timing for Reclaiming Animal. Any owner may reclaim their animal or animals any time prior to expiration of the five (5) business day waiting period. Business days are Monday through Saturday, excluding holidays.
4. Collection of Fees. In the event that the animal's owner arrives to reclaim the animal, the fees shall be collected directly from the owner. The fees shall only amount to the number of days the animal was actually in Metro's care. These fees shall solely be the responsibility of the party reclaiming the animal(s). Any fees that are unpaid by the Owner through no fault of Casper (such as an Owner's bounced check, or later dispute of a credit card transaction) shall be paid by Mills to Casper within thirty (30) days of invoicing, and Casper agrees to subrogate its fee claim against the Owner to Mills.
5. Medical Treatment.
 - a) If an animal needs medical treatment during the five (5) business day waiting period, referenced in Section 2, Metro shall, except in the case of a life-or-death emergency of an animal ("emergency"), discuss this with the Animal Control Officer for Mills, and prior to providing any medical treatment, shall receive written authorization from an animal control officer from Mills. An email will suffice for written authorization. In the case of an emergency, Metro shall use its reasonable discretion in deciding whether to provide medical treatment.

- b) The cost/expense of all veterinary services and other medical treatment provided for animals during the five (5) business day waiting period in excess of \$400.00 shall be the responsibility of Mills. Mills is responsible for all other veterinary and medical costs in excess of \$400.00 during each month for all medical care for all animals, not \$400.00 per month for each animal brought to Metro by Mills. Casper shall send an itemized invoice to Mills, and Mills shall pay Casper these fees directly within thirty (30) days of receipt of the invoice.
 - c) Mills shall coordinate with a veterinary service of its choosing prior to entering into this MOU.
6. Surrender of Animal. In the event an animal is not reclaimed during the five (5) business day waiting period, the animal shall be surrendered to Metro and any decisions relating to the disposition of the animal will lie solely with Metro shelter staff. In accordance with Section 5. b., Mills is responsible for the costs of all medical care provided for surrendered animals until the animal leaves Metro's facility.
- a) The five (5) business day waiting period shall not apply to animals housed at Metro which are the subject of a pending court case in the City of Mills Municipal Court. Notwithstanding the foregoing, this provision shall not be used as a mechanism to compel an owner to pick up a citation issued by the Mills Police Department.
7. Court Orders. In the event an animal is ordered by the Municipal Court Judge or Attorneys of the City of Mills to be held at Metro pending the outcome of a citation, or trial, Mills shall be responsible for the housing fees associated with said animal that are incurred by Metro after the five (5) business day waiting period.
- a) Casper shall send an itemized invoice to Mills, and Mills shall pay Casper these fees directly within thirty (30) days of receipt of the invoice.
8. Shelter Access.
- a) During the business hours when Metro is closed to the public, Monday through Friday from 08:00 am to 12:00 pm, and Saturday from 08:00 am to 01:00 pm, and holidays, animals can be brought to Metro after making arrangements with Metro staff by calling 307-920-2917, or such other number as may be provided by Casper to Mills from time to time.
 - b) During business hours when Metro is open to the public, Monday through Friday from 12:00 pm to 5:00 pm, animals can be brought to Metro by coming to the main entrance and contacting Metro shelter staff.
 - c) Shelter access and/or drop-off for animals is not available at any other time than as set forth in this section.
9. Refrigerator Access.

- a) For deceased animals, Mills may use Metro’s refrigerator for up to three (3) days per animal. However, after 3 days at the latest, Mills shall collect the animal for disposal.
10. Liability Insurance. Mills shall keep its liability insurance in place with the Wyoming Local Government Liability Pool or such other local government liability pool as is authorized by Wyoming Statutes. Each party to this MOU shall assume the risk of any liability arising from its own conduct. Neither party agrees to insure, defend, or indemnify the other.
11. Term/Duration. The term of this MOU is from September 6, 2022, until midnight on July 31, 2024.
12. Miscellaneous Provisions.
- a) *Governmental Immunity*. Mills and Casper do not waive any right or rights they may have pursuant to the Wyoming Governmental Claims Act, Wyoming Statutes Section 1-39-101 *et. seq.*, and specifically reserve the right to assert any and all rights, immunities, and defenses they may have pursuant to the Wyoming Governmental Claims Act.
- b) *Amendment*. Either party may request changes to this MOU. Any changes, modifications, revisions or amendments to this MOU which are mutually agreed upon in writing by both parties to the MOU shall be incorporated by written instrument, executed and signed by authorized representatives of both parties.
- c) *Authority*. Individuals signing this MOU on behalf of the Parties agree and represent that they have the legal authority to bind themselves, as representatives of the party to terms of this MOU.
- d) *Assignment*. Neither of the Parties shall assign this MOU or any terms, conditions, rights or obligations herein without the prior written consent of the other.
- e) *Severability*. The Parties agree that if any part, term, or provision of this MOU is held illegal or in conflict with any law of any governmental entity having jurisdiction over the Parties, the validity of the remaining portions or provisions shall not be affected, and the rights and obligations of the Parties shall be construed and enforced as if the MOU did not contain the particular part, term, or provisions held to be invalid, unless the effect thereof would materially change the economic burden of, or benefit to, either party.
- f) *Governing Law and Jurisdiction*. The construction, interpretation and enforcement of this MOU shall be governed by the laws of the State of Wyoming law. The Parties agree that the state courts of the State of Wyoming shall have jurisdiction over any and all actions arising out of this MOU and over the Parties, any filings shall be, and the venue shall be, in the applicable court of the Seventh Judicial District, Natrona County Wyoming.

- g) *Relationship of the Parties.* The Parties do not intend to create in any other individual or entity the status of third-party beneficiary, and this MOU shall not be construed so as to create such status. The rights, duties and obligations contained in this MOU shall operate only between the Parties, and shall inure solely to the benefit of the Parties in determining and performing their obligations under this MOU. The Parties agree that the MOU may be executed at dates and times convenient to the Parties, and that the MOU shall be effective upon the date of the last endorsement necessary to secure a binding MOU, or the “Effective Date,” whichever is later.
- h) *Execution.* This MOU may be executed in counterparts (including by facsimile or e-mailed portable document format file), all of which shall constitute one document, and that by the signature(s) hereto, the undersigned further agree that facsimile or e-mailed portable document format file signatures shall be effective for all purposes, unless original signatures are otherwise required by law.
- i) *Entire Agreement.* This MOU along with its exhibits and referenced documents and/or instruments, supersedes any and all other agreements, either oral or in writing, between the Parties with respect to the subject matter hereof and contains all of the covenants and agreements between the Parties with respect to such matter, and each party to this MOU acknowledges that no representations, inducements, promises or agreements, oral or otherwise, have been made by any party, or anyone acting on behalf of any party, which are not embodied herein, and that no other agreement, statement or promise not contained in this agreement shall be valid or binding.

THOSE SIGNING BELOW CERTIFY THAT THEY HAVE CAREFULLY AND COMPLETELY READ THE FOREGOING, THAT THEY UNDERSTAND THE TERMS AND CONDITIONS SET FORTH HEREIN AND THAT ON BEHALF OF THEMSELVES AND THEIR AGENCY (IF APPLICABLE) THEY AGREE TO ABIDE BY SUCH TERMS AND CONDITIONS.

The remainder of this page is intentionally left blank

Signature Page for the City of Mills

APPROVED AS TO FORM
(Attorney for the City of Mills)

DocuSigned by:

DFCE038067BA43A...

CITY OF MILLS, WYOMING

DocuSigned by:

B4B97B9A9B0B455

Seth Coleman
Mayor

Christine Trumbell
City Clerk

Signature Page for the City of Casper

APPROVED AS TO FORM
(Attorney for the City of Casper)

DocuSigned by:

711E56C840E24B1...

CITY OF CASPER, WYOMING

ATTEST:

Ray Pacheco
Mayor

Fleur Tremel
City Clerk

RESOLUTION NO. 22-181

A RESOLUTION AUTHORIZING A MEMORANDUM OF UNDERSTANDING CONCERNING METRO ANIMAL SHELTER SERVICES BETWEEN CITY OF MILLS, WYOMING, AND THE CITY OF CASPER, WYOMING.

WHEREAS, the City of Casper, by way of Metro Animal Shelter, in keeping with its ordinances and resolutions have certain needs to address animal control within its municipal boundaries, including providing for the custody and control of animals that come into its possession through the operation of its ordinances and resolutions; and,

WHEREAS, the City of Casper, has established an animal holding facility, Metro Animal Shelter, for the housing of animals that come into its possession; and,

WHEREAS, the City of Mills does not have an animal holding facility for the housing of animals that come into its possession and control; and,

WHEREAS, the City of Casper and the City of Mills desire to coordinate, centralize, and work together for the benefit of the citizens of each community for animal sheltering; and,

WHEREAS, the parties desire to enter into a Memorandum of Understanding.

NOW, THEREFORE, BE IT RESOLVED BY THE GOVERNING BODY OF THE CITY OF CASPER, WYOMING: That the Mayor is hereby authorized and directed to execute, and the City Clerk to attest, a Memorandum of Understanding Concerning Animal Shelter Services between the City of Mills, Wyoming, and the City of Casper, Wyoming, in the amount delineated in the Memorandum of Understanding.

PASSED, APPROVED, AND ADOPTED on this ___ day of _____, 2022.

APPROVED AS TO FORM:



ATTEST:

CITY OF CASPER, WYOMING
A Municipal Corporation

Fleur D. Tremel
City Clerk

Ray Pacheco
Mayor

September 14, 2022

MEMO TO: J. Carter Napier, City Manager *JCN*

FROM: Zulima Lopez, Parks, Recreation, & Public Facilities Director
Randy Norvelle, Parks Manager

SUBJECT: Authorizing a Memorandum of Understanding Between the City of Casper and Natrona County Library for the Installation of a StoryWalk

Meeting Type & Date

Regular Meeting
October 4, 2022

Action type

Resolution

Recommendation

That Council, by Resolution, approves a Memorandum of Understanding (MOU) with the Natrona County Public Library for the installation and maintenance of a StoryWalk and related improvements on a section of the Platte River trail adjacent to Crossroads Park.

Summary

In April 2022, the Natrona County Library contacted the Platte River Trails Trust (PRTT) regarding the installation of a StoryWalk along the river trail. The PRTT engaged the City of Casper, and after careful consideration, the three groups agreed that the Platte River Trail adjacent to Crossroads Park would be a good place to locate the StoryWalk. The location is adjacent to a park and easily accessible, and the path is wide and straight enough to limit conflicts with bicyclists and other trail users.

A StoryWalk allows children and families to enjoy reading and outdoor spaces at the same time. It is comprised of stands placed along a trail approximately twenty (20) feet apart. Each stand contains a page from a children's picture book, which is read as the reader walks along the trail. This would be the first StoryWalk in Natrona County.

A Memorandum of Understanding (MOU) is needed to memorialize the partnership for the StoryWalk between the City of Casper, as the owner of the trail property, and the Natrona County Public Library, who will install and maintain the StoryWalk and related infrastructure, including signage as approved by the City of Casper. The terms of the MOU require the Library to inspect the StoryWalk a minimum of once per month and address any replacements and repairs to the book pages and structures, including removal of graffiti. The City of Casper will have no liability related to the StoryWalk, or responsibility to maintain any part of the amenity, but may remove components as needed if determined to be unsafe or unsightly due to disrepair. The City retains

the right to remove the StoryWalk in its entirety if it is not properly maintained, with any associated costs borne by the Library.

Financial Considerations

There is no anticipated cost to the City related to the StoryWalk.

Oversight/Project Responsibility

Randy Norvelle, Parks Manager

Attachments

Resolution

Memorandum of Understanding

MEMORANDUM OF UNDERSTANDING

THIS MEMORANDUM OF UNDERSTANDING (MOU), entered into on this _____ day of _____, 2022, by and between the City of Casper ("City"), a Municipal Corporation, 200 North David Street, Casper, Wyoming 82601, and the Natrona County Library ("Library"), 307 E. 2nd Street, Casper, Wyoming 82601.

RECITALS

- A. The City is the owner of real property generally described as the Platte River Trail and Crossroads Park located at 1101 N. Poplar St., Casper, Wyoming 82601 and grants permission to the Library to put in place a StoryWalk® along the Platte River Trail.
- B. The Library desires to construct a StoryWalk® and necessary improvements on a section of the Platte River Trail adjacent to Crossroads Park located at 1101 N. Poplar St., Casper, Wyoming 82601 as show on Exhibit A.
- C. The Library shall ensure that the installation of the StoryWalk® meets or exceeds all American Society for Testing and Materials (ASTM) standards for safety and functionality; is installed in accordance with manufacturer's written recommendations; and meets all the requirements of the Casper Municipal Code.
- D. The City agrees to allow the Library to place the StoryWalk® subject to the terms and conditions of this MOU.

NOW, THEREFORE, in consideration of the covenants and conditions set forth herein to be performed, the Parties agree as follows:

- 1. Incorporation of Recitals. The recitals set forth above are hereby incorporated herein at this point as if fully set forth as part of this MOU.
- 2. Purpose. The purpose of this MOU is to establish installation requirements and maintenance responsibilities for a StoryWalk® along the Platte River Trail at Crossroads Park.

3. Installation.

- a. The Library shall construct the StoryWalk® in accordance with the documents listed below.
 - i. StoryWalk® Solutions Aluminum Frame with Aluminum Post-Angled attached hereto as Exhibit B. This meets or exceeds City of Casper Standard Specifications for Public Works Construction and Infrastructure Improvements Section 640.04 Fence Construction.
 - ii. StoryWalk® Solutions Picture Book Displays Post Installation Guidance attached hereto as Exhibit C.
- b. Each post of the StoryWalk® shall be placed no less than six (6) feet from the eastern edge of the Platte River Trail. There will be twenty-four (24) posts total, placed in locations as shown on Exhibit A.
- c. East post of the StoryWalk® shall be placed in a concrete pad in compliance with all applicable safety and functionality standards and subject to approval of the City of Casper.
- d. The StoryWalk® shall meet all Americans with Disabilities Act (ADA) standards.

4. Maintenance.

- a. The Library will inspect the StoryWalk® area a minimum of one (1) time per month for loose or missing story pages. The Library shall replace all missing or damaged pages.
- b. The Library shall maintain the structures to include repairs, theft, and removal of graffiti.
- c. The City shall not be held liable for any damage to the StoryWalk® posts or concrete during City maintenance activities.
- d. The City, at its sole discretion, may remove story pages it deems unsightly due to damage or wear. The City will inform the Library that pages have been removed and need replaced.

- e. The City is under no obligation to repair or replace any StoryWalk® feature.
- f. The City retains the right to remove StoryWalk® features due to disrepair. The Library will replace, at the Library's expense, any StoryWalk® feature the City removes due to disrepair.
- g. The City retains the right to remove the StoryWalk® in its entirety if not properly maintained. The City will get two good faith estimates to return the property to its prior condition and the Library will have fifteen (15) days to pay the least expensive, responsible option.

5. Recognition Sign.

- a. The Library may place a recognition sign provided that the sign is subordinate to, and in keeping with, the character of the StoryWalk® and Platte River Trail.
- b. Signage design shall be pre-approved by the Parks, Recreation, and Public Facilities Director prior to ordering and must be in accordance with City Resolution 19-195, Provisions and Procedures for Accepting Donations, Memorials, and Sponsorship Contributions. The Parks, Recreation, and Public Facilities Director may reject any design that does not meet City donation standards.
- c. Signage will be purchased and maintained by the Library. The Library will be responsible for repair or replacement of the sign due to vandalism or other damage. The City is under no obligation to repair or replace recognition signage.
- d. The City may temporarily remove signage it deems unsightly or unsafe due to damage. The Library may reinstall a repaired sign or replace it with a new sign of the same approved design.
- e. In recognition of their donation to the City, the Library may place their logo on the sign.
- f. Signage may not utilize any other corporate logos or slogans than Natrona County Library. Corporate names may be used.

6. Agreement Term.

- a. The term of the “Installation” portion of this MOU shall commence on the date written above, and shall remain in full force and effect until the installation work is acceptable and approved by the City Engineer. However, the installation shall be completed by the Library no later than November 15, 2022.
- b. The term of the “Maintenance” and “Recognition Signage” portions of this MOU shall commence on the date written above, and shall remain in full force and effect until this MOU is terminated by either Party.

7. Agreement Termination. After construction of the StoryWalk®, either Party may terminate the MOU by giving thirty (30) days written notice to the other Party of its intent to terminate this MOU. Upon termination, the City will get two good faith estimates to return the property to its prior condition and the Library will have fifteen (15) days to pay the least expensive, responsible option. Recognition signage will also be removed at the Library’s expense from the area.

8. Insurance.

- a. The Library shall keep in place its existing insurance through the Wyoming Association of Risk Management (“WARM”) or another policy that is substantially similar throughout the duration of this MOU and for at least five (5) years thereafter.
- b. Installation. During the installation, the Library will ensure all contractors involved in the project have automobile, builders’ risk, and commercial general liability insurance naming the City of Casper as additional insured with at least \$250,000/\$500,000 limits. Said insurance shall remain in effect through the contractors’ labor and installation periods. Workers’ compensation shall also be provided by the contractors in statutory amounts prior to and at the time of the installation and acceptance of the StoryWalk®.

9. Miscellaneous Provisions.

- a. Governmental Claims. The Parties do not waive any right or rights they may have pursuant to the Wyoming Governmental Claims Act, Wyoming Statutes Section 1-39-1010 et seq., and

the Parties specifically reserve the right to assert any and all rights, immunities, and defenses they may have pursuant to the Wyoming Governmental Claims Act.

b. Third Party Beneficiary.

- i. Except for as described in section c. ii. Below, the Parties to this MOU do not intend to create, except as provided above in any other individual or entity the status of third-party beneficiary, and this MOU shall not be construed so as to create such status. Except as provided above, the rights, duties, and obligations contained in this MOU shall operate only between the signatories to this MOU, and shall inure solely to the benefit of the Parties to this MOU. The signatories to this MOU intend and expressly agree that only signatories to this MOU shall have any legal or equitable right to seek to enforce this MOU, to seek any remedy arising out of a Party's performance or failure to perform any term or condition of this MOU, or to bring an action for the breach of this MOU.
 - ii. Notwithstanding Section c. i. above, the City shall be deemed a third party beneficiary of the material and construction contracts of the StoryWalk®, including warranties thereof.
- c. Incorporation of Exhibits. All exhibits referenced herein are hereby made a part of this MOU.
- d. Authority. Each individual executing this MOU, for and on behalf of the Parties, hereby state that they have the requisite power and authority to enter into this MOU and to consummate the transactions contemplated and intended hereby.
- e. Complete MOU. This MOU shall constitute the entire understanding and agreement of the Parties, and no amendment or modification of the terms of this MOU shall be valid or enforceable unless made in writing and executed by all Parties hereto.
- f. Merger. The Parties specifically agree that all prior agreements between them, oral or written, regarding the StoryWalk® are hereby contained, set forth and merged in this MOU.

- g. Binding. This MOU shall be binding upon the Parties hereto, and their respective successors, heirs, grantees and assigns.
- h. Notices. Any and all notices required to be made under the terms of this MOU shall be made by mailing said notice to the other Party at the other Party's address as stated below, or at such other address specified in writing by any Party to the other Parties by United States First Class, Certified Mail, Return Receipt Requested:

Natrona County Library:
 Natrona County Library
 Attn: Lisa Scroggins
 307 E. 2nd St.
 Casper, WY 82601

City:
 City of Casper
 Attn: City Manager
 200 N. David St.
 Casper, WY 82601

- i. Recording. The Parties agree that this MOU shall be recorded in the real estate records of Natrona County, Wyoming at the sole cost of the City.
- j. Survival. The provisions of Section 8 (Insurance and Indemnification) of this MOU and remedies for the breach thereof, shall survive the termination of this MOU under the terms hereof for a period of three (3) years beyond the termination or expiration hereof unless otherwise stated in the MOU. In addition, all other provisions that logically ought to survive termination of this MOU shall survive.

k. Electronic Signatures.

The Parties understand and agree that they have the right to execute this MOU through paper or through electronic signature technology, which is in compliance with Wyoming and federal law governing electronic signatures. The Parties agree that to the extent they sign electronically, their electronic signature is the legally binding equivalent to their handwritten signature. Whenever they execute an electronic signature, it has the same validity and meaning as their handwritten signature. They will not, at any time in the future, repudiate the meaning of their electronic signature or claim that their electronic signature is not legally binding. They agree not to object to the admissibility of this MOU as an electronic record, or a paper copy of an electronic document, or a paper copy of a document bearing an electronic

signature, on the grounds that it is an electronic record or electronic signature or that it is not in its original form or is not an original. Each Party will immediately request that their electronic signature be revoked in writing if they discover or suspect that it has been or is in danger of being lost, disclosed, compromised or subjected to unauthorized use in any way. If either Party would like a paper copy of this MOU, they may request a copy from the other Party, and the other Party shall provide it.

IN WITNESS WHEREOF, the undersigned duly authorized representatives of the Parties have executed this MOU as of the day and year above.

APPROVED AS TO FORM:

Walker Tremel

NATRONA COUNTY LIBRARY

CITY OF CASPER, WYOMING
A Municipal Corporation

Lisa Scroggins
Lisa Scroggins
Executive Director

Ray Pacheco
Mayor

Dated this 28 day of Sept. 2022.

Dated this ____ day of _____ 2022.

WITNESS:

ATTEST

By: Randy Marvella
Printed Name: Randy Marvella
Title: Parks Manager

By: _____
Fleur Tremel

EXHIBIT A

Story Walk Locations

RIVERSIDE MOBILE HOME COURT LLC

CITY OF CASPER

Object	Latitude	Longitude
1	42° 51' 41.24" N	106° 19' 43.66" W
2	42° 51' 41.07" N	106° 19' 43.66" W
3	42° 51' 40.87" N	106° 19' 43.63" W
4	42° 51' 40.30" N	106° 19' 43.49" W
5	42° 51' 40.11" N	106° 19' 43.40" W
6	42° 51' 39.96" N	106° 19' 43.30" W
7	42° 51' 39.72" N	106° 19' 43.17" W
8	42° 51' 39.49" N	106° 19' 42.99" W
9	42° 51' 39.26" N	106° 19' 42.95" W
10	42° 51' 39.07" N	106° 19' 42.97" W
11	42° 51' 38.86" N	106° 19' 43.05" W
12	42° 51' 38.64" N	106° 19' 43.11" W
13	42° 51' 38.46" N	106° 19' 43.14" W
14	42° 51' 38.25" N	106° 19' 43.12" W
15	42° 51' 38.04" N	106° 19' 43.09" W
16	42° 51' 37.82" N	106° 19' 43.06" W
17	42° 51' 37.64" N	106° 19' 42.99" W
18	42° 51' 37.45" N	106° 19' 42.89" W
19	42° 51' 37.14" N	106° 19' 42.71" W
20	42° 51' 36.89" N	106° 19' 42.62" W
21	42° 51' 36.67" N	106° 19' 42.62" W
22	42° 51' 36.49" N	106° 19' 42.62" W
23	42° 51' 36.37" N	106° 19' 42.49" W
24	42° 51' 36.33" N	106° 19' 42.21" W

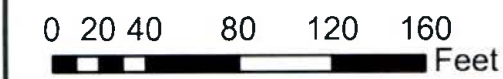



StoryWalk® Solutions

ALUMINUM FRAME with ALUMINUM POST-ANGLED

- Designed for an 18”H x 24”W page, with a viewable area of 17”H x 23”W
- 45 Degree display angle
- Standard post length of 60” for in-ground installation
 - Longer post lengths available
 - Surface mount aluminum posts available
- Removable bottom rail for easy page insertion
- Two sheets of acrylic protect the laminated page
- 3 Year Warranty on the powder-coated aluminum frame and post.
- Made in the USA

SIGN PANEL MOUNTS
28-32" FROM GRADE



Prepare footing depth per recommendations for your geographic region. Ensure that post is plumb and level while back-filling with appropriate materials. The pre-drilled thru holes at post-end allows for insertion of 1/2" diameter x 8" long piece of rebar for added security.

Assembly Instructions:

1. Attach the frame to the post plate using the provided hardware and allen driver. You will need a 7/16" socket wrench to install the nylock nut. DO NOT use power tools as the stainless hardware may gall and seize.
2. Remove the 2 screws from the bottom frame rail with the provided allen driver.
3. Insert the acrylic sheets and replace the bottom rail.

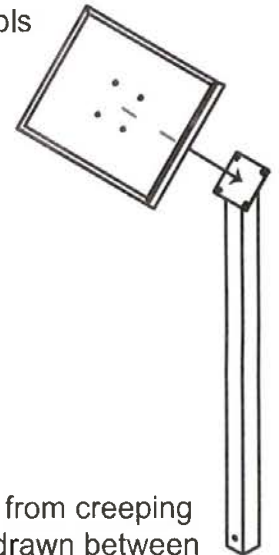

Page Installation Instructions - First time

1. Remove the bottom frame rail using the provided allen driver
2. Remove the blue masking from both sides of the acrylic sheets.
3. Place your page and optional colored backer between the sheets of acrylic.
4. Slide the sheets into the frame bottom.
5. Replace the bottom rail.

Moisture Issue? Add 2 or 3 Clip Spacers to the bottom of your page to minimize water from creeping up between the acrylic sheets. It creates a larger gap; therefore, moisture will not be drawn between the sheets as easily. Clip spacers are small, plastic paper clips that are sold under the brand Plastiklips LP-0200.



Cleaning Instructions:

- Use a soft cloth and a diluted soap & water solution to wash the display.
- Dry the display with a soft cloth.
- DO NOT USE ammonia cleaners (Windex) or paper towels as they may damage the acrylic.

StoryWalk® Solutions
PICTURE BOOK DISPLAYS
POST INSTALLATION GUIDANCE
BARKING DOG EXHIBITS



FINISHED HEIGHT IS 30" FROM GRADE - ADJUST AS NEEDED

Post installation (no concrete):

1. Dig an 8" diameter hole 36" deep. Refer to your area's recommendations for below grade installations.
2. Fill hole with 14.-15" of compacting gravel, center post in hole, compact gravel around the post frequently. To increase security, put a length of 1/2" rebar thru the hole in the post.
3. Check for plumb and level while compacting.
4. Finish the last 4" with soil.

Post installation with concrete:

1. Repeat #1 - 3 above.
2. Follow directions on the bag of fast set concrete for quantity.
3. Be sure to check for plumb and level, support display while concrete is setting

The StoryWalk® Story

The StoryWalk® is an innovative and delightful way for children — and adults! — to enjoy reading and the outdoors at the same time. Laminated pages from a children's book are installed along an outdoor path. As you walk the path you are directed to the next page in the story. The StoryWalk® Project was created by Anne Ferguson of Montpelier, VT and developed in collaboration with the Kellogg-Hubbard Library. Storywalk® is a registered service mark owned by Ms. Ferguson."

NOTE

If installing posts without frames attached (recommended), the height to the **center** of the 60" long wood or aluminum post is approx 37.5" for 30" from grade display height.

bdexhibits.com (715) 214-5862
storywalk@bdexhibits.com ruth@bdexhibits.com

RESOLUTION NO. 22-182

A RESOLUTION ESTABLISHING A MEMORANDUM OF UNDERSTANDING BETWEEN THE CITY OF CASPER AND NATRONA COUNTY LIBRARY FOR A STORYWALK®

WHEREAS, the City of Casper is the owner of the Platte River Trail as a part of North Platte Park; and,

WHEREAS, the City of Casper has established criteria for allowing Natrona County Library to construct and maintain a StoryWalk®; and,

WHEREAS, Natrona County Library is ready, willing, and able to construct and maintain a StoryWalk® along the Platte River Trail as part of North Platte Park; and,

WHEREAS, the City of Casper desires to enter into a Memorandum of Understanding (MOU) with Natrona County Library to construct and maintain a StoryWalk® to the general public.

NOW, THEREFORE, BE IT RESOLVED BY THE GOVERNING BODY OF THE CITY OF CASPER, WYOMING: That the Mayor is hereby authorized and directed to execute, and the City Clerk to attest, the Memorandum of Understanding (MOU) with Natrona County Library for the construction and maintenance of the StoryWalk® as described in the MOU.

PASSED, APPROVED, AND ADOPTED this ____ day of _____, 2022.

APPROVED AS TO FORM:

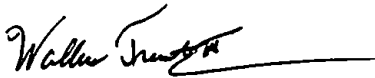

ATTEST:

CITY OF CASPER, WYOMING
A Municipal Corporation

Fleur Tremel
City Clerk

Ray Pacheco
Mayor

September 23, 2022

MEMO TO: J. Carter Napier, City Manager 
City Council

FROM: John Henley, City Attorney 
Wallace Trembath, III, Deputy City Attorney *W. T.*

SUBJECT: A Resolution Authorizing a Ground Lease Agreement between the City of Casper and WYO Complex, a Wyoming non-profit corporation.

Meeting Type & Date
Regular Council Meeting
October 4, 2022

Action type
Resolution

Recommendation
That City Council approve a Ground Lease Agreement between the City of Casper and WYO Complex, a Wyoming non-profit corporation.

Summary
The City of Casper was approached by WYO Complex, a non-profit entity that wants to construct an indoor sports and events complex in close proximity to the Ford Wyoming Center. The land that WYO Complex proposes to construct their facility on is City-owned. If approved by City Council, the land would be leased to WYO Complex by the City. City staff have been working with WYO Complex and its attorney on a long-term Ground Lease Agreement.

City Staff believes leasing the property to WYO Complex for the purpose of constructing a multi-million-dollar facility for sports and educational activities will further community and economic development of the City of Casper and the surrounding communities. The lease of the land to construct the facility would:

- Increase the number of visitors to the City, bringing the revenue associated therewith.
- Allow large regional tournaments and educational events to be hosted in Casper.
- Increase the availability of court and turf space for youth sports which boosts the physical and mental health of the communities' youth.
- Create a space and entity for coordination of events with the Ford Wyoming Center to draw more events to the City.

Some of the key terms of the Ground Lease Agreement are:

- **Term.** The term of the proposed Ground Lease Agreement is 99 years.
- **Rent.** The Base Rent under the proposed lease is \$1.00 per annum, however, the Tenant (WYO Complex) would pay as Additional Rent all expenses of every kind and nature

whatsoever relating to or arising from the Premises, including all expenses arising from the leasing, operation, management, construction, maintenance, repair, use, and occupancy of the Premises, except as otherwise expressly provided in the Lease.

- **Facility.** The Facility is in the design stage. WYO Complex handles the entire cost of constructing the Facility, and it expects the value of the Facility to be in the range of tens of millions of dollars when completed. Prior to starting construction, WYO Complex will provide the City with preliminary design documents and the construction documents, identifying and describing the materials, signage, design, and architectural 3-D renderings of the Facility. All work will be done following the Casper Municipal Code and other relevant codes adopted therein.
- **Coordination of Events and Shared Parking.** The City, the manager of the Ford Wyoming Center, and WYO Complex, would closely coordinate and cooperate with each other to ensure that the two facilities are coordinating events. The City, and manager of the Ford Wyoming Center, and WYO Complex agree that they will meet monthly and annually as agreed, to coordinate events and parking to optimize the use of both facilities and negotiate in good faith to determine and implement alternate parking solutions as needed (e.g., shuttle bus services). WYO Complex's proposed site plan includes a parking lot of approximately 700 added spaces in close proximity to the facilities.

Financial Considerations

Rent and term stated above.

Potential increase in tax revenue.

Oversight/Project Responsibility

City Manager's Office

City Attorney's Office

Public Services

Attachments

Resolution

Ground Lease Agreement

Ground Lease Agreement
between
The City of Casper, Wyoming, Landlord
and
WYO Complex, Tenant
dated as of
_____, _____, 2022

TABLE OF CONTENTS

Article I	Definitions	3
Article II	Lease of Premises; Condition of Premises; Commencement Date Agreement; Failure to Deliver Possession	9
Article III	Base Rent; Rent Payable to Landlord; Net Lease	10
Article IV	Payment of Impositions; Reduction of Assessed Valuation; Utilities	11
Article V	Security	13
Article VI	Permitted Use	13
Article VII	Construction of Facility	14
Article VIII	Operation of the Premises	17
Article IX	Maintenance, Repairs and Alterations	17
Article X	Insurance	18
Article XI	Indemnification	21
Article XII	Assignment; Sublease; Non-Disturbance	21
Article XIII	Fee Mortgages; Leasehold Mortgages	23
Article XIV	Default; Remedies	25
Article XV	Expiration or Termination	28
Article XVI	Damage and Destruction	28
Article XVII	Condemnation	30
Article XVIII	Reserved	33
Article XIX	Notices	33
Article XX	Submission of Matters to Landlord for Approval	33
Article XXI	Holding Over	33
Article XXII	Compliance with Laws; Environmental Laws	34
Article XXIII	Brokers	35
Article XXIV	No impairment of Landlord's Title	35
Article XXV	Quiet Enjoyment	35
Article XXVI	Limitation of Landlord's Liability	35
Article XXVII	Reserved	35
Article XXVIII	Recording	36
Article XXIX	Extension Options	36
Article XXX	Miscellaneous	36

Ground Lease Agreement

This GROUND LEASE AGREEMENT (the "**Lease**") is made and entered into as of the _____ day of _____, 2022, by and between the City of Casper, Wyoming, a Wyoming municipal corporation with offices at 200 North David Street, Casper, Wyoming 82601 ("**Landlord**") and WYO Complex, a Wyoming non-profit corporation ("**Tenant**") (Landlord and Tenant are herein each a "**Party**" and are collectively referred to as the "**Parties**").

RECITALS:

WHEREAS, the governing body of the Landlord has the authority to lease any estate owned and make any orders respecting it deemed to be its best interest under Wyoming Statute § 15-1-103(a)(iv); and,

WHEREAS, the City Council is the governing body of the Landlord; and,

WHEREAS, the Landlord has real property the Tenant wants to lease for use as an indoor recreational sports facility, parking lot and other appurtenances; and,

WHEREAS, the City Council finds that leasing the property as described herein will further the community and economic development of the City by: (1) increasing the availability of court and turf space for youth sports and recognizing the importance of youth sports boosting physical and mental health of the communities' youth (2) making a space available for the creation of a multi-million dollar sports and events complex facility at no cost to the taxpayers; (3) allowing regional tournaments and significant events to be hosted in Casper; (4) creating a space and entity for coordination of events with the Ford Wyoming Center to draw more events to the City, and (5) increasing the number of visitors to the City, bringing the revenue associated therewith.

WHEREAS, the City Council deems it in the best interest of the Landlord to lease the property to the Tenant as described in this Lease.

NOW, THEREFORE, in consideration of the rents reserved and covenants made herein, the sufficiency of which is acknowledged, Landlord and Tenant, for themselves, their permitted successors and assigns, hereby agree as follows:

I. DEFINITIONS

Section 1.01 Definitions. The following terms, as used in this Lease, shall have the meanings set forth below:

"**Additional Rent**" shall mean all amounts payable by Tenant under this Lease, other than Base Rent, and whether or not expressly designated as Additional Rent in this Lease.

"**Affiliate**" shall mean a Person which shall control, be under the control of, or be under common control with the Person in question.

"**Alteration**" or "**Alterations**" shall have the meaning set forth in Section 9.02 hereof.

"**Approval Date**" shall mean the date that all of the Approvals are issued for the construction of the Facility, and all appeal periods for the Approvals have expired.

"**Approvals**" shall mean all approvals of Governmental Authorities required for the construction of the Facility and for any Alteration, as applicable.

"**Assignment**" shall mean the sale, exchange, assignment, or other disposition of all of Tenant's interest in this Lease and the leasehold estate created thereby, whether by operation of Law or otherwise.

"**Base Rent**" shall have the meaning set forth in Section 3.01 hereof.

"**Broker**" shall have the meaning set forth in Section 23.01 hereof.

"**Business Day**" shall mean any day that is not a Saturday, Sunday, or a day observed as a holiday by either the Landlord, State or the federal government.

"**Certificate of Occupancy**" shall mean a certificate issued by the appropriate Governmental Authority permitting the occupancy of the Facility. For purposes hereof, a temporary Certificate of Occupancy shall be deemed to be a Certificate of Occupancy but shall be replaced with a permanent Certificate of Occupancy before the expiration of such temporary Certificate of Occupancy.

"**CGL**" shall have the meaning set forth in Section 10.04 hereof.

"**Commencement Date**" shall mean October 1, 2022.

"**Commencement of Construction**" shall mean the date on which on-site construction of the Facility shall commence, including any excavation or pile driving, but not including test borings, test pilings, surveys, and similar pre-construction activities.

"**Construction Commencement Date**" shall mean the date that is twelve (12) months following the Approval Date or as agreed upon between the parties in writing.

"**Completion Date**" shall mean the date that is forty-eight (48) months following the Approval Date or as agreed upon between the parties in writing.

"**Condemnation**" shall mean the taking or appropriation of all or any part of the Premises, or any interest therein or right accruing thereto including any right of access, by or on behalf of any Governmental Authority or by any entity granted the authority to take property in the exercise of the power or right of eminent domain granted by statute, or any agreement that conveys to the condemning authority all or any part of the Premises as the result of, in lieu of, or in anticipation of, the exercise of a right of condemnation or eminent domain. Such term shall also be deemed to include, to the extent not otherwise defined herein, a temporary taking of the Premises or any part thereof or the Improvements thereon for a period of eighteen (18) months or more, and the taking of the leasehold interest created herein.

"**Construction Agreement**" shall mean that certain agreement to be entered into with Contractor for the construction of the Facility.

"**Contract Documents**" shall have the meaning set forth in Section 7.04 hereof.

"**Contractor**" shall mean the contractor who will enter into a Construction Agreement with Tenant for the construction and development of the Facility.

"**Date of Taking**" shall mean the earlier of the date, pursuant to the provisions of applicable State or federal Law, on which: (a) actual possession of all or part of the Premises, as the case may

be, is acquired by the appropriate Governmental Authority; or (b) title to all or part of the Premises, as the case may be, is vested in the appropriate Governmental Authority.

"Deficiency" shall have the meaning set forth in Section 14 02(d) hereof.

"Depository" shall mean the Leasehold Mortgagee holding the Leasehold Mortgage having the highest priority. If there is no Leasehold Mortgagee, or if Leasehold Mortgagee declines to act as Depository, then the Depository shall mean a savings bank, savings and loan association, commercial bank, or trust company designated by Tenant and approved by Landlord, which approval shall not be unreasonably withheld, conditioned, or delayed, to serve as Depository pursuant to an agreement reasonably acceptable to Landlord and Tenant. If Tenant shall fail to designate a Depository within ten (10) Business Days after the request of Landlord, Landlord shall have the right to designate such Depository.

"Due Date" shall mean with respect to (a) Base Rent and Additional Rent, the date on which such Base Rent or Additional Rent payment is due as provided in this Lease; and (b) any Imposition, the last date on which such Imposition can be paid without any fine, penalty, interest, or cost being added thereto or imposed by Law for the nonpayment thereof.

"Embargoed Person" shall have the meaning set forth in Section 30 10.

"Environmental Laws" shall mean all Laws: (a) relating to the environment, human health, or natural resources; (b) regulating, controlling, or imposing liability or standards of conduct concerning any Hazardous Materials; (c) relating to Remedial Action, and (d) requiring notification or disclosure of releases of Hazardous Materials or of the existence of any environmental conditions on or at the Premises, as any of the foregoing may be amended, supplemented, or supplanted from time to time.

"Executive Order" shall have the meaning set forth in Section 30 10 hereof.

"Expiration Date" shall mean the last day of the month in which occurs the ninety-ninth (99th) anniversary of the Commencement Date, as same may be extended pursuant to ARTICLE XXIX hereof, or such earlier date on which the Term shall sooner end pursuant to any of the terms, covenants, or conditions of this Lease or pursuant to Law.

"Extension Notice" shall have the meaning set forth in Section 29.02 hereof.

"Extension Rent" shall have the meaning set forth in Section 29 02 hereof.

"Extension Term" shall have the meaning set forth in Section 29 01 hereof.

"Extension Option" shall have the meaning set forth in Section 29.01 hereof.

"Event of Default" shall have the meaning set forth in Section 14 01 hereof.

"Facility" shall mean the building to be constructed on the Land by Tenant pursuant to this Lease that is an indoor sports facility and parking lot, together with all fixtures now or in the future installed or erected upon the Land or Improvements.

"Fee Mortgage" shall mean any financing obtained by Landlord, as evidenced by any mortgage, deed of trust, assignment of leases and rents, or other instruments, and secured by the fee ownership interest of Landlord in the Property, including any extensions, modifications, amendments, replacements, supplements, renewals, refinancings, and consolidations thereof.

"Fee Mortgagee" shall mean the holder of a Fee Mortgage.

"Force Majeure Event" means any of the following events: (a) acts of God; (b) floods, fires, earthquakes, hurricanes, tornadoes, explosions, or other natural disasters, (c) war, invasions, hostilities (whether war is declared or not), terrorist threats or acts, riots or other civil unrest; (d) governmental authority, proclamations, orders, laws, actions, or requests; (e) embargoes or blockades, (f) epidemics, pandemics, or other national or regional emergencies; (g) strikes, labor stoppages or slowdowns, or other industrial disturbances; and (h) other similar events.

"Force Majeure Noticing Party" is defined in Section 30 11(b).

"Governmental Authority or Governmental Authorities" shall mean the United States of America, the State, the County of Natrona the City of Casper, Wyoming, any political subdivision of any of the foregoing, and any other governmental or regulatory authority, agency, board, department, or any other public or quasi-public authority, having jurisdiction over the Premises or the matter at issue.

"Hazardous Materials" shall mean any and all substances, materials, chemicals, or wastes that now or hereafter are classified or considered to be hazardous or toxic under any Environmental Law, or that are or become regulated by any Governmental Authority because of toxicity, infectiousness, radioactivity, explosiveness, ignitability, corrosiveness, or reactivity under any Environmental Law applicable to the Premises, and shall also include: (a) gasoline, diesel fuel, and any other petroleum hydrocarbons; (b) asbestos and asbestos containing materials, in any form, whether friable or non-friable; (c) polychlorinated biphenyls; (d) radon gas; and (e) flammable liquids and explosives.

"Impositions" shall mean any and all. (a) property taxes of every kind and nature; (b) property assessments (whether general, special, business improvement district, shared parking or otherwise); (c) personal property taxes; (d) water, water meter, sewer rents, rates, and charges; and (e) any and all other governmental levies, fees, rents, assessments, or taxes and charges, general and special, ordinary and extraordinary, foreseen and unforeseen, of any kind and nature whatsoever, and any interest or costs with respect thereto, which at any time during the Term are, or, if the Premises or any part thereof or the owner thereof were not exempt therefrom, would have been assessed, levied, confirmed, imposed upon, or would have become due and payable out of or in respect of, or would have been charged with respect to, the Premises (excluding any capital gains taxes imposed in connection with the execution of this Lease).

"Improvements" shall mean all buildings and other improvements now located, or hereafter erected, on the Land (including the Facility), together with all fixtures now or in the future installed or erected in or upon the Land or such improvements owned or leased by Landlord or Tenant.

"Indemnitees" shall have the meaning set forth in Section 11.01 hereof.

"Initial Construction" shall mean the design, development, and construction of the Facility, including all related demolition and excavation.

"Interest Rate" shall mean the Prime Rate plus ten percent (10%) *per annum* but, in no event, in excess of the maximum permissible interest rate then in effect in the State.

"Land" shall mean all that certain plot, piece, or parcel of land, approximately 14.5 acres, located in the City of Casper, County of Natrona, State of Wyoming and which land is legally described in Exhibits A and B, attached hereto and incorporated herein.

"Land Value" shall mean, as of any date, the fair market value of the Land, as determined by Landlord. For purposes herein, the term "fair market value" is deemed to be the price that a willing buyer would offer, and a willing seller would accept, for all of the seller's right, title, and interest in the Land, considered as encumbered by this Lease with all extension options exercised, unencumbered by any Fee Mortgage, vacant, and unimproved.

"Law" or "Laws" shall mean any present or future applicable law, statute, ordinance, regulation (including zoning regulations), code, building code, judgment, injunction, arbitration award, order, rule, directive, common law, codes and ordinances of any Governmental Authorities, easement, covenant, restriction, or other agreement of record affecting the Premises as of the date of this Lease or subsequent thereto.

"Leasehold Mortgage" shall mean any loan financing obtained by Tenant, as evidenced by any mortgage, deed of trust, or other instrument and secured by Tenant's interest in this Lease and the leasehold estate created hereby, including any extensions, modifications, amendments, replacements, supplements, renewals, and refinancing thereof.

"Leasehold Mortgagee" shall mean the holder of a Leasehold Mortgage.

"Liabilities" shall mean all losses, claims, suits, demands, costs, liabilities, and expenses, including reasonable attorneys' fees, penalties, interest, fines, judgment amounts, fees, and damages, of whatever kind or nature.

"Major Sublease" shall mean a Sublease of not less than ten percent (10%) of the total rentable square feet of the Facility, or any other ground lease on the property (e.g., cell tower lease).

"Major Subtenant" shall mean a Subtenant under a Major Sublease.

"Mortgagee Lease" shall have the meaning set forth in Section 13 07 hereof.

"Outside Delivery Date" shall mean December 30, 2022.

"Party" or "Parties" shall have the meaning set forth in the Preamble.

"Patriot Act" shall have the meaning set forth in Section 30 10 hereof.

"Permitted Use" shall mean the use of the Premises as a sports, education, and events facility with associated parking.

"Person" shall mean any individual, corporation, partnership, firm, or other legal entity

"Plans" shall have the meaning set forth in Section 7.05 hereof.

"Premises" shall mean the Land, any Improvements thereon (including the Facility, as applicable), and any and all rights, privileges, easements, and appurtenances to the Land and the Improvements and any development rights.

"Prime Rate" shall mean the prime or base rate published in the Wall Street journal, and if not available, a comparable rate selected by Landlord. Any interest payable under this Lease with reference to the Prime Rate shall be adjusted on a daily basis, based upon the Prime Rate in effect at the time in question, and shall be calculated on the basis of a 360-day year with twelve (12) months of thirty (30) days each.

"Prohibited Person" shall have the meaning set forth in Section 30 10 hereof.

"Property Reports" shall have the meaning set forth in Section 7.14 hereof.

"Qualified Appraiser" shall mean an appraiser that: (a) is duly licensed in the jurisdiction in which the Premises are located; (b) has at least five years (5) years' experience, on a full-time basis, leasing space in the same general geographic area as that in which the Premises are located; and (c) is independent and has no then-pending or past brokerage relationship with any or all of Landlord, Tenant, and any Affiliates of either or both of Landlord and Tenant.

"Release" shall mean the release or threatened release of any Hazardous Materials into, upon, under, or above any land, water, or air, or otherwise into the environment, including by means of burial, disposal, discharge, emission, spillage, leakage, seepage, leaching, or dumping.

"Remedial Action" shall mean the investigation, response, clean up, remediation, prevention, mitigation, or removal of any Hazardous Materials necessary to comply with any Environmental Laws.

"Rent" shall mean Base Rent and Additional Rent.

"Rent Commencement Date" shall mean the date that is thirty days after the Landlord's governing body passes a resolution approving this Lease.

"Restoration" shall have the meaning set forth in Section 16.01 hereof.

"Restoration Funds" shall have the meaning set forth in Section 16.02 hereof.

"Restore" shall have the meaning set forth in Section 16.01 hereof.

"Security" shall mean the amount of Fifty Thousand Dollars (\$50,000.00).

"Schedule of Performance" shall have the meaning set forth in Section 7.04 hereof.

"State" shall mean the State of Wyoming.

"Sublease" shall mean any lease, sublease, occupancy, license, or concession agreement for the use or occupancy of space in the Improvements (other than this Lease).

"Substantial Completion, Substantially Complete, and Substantially Completed" shall mean, with respect to the Initial Construction and all Alterations, the satisfaction of the following conditions: (a) Tenant shall have obtained and delivered to Landlord all Approvals required by Law to be issued in connection with the Initial Construction or Alteration, as applicable, including any Certificate of Occupancy or amendment of the Certificate of Occupancy; and (b) Tenant delivers to Landlord a final release and waiver of mechanics' liens covering all of the Initial Construction or Alteration, as applicable, in form and substance reasonably satisfactory to Landlord, executed by each of the general contractor, construction manager, design builder, contractors, and subcontractors.

"Substantially all of the Premises" shall mean. (a) that portion of the Premises in excess of ten percent (10%) of the total rentable area of the Improvements; or (b) if the Improvements include a parking lot or parking facility, more than twenty percent (20%) of the total number of parking spaces available at the Premises.

"Subtenant" shall mean any tenant, subtenant, licensee, or other occupant of space in the Improvements (other than Tenant).

"Term" shall mean the term of this Lease commencing on the Commencement Date and ending on the Expiration Date.

"Threshold Amount" shall mean twenty-five percent (25%) of the fair market value of the Premises. Fair market value shall be determined by an appraisal or as otherwise agreed to in writing by the Parties.

"Transfer" shall mean any transaction or series of transactions (including any assignment, transfer, issuance, or redemption of any ownership interest, or any merger, consolidation, or dissolution) that results in a change of control of Tenant or any Person or entity which directly or indirectly controls Tenant. Notwithstanding the foregoing, a Transfer shall not be deemed to include the change in Board members in the normal course of nonprofit operations.

"Transferee" shall have the meaning set forth in Section 12.01 hereof.

II. LEASE OF PREMISES; CONDITION OF PREMISES; COMMENCEMENT DATE AGREEMENT; FAILURE TO DELIVER POSSESSION

Section 2.01 Lease of Premises. Subject to the terms and conditions of this Lease, Landlord leases to Tenant, and Tenant leases from Landlord, the Premises for a Term that shall commence on the Commencement Date and end on the Expiration Date (as such Term may be extended from time to time pursuant to Article XXIX hereof), subject to earlier termination pursuant to any of the terms, covenants, or conditions of this Lease or pursuant to Law.

Section 2.02 Condition of Premises. Tenant has inspected the Premises and accepts possession of the Premises in its "AS IS" condition on the Commencement Date. Except as otherwise expressly provided in this Lease, Tenant has full responsibility for the repair, alteration, maintenance, and replacement of the Premises. Tenant expressly acknowledges and agrees that Landlord has not made and is not making, and Tenant is not relying upon, any warranties or representations regarding the Premises, except to the extent same are expressly set forth in the Lease. Notwithstanding the foregoing, Tenant can inspect the Premises for hazardous waste and if discovered prior to Commencement of Construction, terminate its obligations hereunder pursuant to Article XV

Section 2.03 Failure to Deliver Possession. If Landlord shall fail to deliver vacant possession of the Premises on the Commencement Date, Landlord shall have no liability to Tenant and this Lease shall remain in full force and effect according to its terms, but the Term shall not commence until the date on which Landlord delivers vacant possession of the Premises to Tenant. Notwithstanding the foregoing, if Landlord fails to deliver vacant possession of the Premises on or before the Outside Delivery Date, Tenant may at its option, upon thirty (30) days' prior written notice to Landlord, elect to terminate this Lease by giving Landlord a notice of termination. Upon the date that is thirty (30) days following receipt of such notice by Landlord, this Lease shall terminate and be of no further force and effect, the parties shall have no further liability to the other (except for those Liabilities that expressly survive the termination of the Lease) and Landlord shall return to Tenant the Security. Notwithstanding the foregoing, if Landlord delivers vacant possession of the Premises within such thirty (30)-day period following its receipt of Tenant's notice of termination, Tenant's notice shall be void and of no further force and effect and this Lease shall not terminate.

III. BASE RENT; RENT PAYABLE TO LANDLORD; NET LEASE

Section 3.01 Base Rent.

- (a) Tenant covenants and agrees to pay base rent to Landlord throughout the Term of this Lease as follows ("**Base Rent**"):
 - (i) For the period commencing on the Commencement Date and ending on the Expiration Date, an amount equal to One Dollar (\$1 00) *per annum*, payable (subject to Section 3 02(c)); and
- (a) If Tenant exercises an Extension Option in accordance with the terms of Article XXIX of this Lease and the Lease Term is extended, the Base Rent payable with respect to such Extension Term shall remain the same.

Section 3.02 Rent Payable to Landlord.

- (a) Tenant shall pay Base Rent to Landlord in equal monthly installments, in advance, commencing on the first day of each month during the Term, without notice or demand.
- (b) Tenant shall pay to Landlord all Additional Rent that is payable to Landlord pursuant to the terms and conditions of this Lease within thirty (30) days after written demand therefore from Landlord, unless a different time period is specified in this Lease.
- (c) All Base Rent and Additional Rent (such Additional Rent that is due and owing to Landlord pursuant to the terms and conditions of this Lease) shall be paid. (i) by good check drawn on an account at a bank in currency that at the time of payment is legal tender for public and private debts in the United States of America, made payable to Landlord at Landlord's address set forth in Section 19.01 herein or to such other parties and at such other addresses as Landlord shall direct by notice to Tenant from time to time; (ii) if Landlord shall so direct (at any time upon not less than thirty (30) days' prior notice), by wire transfer of immediately available funds to an account at a bank designated in writing by Landlord; or (iii) by any other method reasonably designated in writing by Landlord.
- (d) If any installment of Base Rent or Additional Rent (such Additional Rent that is due and owing to Landlord) is not paid within thirty (30) days of the applicable Due Date, Tenant shall pay to Landlord, as Additional Rent:
 - (i) A late charge of Fifty Dollars (\$50 00) in order to defray the expenses incident to handling such delinquent payments. Such payment shall be in addition to, and not in lieu of, any other remedy Landlord may have; and
 - (ii) Interest on the overdue amount to Landlord at the Interest Rate. Such overdue Rent shall bear interest from the Due Date, without regard to any grace period,

until the date such Rent is paid. Such payment shall be in addition to, and not in lieu of, any other remedy Landlord may have.

Section 3.03 Net Lease. This Lease is an absolute net lease. Tenant shall pay as Additional Rent all expenses of every kind and nature whatsoever relating to or arising from the Premises, including all expenses arising from the leasing, operation, management, construction, maintenance, repair, use, and occupancy of the Premises, except as otherwise expressly provided in this Lease. Notwithstanding the foregoing, Landlord agrees to pay the following expenses: (a) any expenses expressly agreed to be paid by Landlord in this Lease; (b) expenses incurred by Landlord to monitor and administer this Lease; (c) expenses incurred by Landlord prior to the Commencement Date.

IV. PAYMENT OF IMPOSITIONS; REDUCTION OF ASSESSED VALUATION; UTILITIES

Section 4.01 Payment of Impositions.

- (a) During the Term of this Lease, Tenant shall pay or shall cause to be paid all Impositions directly to the Governmental Authority charged with the collection thereof. Each Imposition, or installment thereof, during the Term shall be paid prior to or by the Due Date thereof. However, if, by Law, any Imposition may at the option of the taxpayer be paid in installments (whether or not interest shall accrue on the unpaid balance of such Imposition), Tenant may exercise the option to pay the same in such installments and shall be responsible for the payment of such installments only, together with applicable interest, if any; provided that all such installment payments together with applicable interest, if any, relating to periods prior to the Expiration Date shall be made prior to the Expiration Date. Tenant shall promptly notify Landlord if Tenant shall have elected to pay any such Imposition in installments.
- (b) Tenant shall, within thirty (30) days following each Due Date, furnish to Landlord official receipts of the appropriate Governmental Authority, or other evidence reasonably satisfactory to Landlord, evidencing the payment of such Impositions.
- (c) Tenant shall have the right to contest the amount or validity, in whole or in part, of any Imposition by appropriate proceedings diligently conducted in good faith, in which event, notwithstanding the provisions of this Article IV, payment of such Imposition shall be postponed if, and only as long as:
 - (i) Neither the Premises nor any part thereof, or interest therein or any income therefrom (except to the extent covered by security deposited in accordance with this Section 4.01(e)(i)) would by reason of such postponement or deferment, be, in the reasonable judgment of Landlord, in imminent danger of being forfeited or lost or subject to any lien, encumbrance, or charge, and neither Landlord nor Tenant would by reason thereof be subject to any civil or criminal liability;

- (ii) Tenant shall have deposited with Depository cash or a letter of credit in a form and from an issuer reasonably satisfactory to Landlord in the amount so contested and unpaid, together with all interest and penalties in connection therewith and all charges that may or might be assessed against or become a charge on the Premises or any part thereof in such proceedings, or such other security as shall be reasonably satisfactory to Landlord; and
 - (iii) No Event of Default has occurred and is continuing (in which event only Landlord may commence such proceedings but shall have no obligation to do so).
- (d) Upon the termination of such proceedings, it shall be the obligation of Tenant to pay the amount of such Imposition or part thereof as finally determined in such proceedings, the payment of which may have been deferred during the prosecution of such proceedings, together with any costs, fees (including reasonable attorneys' fees and disbursements), interest, penalties, or other liabilities in connection therewith. Upon such payment, Depository shall return, with interest, if any, any amount deposited with it as aforesaid; provided, however, that Depository at Tenant's request or upon Tenant's failure to do so in a timely manner, at Landlord's request, shall disburse said moneys on deposit with it directly to the Governmental Authority to whom such Imposition is payable and any remaining monies, with interest, if any, shall be returned promptly to Tenant.
- (e) Landlord shall not be required to join in any proceedings referred to in this Article IV unless the provisions of any Law at the time in effect shall require that such proceedings be brought by or in the name of Landlord, in which event, Landlord shall join and reasonably cooperate in such proceedings or permit the same to be brought in its name but shall not be liable for the payment of any costs or expenses in connection with any such proceedings and Tenant shall reimburse Landlord for any and all costs or expenses which Landlord may reasonably sustain or incur in connection with any such proceedings, including reasonable attorneys' fees and disbursements.
- (f) In the event that a Leasehold Mortgagee shall require Tenant to deposit funds with such Leasehold Mortgagee to ensure payment of Impositions, any amount so deposited by Tenant with such Leasehold Mortgagee shall be credited against the amount, if any, which Tenant would otherwise be required to deposit under this Section 4.01
- (g) If there shall be any refunds or rebates on account of any Impositions paid by Landlord or Tenant, such refund or rebate shall belong to the party that paid the Imposition.

Section 4.02 Reduction of Assessed Valuation. Subject to the provisions of any Leasehold Mortgage, Tenant may, at Tenant's sole cost and expense, endeavor from time to time to reduce the assessed valuation of the Premises for the purpose of reducing the Impositions payable by Tenant. Landlord agrees to offer no objection to such contest or proceeding and, at the request of Tenant, to reasonably cooperate with Tenant in pursuing such contest or proceeding, but without expense to Landlord. Tenant agrees to indemnify and hold Landlord harmless from all Liabilities arising by reason of or in connection with any such contest or proceeding. If all of any

part of an Imposition is refunded to either Landlord or Tenant (whether through cash payment or credit against Impositions), the party who paid the Imposition to which the refund relates shall be entitled to such refund to the extent such refund relates to any Imposition paid by such party.

V. SECURITY

Section 5.01 Security. Tenant will provide the Landlord with a \$50,000 security deposit before the issuance of a building permit, as security for Tenant's compliance with this Lease. The amount of the security deposit shall be \$50,000 throughout construction until final acceptance by the Landlord. Upon final acceptance by the Landlord, \$25,000 of the security deposit shall be refunded by the Landlord to the Tenant. Upon the occurrence and continuance of an Event of Default, Landlord may use all or any portion of the security deposit to cure the default or for the payment of any other amount due and payable from Tenant to Landlord in accordance with this Lease. In such event, Tenant shall, within thirty (30) days following Landlord's notice, deposit with Landlord additional funds in an amount sufficient to restore the full amount of the security deposit (without giving consideration to any interest accrued on the Security). Landlord shall not, unless required by any Law, pay interest to Tenant on the security deposit, and if Landlord is required to maintain the security deposit in an interest-bearing account or pay any interest to Tenant, Landlord shall retain the maximum amount of interest permitted under any Law (which Landlord may withdraw and retain annually or at any other times). Landlord shall not be required to exhaust its remedies against Tenant or the security deposit before having recourse to Tenant, the security deposit, or any other security held by Landlord, or before exercising any right or remedy. If there is then no uncured default, the security and any accrued and unpaid interest thereon, or any balance, shall be paid or delivered to Tenant promptly after the Expiration Date and Tenant's vacating of the Premises in accordance with this Lease. If Landlord's interest in the Premises is sold or leased, Landlord shall transfer the security deposit and any accrued and unpaid interest thereon, or any balance, to the new landlord and, upon such transfer, the assignor shall thereupon be automatically released by Tenant from all liability for the return of the security deposit or any interest (and Tenant agrees to look solely to the assignee for the return of the security deposit or any interest).

VI. PERMITTED USE

Section 6.01 Permitted Use.

- (a) Subject to all applicable Laws and this Lease, Tenant shall use the Premises only for the Permitted Use.
- (b) Tenant shall not use or occupy, nor permit or suffer the Premises or any part thereof to be used or occupied for any unlawful, illegal, or extra hazardous business, use, or purpose, or in such manner as to constitute a nuisance of any kind (public or private), or for any purpose or in any way in violation of the Certificate of Occupancy or of any Laws, or which may make void or voidable any insurance then in force on the Premises. Tenant shall take, immediately upon the discovery of any such unpermitted, unlawful, illegal, or extra hazardous use, all necessary actions, legal and equitable, to compel the discontinuance of such use.

VII. CONSTRUCTION OF FACILITY

Section 7.01 Preconditions to Commencing Construction. Tenant shall not commence construction of the Facility until Tenant has satisfied all of the following conditions:

- (a) If Tenant is obtaining financing for the construction of the Facility, Tenant has provided to Landlord. (i) a copy of a financing commitment letter from a Leasehold Mortgagee; and (ii) a written certification from Tenant that the financing commitment is in full force and effect.
- (b) Tenant has provided to Landlord written evidence that Tenant has sufficient funds available to it to complete the construction of the Facility
- (c) Landlord has approved the final Plans in accordance with Section 7.05 below
- (d) Tenant has delivered to Landlord the Security in accordance with Article V.
- (e) Tenant has delivered to Landlord a Construction Agreement meeting the requirements of this Article VII.
- (f) Tenant has provided to Landlord copies of all Approvals required by all applicable Governmental Authorities.
- (g) Subject to the requirements of any Leasehold Mortgagee, an assignment of all of Tenant's right, title, and interest in and to the Construction Agreement, the Plans, the Contract Documents, and all intellectual property rights related thereto, such assignment to be in form and substance reasonably acceptable to Landlord. Landlord agrees to not exercise its rights with respect to such assignment unless and until this Lease has been terminated and Leasehold Mortgagee has failed to exercise its rights to a Mortgagee Lease.
- (h) Tenant has obtained, and has caused its general contractors, and architects, to obtain, the insurance required under Article X and has delivered to Landlord certificates (or certified copies of policies, if requested by Landlord) evidencing such insurance.
- (i) Tenant, at its sole cost and expense, shall have completed and received site plan agreements, and received all required permits to construct its Facility, all in accordance with the requirements of the Casper Municipal Code.

Section 7.02 Construction of Facility. Tenant shall enter into a Construction Agreement for the design, development, and construction of the Facility. Tenant agrees to promptly provide to Landlord copies of the final form of the Construction Agreement for Landlord's records.

Section 7.03 Intentionally Left Blank.

Section 7.04 Commencement of Construction. Tenant shall commence and pursue the Initial Construction to Substantial Completion in accordance with the **Contract Documents** and in accordance with the construction schedule set forth in the Construction Agreement (subject to

Section 30 11) (the "**Schedule of Performance**"). Tenant shall provide a Schedule of Performance to Landlord in a format that shows the critical path and milestones for the construction of the project. If supply chain issues beyond Tenant's control impact the critical path and milestones for the project, the Schedule of Performance shall be adjusted in an equitable manner, along with the completion dates for the project.

Section 7.05 Construction Approvals by Landlord. Prior to commencing any excavation, construction, paving, or any other work associated with the Initial Construction, Tenant shall provide to Landlord for its approval five (5) sets of the preliminary design documents and the construction documents (the "**Plans**") in hard-copy format and 1 electronic version compatible with the City's latest version of Auto-Cad, fully identifying and describing all materials, signage, design, and **architectural 3-D renderings of the Facility**, and including, without limitation, those items listed on Exhibit C, attached hereto and incorporated herein and made a part hereof. Landlord shall have a period of thirty (30) Business Days after receipt to approve or reject such submissions. Approval or rejection shall be given by the City Manager or the City Manager's designee. Failure to approve or reject any submissions within such thirty (30) business day period shall be deemed approval by Landlord. Upon the approval or deemed approval of any submissions, Tenant may request from Landlord a description of measures to be taken by Tenant that will result in approval on resubmission (or why resubmission of any similar proposal would be rejected). Landlord agrees not to unreasonably withhold, condition, or delay the approval required by this Section 7 05. Notwithstanding the foregoing, Tenant shall comply with the Casper Municipal Code site plan and zoning requirements.

Section 7.06 Substantial Changes. Tenant will notify Landlord of any substantial changes in the Plans during Construction.

Section 7.07 Construction According to Approved Plans. All building materials for the Facility must be new and of good quality in accordance with the Contract Documents and Plans. All construction will be performed in a good and workmanlike manner and only by contractors and subcontractors that are properly licensed (as required by the State or Landlord), and bonded, registered, and insured in Wyoming to perform their respective work. Landlord reserves the right to monitor the Initial Construction, from its inception to its completion. Access to the construction site will be limited to those involved with the work. Prior to commencing construction, Tenant will provide a six-foot high chain link security fence (which may not contain razor or barbed wire) with lockable gates at the perimeter of the construction site and staging area.

Section 7.08 Liens Subordinate to Landlord. Tenant shall not create or permit to be created or to remain, and shall promptly discharge, any lien, encumbrance, or charge levied on account of any mechanic's, laborer's, or materialman's lien which might or does constitute a lien, encumbrance, or charge upon the Premises, or any part thereof, or the income therefrom, having a priority or preference over or ranking on a parity with the estate, rights, or interest of Landlord in the Premises or any part thereof, or the income therefrom. Nothing in this Lease shall be deemed or construed in any way as constituting the consent or request of Landlord, express or implied, by inference or otherwise, to the filing of any lien against the Premises by any contractor, subcontractor, laborer, materialman, architect, engineer, or other Person for the performance of any labor or the furnishing of any materials or services for or in connection with the Premises or any part thereof.

Section 7.09 Completion of Construction by Landlord. Tenant's failure to comply with the requirements of the Schedule of Performance and to Substantially Complete the Facility by the Completion Date (subject to Sections 7.04 and 30.11) shall be deemed to be a material default under this Lease and Landlord shall have the right to pursue any and all of its remedies as set forth in Section 14.02 hereof and any and all of its rights and remedies at law and in equity. Tenant covenants and agrees that in the event: (a) Tenant abandons or fails to Substantially Complete the Facility by the Completion Date (subject to Sections 7.04 and 30.11); (b) such failure is not the result of Landlord's being in material default under this Lease; and (c) the Leasehold Mortgagee does not elect to complete construction of the Facility, Landlord may, at its option (but without any obligation so to do and without prejudice to any other rights Landlord may have under this Lease) complete the construction of the Facility undertaken by Tenant as an expense of the Premises and, as nearly as practicable, according to the Plans previously approved by the Landlord.

Section 7.10 Title to the Improvements. The title to all Improvements now or hereafter located on the Premises, including the improvements that are to be constructed in accordance with the Plans and Contract Documents, shall be vested in Tenant until either the termination or expiration of this Lease, at which time all title to and ownership of the Improvements shall automatically and immediately vest (without the necessity of any further action being taken by Tenant or Landlord or any instrument being executed and delivered by Tenant to Landlord) in Landlord.

Section 7.11 Architects, Engineers, Contractors. Tenant shall require any architects, engineers, and Contractor(s), engaged in connection with the construction of the Facility to perform their respective obligations under the terms of the Contract Documents, to be licensed in accordance with the Laws of the State, and to obtain and maintain for a period of ten (10) years after the Substantial Completion of the Facility errors and omissions insurance pursuant to Section 10.05 and payment and performance bonds pursuant to Section 7.13 of this Lease.

Section 7.12 Permits, Laws, and Ordinances. Tenant shall, at its sole cost and expense, comply and cause its contractors and subcontractors to comply in all material respects with all Laws of all Governmental Authorities which may now or hereafter, from time to time, be established and which are or shall be applicable to Tenant or Landlord as they relate to the Premises and shall take, as otherwise provided herein, all action necessary to cause the Premises to comply in all material respects with all provisions of the Contract Documents, the loan documents evidencing and securing the Leasehold Mortgage, and this Lease.

Section 7.13 Payment and Performance Bonds. Tenant shall provide or cause to be provided to Landlord payment and performance bonds from a qualified surety holding a B+ rating or higher, in accordance with the Contract Documents, to include requiring the contractor and all subcontractors (unless subcontractors are included in the Contractor's payment and performance bond) to provide payment and performance bonds. The bonds shall be dual obligee surety bonds payable to and in favor of Tenant as obligee and Landlord as additional obligee.

Section 7.14 Reports and Information. Tenant shall deliver or cause to be delivered to Landlord copies of all soil reports, surveys, hazardous waste or toxic materials reports, feasibility studies, and other similar written materials prepared for Tenant pursuant to the Contract

Documents with respect to the Premises (collectively, the "**Property Reports**") within thirty (30) days after receipt by Tenant.

Section 7.15 Substantial Completion of Facility. As soon as is practicable (however, in no event to exceed sixty (60) after the Substantial Completion of the Facility), Tenant will furnish to Landlord:

- (a) One complete set of final "as-built" plans and specifications of the completed improvements in autoCAD® format; and
- (b) A current, accurate, properly labeled, and certified (by the hereafter stated surveyor or engineer), "as-built" plat of survey prepared by a Wyoming registered land surveyor or professional engineer depicting to scale the location of the completed improvements, as the same have been constructed.

VIII. OPERATION OF THE PREMISES

Section 8.01 Tenant's Operation of the Premises. Upon completion of construction of the Facility, Tenant will operate the Premises in accordance with all Laws governing the Premises and this Lease.

Section 8.02 Mechanics' Liens. Tenant shall keep the Premises and this Lease free from any lien or other encumbrance filed or recorded in favor of any mechanic, materialman, architect, or engineer in accordance with Section 7.08 hereof.

Section 8.03 Utilities. Tenant shall obtain and pay for all utilities directly from and to the utilities and vendors serving the Premises, including, but not limited to, fuel, gas, electric, water and sewer service, trash collection, telephone, and internet service.

IX. MAINTENANCE, REPAIRS, AND ALTERATIONS

Section 9.01 Maintenance and Repair of the Premises. Tenant shall, at all times during the Term of this Lease, at Tenant's sole cost and expense, keep and maintain the Premises, including the Improvements, appurtenances, and every part thereof that may exist on, in, or be made a part of the Premises, in good order and condition, ordinary wear and tear excepted, and make all necessary repairs thereto, interior and exterior, structural and nonstructural, ordinary and extraordinary, and foreseen and unforeseen. If Tenant fails to keep and maintain the Premises in accordance with the Casper Municipal Code and the Improvements as required by this Lease, Landlord may (but shall not be required to) perform and satisfy same, and Tenant hereby agrees to reimburse Landlord, as Additional Rent, for the reasonable cost thereof promptly upon demand. Tenant shall not permit any material waste of the Premises. Tenant shall keep the entire Premises, including adjoining sidewalks, substantially free of any accumulation of dirt, rubbish, snow, and ice. Unless otherwise expressly provided in this Lease, Landlord is not required to maintain, repair, clean, alter, or improve the Premises, or to provide any services to the Premises, except as described in Section 9 01 (a) below.

Section 9.01 (a). Landlord Obligation to Maintain Access and Road. Landlord shall, at all times during the Term of this Lease, at Landlord's sole cost and expense, keep and maintain in good repair Tenant's access to the Premises, specifically including Events Drive and Parking Lot Access Roads.

Section 9.02 Alterations. Tenant may, at its sole cost and expense, alter, replace, or remodel any Improvements upon the Premises ("**Alterations**"), provided that: (a) the Alterations are made in compliance with all Laws; (b) the Alterations are completed in accordance with general accepted construction standards; (c) any remodeling shall not materially diminish the value of Improvements or the Premises; and (d) Tenant shall not allow mechanic's or materialmen's liens to affix to the Premises because of the Alterations. In the event any Alterations are estimated to exceed a cost of Two Hundred Fifty Thousand Dollars (\$250,000) at a three percent (3%) increase for inflation each year from the date of commencement, Tenant shall provide security to the Landlord for such amount as provided for in Article V hereof.

X. INSURANCE

Section 10.01 Insurance. It is the intent of the parties that all risk of loss for the Premises be shifted to insurance to the maximum extent practicable. Accordingly, unless Landlord otherwise agrees in its sole discretion, Tenant shall maintain, or cause to be maintained, insurance covering the risks enumerated below. The premiums for such insurance shall be paid by Tenant, except for the coverages set forth in Section 10.10 hereof, which will be the responsibility for the party providing such insurance coverage. Such insurance shall be written on an occurrence basis unless Landlord otherwise consents in writing, but for errors and omissions insurance issued on a claims-made basis. The policy shall provide that: (a) such insurance shall be primary coverage without reduction or right of offset or contribution on account of any insurance provided by Landlord to itself or its officers, officials, or employees; (b) such insurance shall not be altered or cancelled without thirty (30) days' written notice to Landlord, (c) such insurance shall name Landlord as an additional insured, (d) any Fee Mortgagee and Leasehold Mortgagee shall be named as: (i) a loss payee or mortgagee on Tenant's property damage insurance policy under a standard mortgagee clause; and (ii) an additional insured on Tenant's liability insurance policies. The insurance policies purchased by Tenant must be issued by a company authorized to conduct business in the State or by a company acceptable to Landlord and which has a rating of A:VII or better by A.M. Best.

Section 10.02 Workers' Compensation and Employer's Liability. At all times prior to the expiration or earlier termination of this Lease during any construction conducted by or on behalf of Tenant in or on the Premises, Tenant shall maintain, and cause its contractors to maintain, Workers' Compensation Insurance as required by the Laws of the State. Tenant shall require all subcontractors performing work under this Lease to obtain an insurance certificate showing proof of Workers' Compensation and Employer's Liability Insurance.

Section 10.03 Property and Business Interruption Insurance. Tenant shall, at its sole cost and expense throughout the entire Term of this Lease:

- (a) Keep the Improvements insured against loss or damage by fire, windstorm, flood, earthquake, and such other, further, and additional risks as now are or hereafter may be embraced by the ISO special form and Builder's Risk extended coverage form or

endorsements or equivalent forms recognized by the State, with a deductible of no more than Ten Thousand Dollars (\$10,000) per occurrence, in each case in amounts equal to the full replacement cost of the Improvements from time to time. The full replacement cost shall be redetermined from time to time (but not more frequently than every five (5) years) at the request of Landlord, by a Qualified Appraiser designated by Tenant and approved by Landlord; and

- (b) Maintain business interruption insurance covering loss of revenues or other income by Tenant by reason of total or partial suspension of, or interruption in, the operation of the Premises caused by damage or destruction of the Premises, subject to the reasonable discretion of Landlord.

Section 10.04 Public Liability. At all times during the Term of this Lease, Tenant shall maintain a primary commercial general liability insurance ("CGL") policy covering all claims for bodily injury (including death) and property damage, including loss of use thereof, in an amount not less than Two Hundred Fifty Thousand Dollars (\$250,000) per occurrence and Five Hundred Thousand Dollars (\$500,000) in the aggregate, with deductible provisions not to exceed Ten Thousand Dollars (\$10,000) per occurrence, to include personal and advertising injury, general aggregate, products, and completed operations aggregate insurance beginning at the completion of each project component, and contract liability to cover all insurable obligations in this Lease. The Parties recognize that the policy limits set forth in this Section are the maximum limits of liability for the Landlord under the Wyoming Governmental Claims Act ("WGCA"), W S § 1-39-101 *et seq.* If the Wyoming Legislature increases the amounts for which the City may be liable under the WGCA, the policy limits shall be increased to match. Coverage shall be specific for this project or, upon approval of Landlord, covered under umbrella or pooled policies. The policy or policies must be on an "occurrence" basis unless waived by Landlord. The CGL policy shall include contractual liability coverage, which shall be endorsed to state that indemnity obligations specified in this Lease are insured by the carrier

Section 10.05 Errors and Omissions. Tenant shall obtain and maintain or cause to be obtained and maintained Professional Errors and Omissions Insurance covering all architects, engineers, specialists, and consultants in an amount and with coverage subject to the reasonable approval of Landlord. Coverages shall be specific for this project and not aggregated with insurance for other undertakings of the insureds.

Section 10.06 Umbrella. Tenant shall obtain and maintain an additional umbrella policy or all-risk coverage in an amount of Two and a Half Million Dollars (\$2,500,000) for any one occurrence and Five Million Dollars (\$5,000,000) in the aggregate, which shall include all insured coverages required by this Article X. The policy limits shall be reviewed and may be adjusted every five (5) years from the Commencement Date.

Section 10.07 Delivery of Insurance Certificates. Upon the commencement of this Lease and at each policy renewal date, Tenant shall furnish to Landlord, any Fee Mortgagee, and any Leasehold Mortgagee, at the addresses set forth in Section 19 01 of this Lease, insurance certificates or renewal certificates or, if requested by Landlord, Fee Mortgagee, or Leasehold Mortgagee, certified copies of policies, evidencing all insurance required to be carried by Tenant in accordance with the Lease. Such certificates or policies shall name Landlord as an insured and

shall name any Fee Mortgagee and Leasehold Mortgagee as mortgagee and loss payee, in accordance with the requirements contained in this Article X. The insurance certificate or policies, as applicable, must document that the liability insurance coverage purchased by Tenant includes contractual liability coverage to insure the indemnity agreement as stated.

Section 10.08 Evidence of Payment of Premiums. Tenant shall within thirty (30) days of payment furnish to Landlord duplicate receipts or satisfactory evidence of the payment of all premiums on any and all insurance required to be carried by Tenant in accordance with this Lease. The insurance carrier shall give Landlord, any Fee Mortgagee, and any Leasehold Mortgagee thirty (30) days' prior notice (with respect to nonpayment of premiums) of cancellation, modification, or non-renewal.

Section 10.09 Payments for Tenant by Landlord. If Tenant fails to procure the insurance required to be procured by Tenant under this Lease, or fails to pay any premium of insurance, Impositions, or any other sum in this Lease required to be paid by Tenant (other than Rent), Landlord may, after expiration of the applicable cure period, at Landlord's option, procure on behalf of Tenant any such insurance, and pay on behalf of Tenant any such payment or payments as may be necessary. Any sums so paid or expended by Landlord on behalf of Tenant shall immediately be reimbursed and paid by Tenant to Landlord, as Additional Rent, within ten (10) days after demand by Landlord.

Section 10.10 Insurance Requirements for Subtenants and Contractors. Tenant also shall require the Persons described below to carry the following insurance:

- (a) Tenant shall require all of its Subtenants to:
 - (i) Maintain customary insurance required of tenants in similar properties (which insurance, as to any tenant serving liquor, shall include liquor law sales and dramshop coverage);
 - (ii) Include Landlord and Tenant as additional insureds on their commercial general liability policies (or equivalent policies);
 - (iii) Obtain a waiver of subrogation endorsement in all policies in favor of Landlord and Tenant; and
 - (iv) Include any Fee Mortgagee and Leasehold Mortgagee as: (A) a loss payee or mortgagee on each Subtenant's property damage insurance policy under a standard mortgagee clause; and (B) an additional insured on each Subtenant's liability insurance policies.
- (b) Tenant shall require all of its Subtenants' contractors, , design-builders, construction managers, consultants, and other entities providing services, materials, or labor to all or any portion of the Premises to:
 - (i) Include Landlord and Tenant as additional insureds in their commercial general liability policies; and

- (ii) Obtain a waiver of subrogation endorsement in all policies in favor of Landlord and Tenant.

The policy limits set forth above shall be adjusted every five (5) years from the Commencement Date. Each of the required coverages, excluding the professional liability insurance, fidelity insurance, and automobile liability insurance, shall contain a waiver of subrogation endorsement, in form and substance reasonably satisfactory to Landlord, in favor of Landlord and Tenant.

Section 10.11 Threshold Amount. The loss under all policies required by this Lease insuring against damage to the Premises by fire or other casualty shall be payable to Depository, except that amounts of less than the Threshold Amount shall be payable in trust directly to Tenant for application to the cost of Restoration in accordance with this Lease. Proceeds of business interruption insurance shall be paid to Depository and shall be applied to the Rent payable by Tenant under this Lease until completion of such Restoration by Tenant.

XI. INDEMNIFICATION

Section 11.01 Indemnification. Tenant hereby releases and agrees to indemnify and hold harmless Landlord and all of its trustees, officers, employees, directors, agents, and consultants (hereinafter collectively referred to as the "**Indemnitees**") of and from any and all claims, demands, liabilities, losses, costs, or expenses for any loss including but not limited to bodily injury (including death), personal injury, property damage, expenses, and attorneys' fees, caused by, growing out of, or otherwise occurring in connection with this Lease, due to any negligent or intentional act or omission on the part of Tenant, its agents, employees, or others working at the direction of Tenant, on its behalf, or due to the application or violation of any pertinent federal, State, or local Law except for the gross negligence or intentional misconduct of the Indemnitees. In case any action or proceeding is brought against Landlord by reason of any claim mentioned in this Article XI, Tenant, upon notice from Landlord, shall, at Tenant's expense, resist or defend such action or proceeding in Landlord's name, if necessary, by counsel for the insurance company, if such claim is covered by insurance, or otherwise by counsel approved by Landlord. Landlord agrees to give Tenant prompt notice of any such claim or proceeding. This indemnification is binding on the successors and assigns of Tenant, and this indemnification survives the expiration or earlier termination of this Lease, or the dissolution or, to the extent allowed by Law, the bankruptcy of Tenant. This indemnification does not extend beyond the scope of this Lease and the Contract Documents and the work undertaken thereunder, and does not extend to claims exclusively between the undersigned parties arising from the terms, or regarding the interpretation of, this Lease.

XII. ASSIGNMENT; SUBLEASE; NON-DISTURBANCE

Section 12.01 Assignment; Transfer; Major Sublease. Tenant shall have the right, subject to the applicable provisions of this Article XII, to enter into an Assignment, Transfer, or Major Sublease only with the approval of the governing body of the City of Casper and only with other non-profit corporation(s) or government entities providing public benefit (hereinafter called the "**Transferee**") provided that: (a) the Facility is Substantially Completed; (b) the Transferee is

not a debtor or debtor-in-possession in a voluntary or an involuntary bankruptcy proceeding; and (c) with respect to an Assignment or a Transfer, the Transferee assumes all of Tenant's obligations under this Lease thereafter arising and Landlord is provided with a fully-executed copy of the assignment and assumption agreement. The Parties further recognize that this Lease is provided to the Tenant at far less than the fair market value for leasing property of this nature and size, all in return for Tenant building a Facility that may help with economic development and provide public benefit to citizens of Casper. Therefore, Assignments, Transfers and Major Subleases are subject to the approval of the Casper governing body, including, but not limited to, determining: (a) whether any or all revenue generated thereunder must be shared with the Landlord; (b) whether the assignee or transferee is in a viable economic position to accept the assignment and maintain the Facility, and (c) whether an appropriate public benefit will be conferred. If Tenant's interest in this Lease is assigned in violation of the provisions of this Article XII, such Assignment shall be void and of no force and effect against Landlord. Neither any Assignment, Transfer, nor any subleasing, occupancy, or use of the Premises or any part thereof by any Person, nor any collection of Rent by Landlord from any Person other than Tenant, nor any application of any such Rent shall, in any circumstances, relieve Tenant of its obligations under this Lease on Tenant's part to be observed and performed.

Section 12.02 Subleases.

- (a) Tenant shall have the right, subject to the applicable provisions of this Article XII, to enter into Subleases with any Person who is not a debtor or debtor-in-possession in a voluntary or involuntary bankruptcy proceeding at the commencement of the Sublease term for the use permitted by this Lease.
- (b) Each Sublease shall provide that: (i) it is subordinate and subject to this Lease; and (ii) the fixed expiration date thereunder shall not extend beyond the Expiration Date.
- (c) Tenant shall not, without seeking Landlord's prior written consent, amend, or modify any Sublease in a manner which would cause such Sublease (as amended or modified) to violate the provisions of this Lease and Tenant shall deliver to Landlord, or shall cause to be delivered to Landlord, within ten (10) Business Days after the full execution and delivery thereof, a true and complete copy of any executed Sublease or any material amendment and modification thereto.

Section 12.03 Notice. Tenant shall notify Landlord of its intention to enter into any Assignment, Transfer, or Major Sublease at least ninety (90) days prior to the proposed effective date or commencement date of the foregoing.

Section 12.04 Copies to Landlord. Tenant shall deliver to Landlord, or shall cause to be delivered to Landlord, within forty-five (45) Days after the effective date of an Assignment or the commencement date of a Major Sublease: (a) in the case of an Assignment, a fully-executed copy of the instrument of assignment and assumption, or (b) in the case of a Major Sublease, a fully-executed copy of the Major Sublease.

Section 12.05 Assignment to Leasehold Mortgagee. Any other provisions of this Lease to the contrary notwithstanding, Tenant, and its permitted successors and assigns, shall have the

right to Transfer this Lease or any interest herein or any right or privilege appurtenant hereto which Tenant desires to Transfer to a Leasehold Mortgagee, to the extent permitted in Article XIII of this Lease. Landlord agrees to recognize any Leasehold Mortgagee as Tenant for the performance of all duties and obligations arising by reason of the interest of this Lease being so Transferred; provided, however, it is hereby agreed and acknowledged by Landlord and Tenant that Tenant and its permitted successors and assigns shall not be relieved of liability for the performance of such duties or obligations by any such Transfer

XIII. FEE MORTGAGES; LEASEHOLD MORTGAGES

Section 13.01 Fee Mortgages. Landlord may mortgage its fee ownership interest in the Premises subject to the provisions of Section 13 10 of this Lease.

Section 13.02 Mortgaging of the Leasehold. Tenant, and every permitted successor and assign of Tenant, shall have the right to encumber its interest in this Lease without Landlord's prior consent, provided that: (a) no Event of Default has occurred and remains uncured under this Lease; and (b) all rights acquired under the Leasehold Mortgage shall be subject to each of the provisions set forth in this Lease and to all rights and interests of the Landlord therein. If, from time to time, Tenant or Tenant's permitted successors or assigns shall encumber this Lease with a Leasehold Mortgage, and if the Leasehold Mortgagee delivers to Landlord an executed counterpart of such Leasehold Mortgage, together with each assignment thereof certified by the holder of the Leasehold Mortgage to be true, together with written notice specifying the name and address of Leasehold Mortgagee and the pertinent recording data with respect to the Leasehold Mortgage, Landlord agrees that, anything in this Lease to the contrary notwithstanding, from and after the date of receipt by Landlord of such notice and for the duration of such Leasehold Mortgage, the provisions of this Article XIII shall apply

Section 13.03 Consent to Amendment. There shall be no cancellation, surrender, modification, or amendment to this Lease by Landlord or Tenant without the prior written consent of Leasehold Mortgagee. Notwithstanding the foregoing (but, in any event, subject to Leasehold Mortgagee's curative rights set forth in Section 13 06 and Section 13 07 hereof), nothing herein shall be deemed to prohibit Landlord from terminating this Lease in accordance with its terms or exercising its option to purchase as provided for in this Lease. There shall be no material modification in the Leasehold Mortgage or related documentation without Landlord's prior written consent, which consent shall not be unreasonably withheld, conditioned, or delayed.

Section 13.04 Notices to Leasehold Mortgagees. Landlord, upon serving Tenant with any notice of default or termination, shall simultaneously serve a copy of such notice on Leasehold Mortgagee. The Leasehold Mortgagee shall then have the same period of time after service of the notice on it as was given to Tenant under this Lease to remedy or cause to be remedied Tenant's default under this Lease, and Landlord shall accept performances by, or at the instigation of, Leasehold Mortgagee as if it had been done by Tenant. Any notice required to be given to Leasehold Mortgagee shall be provided as set forth in Section 19 01 of this Lease.

Section 13.05 Curative Rights of Leasehold Mortgagees. In addition to the rights granted to Leasehold Mortgagee under Section 13.04 hereof, Leasehold Mortgagee shall have an

additional period of ninety (90) days to remedy or cause to be remedied any default of which it receives notice, provided such Leasehold Mortgagee shall reimburse Landlord, at the time of so remedying the default, for all reasonable costs and expenses to Landlord of maintaining, protecting, insuring, and operating the Premises during the additional ninety (90) -day period.

Section 13.06 Limitation on Termination Rights of Landlord. If Landlord shall elect to terminate this Lease by reason of any default of Tenant, Leasehold Mortgagee shall also have the right to postpone and extend the date of termination as fixed by the provisions of this Lease for a period of not more than ninety (90) days from the expiration of the ninety (90) day period specified in Section 13 05 hereof, provided that Leasehold Mortgagee shall have cured, or shall have caused to be cured, any then-existing monetary or nonmonetary defaults (with the exception of Tenant's nonmonetary defaults of such a nature that they cannot be cured by Leasehold Mortgagee) and meanwhile shall pay the Rent and other charges required to be paid under this Lease. Leasehold Mortgagee shall take steps necessary to acquire Tenant's interest and estate in this Lease by foreclosure of its Leasehold Mortgage, or otherwise, and shall prosecute such action to completion with due diligence. If at the end of the One Hundred Eighty (180) day period, Leasehold Mortgagee shall be actively engaged in steps to acquire Tenant's interest in the Lease, and all monetary defaults and nonmonetary defaults have been cured (with the exception of Tenant's nonmonetary defaults of such a nature that they cannot be cured by Leasehold Mortgagee), the time for Leasehold Mortgagee to comply with the provisions of this Section 13 06 shall be extended for such period as shall be reasonably necessary to complete these steps with reasonable diligence and continuity. In no event shall Leasehold Mortgagee have any obligation to cure any default of Tenant under this Lease.

Section 13.07 Mortgagee Lease. Landlord agrees that in the event of a termination of this Lease by reason of any default by Tenant, or if Tenant rejects the Lease in a bankruptcy proceeding, and subject to the rights herein granted to Leasehold Mortgagee, Landlord will enter into a lease (the "**Mortgagee Lease**") of the Premises with the Leasehold Mortgagee for the remainder of the Term effective as of the date of termination, at the same Rent and upon the same terms, provisions, covenants, and agreements as contained in this Lease, provided:

- (a) Leasehold Mortgagee shall make written request upon Landlord for the execution of such a Mortgagee Lease within ninety (90) days after the date of termination and shall, within ninety (90) days after its receipt from Landlord of a written statement of all sums then due to Landlord under this Lease, pay to Landlord all such sums (with the exception of sums due by reason of Tenant's indemnification obligations set forth in Article XI).
- (b) Leasehold Mortgagee shall pay to Landlord at the time of the execution and delivery of the Mortgagee Lease any sums that at the time of such execution and delivery would be due pursuant to this Lease but for the termination, and in addition, all reasonable attorneys' fees and expenses which Landlord shall have actually incurred.
- (c) Leasehold Mortgagee shall perform and observe all covenants contained in the Mortgagee Lease on Tenant's part to be performed during such period of time commencing with the date of the execution of the Mortgagee Lease and terminating

upon the expiration or earlier termination of the Mortgagee Lease or the abandonment or surrender of possession of the Premises under the Mortgagee Lease and shall further remedy any other conditions that Tenant was obligated to perform under the terms of this Lease.

- (d) Leasehold Mortgagee, as Tenant under the Mortgagee Lease, shall have the same right, title, and interest in and to the Premises.

Leasehold Mortgagee shall pay to Landlord at the time of the execution and delivery of the Mortgagee Lease any sums that at the time of such execution and delivery would be due pursuant to this Lease but for the termination, and in addition, all reasonable attorneys' fees and expenses which Landlord shall have actually incurred. Leasehold Mortgagee shall perform and observe all covenants contained in the Mortgagee Lease on Tenant's part to be performed during such period of time commencing with the date of the execution of the Mortgagee Lease and terminating upon the expiration or earlier termination of the Mortgagee Lease or the abandonment or surrender of possession of the Premises under the Mortgagee Lease and shall further remedy any other conditions that Tenant was obligated to perform under the terms of this Lease. **Section 13.08 Agreement Between Landlord and Leasehold Mortgagee.** Landlord, upon request, shall execute, acknowledge, and deliver to Leasehold Mortgagee an agreement, by and among Landlord, Tenant, and Leasehold Mortgagee (provided the same has been previously executed by Tenant and Leasehold Mortgagee) agreeing to all of the provisions of this Article XIII, in form and substance reasonably satisfactory to Leasehold Mortgagee and Landlord.

Section 13.09 No Merger. So long as any Leasehold Mortgage remains outstanding, the fee title and the leasehold estate created by this Lease shall not merge but shall always be kept separate and distinct, notwithstanding the union of such estates in either Landlord, Tenant, or a third party, by purchase or otherwise.

Section 13.10 Subordination of Fee Mortgage. If one or more Leasehold Mortgages is in effect, the following shall apply: (a) all Fee Mortgages shall be expressly subject and subordinate to this Lease, any Mortgagee Lease, and all amendments, modifications, and extensions thereof and shall include Fee Mortgagee's agreement to execute and deliver to Leasehold Mortgagee an agreement in accordance with Section 13.08 hereof; (b) Landlord shall not enter into any Fee Mortgage that violates this Section 13.10; (c) Tenant shall not subordinate this Lease without the prior written consents of all Leasehold Mortgagees; and (d) concurrently with the execution and delivery of this Lease, Landlord shall cause all Fee Mortgagees to execute and deliver to Tenant a subordination agreement that is in recordable form and that contains such terms as are reasonably acceptable to Tenant and Leasehold Mortgagee.

XIV. DEFAULT; REMEDIES

Section 14.01 Events of Default. Each of the following events shall be an event of default ("**Event of Default**"):

- (a) If Tenant shall fail to pay any item of Rent, or any part thereof, when the same shall become due and payable and such failure shall continue for thirty (30) days after notice from Landlord to Tenant.

- (b) If: (i) Commencement of Construction shall not have occurred on or before the Construction Commencement Date (subject to Section 30 11) and such failure shall continue for one hundred and eighty (180) days after notice from Landlord to Tenant; or (ii) Substantial Completion of the Facility shall not have occurred on or before the Completion Date (subject to Section 30 10) and such failure shall continue for one hundred and eighty (180) days after notice from Landlord to Tenant.
- (c) If Tenant shall fail to observe or perform one or more of the other terms, conditions, covenants, or agreements contained in this Lease, and such failure shall continue for a period of forty-five (45) days after written notice thereof by Landlord to Tenant specifying such failure unless such failure requires work to be performed, acts to be done, or conditions to be removed which cannot by their nature or because of Force Majeure Events reasonably be performed, done, or removed, as the case may be, within such forty-five (45) day period, in which case no Event of Default shall be deemed to exist as long as Tenant shall have commenced curing the same within such forty-five (45) day period and shall, subject to Section 30 10, diligently, continuously, and in good faith prosecute the same to completion.
- (d) If Tenant shall make an assignment for the benefit of creditors.
- (e) The filing of any voluntary petition in bankruptcy by Tenant, or the filing of any involuntary petition by Tenant's creditors, which involuntary petition remains undischarged for a period of ninety (90) days.
- (f) If within ninety (90) days after the commencement of any proceeding against Tenant seeking any reorganization, arrangement, composition, readjustment, liquidation, dissolution, or similar relief under any present or future statute, law, or regulation, such proceeding shall not have been dismissed.
- (g) If Tenant shall abandon the Premises for greater than thirty (30) days; however, Tenant shall not be deemed to have abandoned the Premises if the Premises become uninhabitable as a result of Landlord's default under this Lease or as a result of a casualty or condemnation proceeding.
- (h) If a levy under execution or attachment shall be made against the Premises and such execution or attachment shall not be vacated or removed by court order, bonding, or otherwise within a period of sixty (60) days.
- (i) Upon the occurrence of an Event of Default, Landlord may, at its option, give notice to Tenant of the termination of this Lease and, upon ninety (90) days after service of such notice, this Lease, the Term, and subject to the rights of Leasehold Mortgagee contained in this Lease, Tenant's estate shall terminate (whether or not the Commencement Date shall have occurred) and shall end with the same force and effect as if that day were the day fixed for the expiration of this Lease. Notwithstanding the foregoing, Tenant shall remain liable for any damages as provided in this Lease and Landlord may enforce any of the remedies provided in Section 14 02.

Section 14.02 Remedies. If this Lease is terminated pursuant to Section 14 01, or if Landlord re-enters or obtains possession of the Premises by summary proceedings or any other legal action or proceeding or by any other legal act (without liability or obligation to Tenant or any Subtenant or any other occupant of the Premises), all of the following provisions shall apply:

- (a) Tenant shall immediately vacate and surrender the Premises to Landlord in good order, condition, and repair, reasonable wear and tear and damage that Tenant is not obligated under the terms of this Lease to repair excepted.
- (b) Tenant shall promptly pay to Landlord all Rent payable to the date on which this Lease is terminated or the date on which Landlord re-enters or obtains possession of the Premises.
- (c) Tenant shall be liable for and shall pay to Landlord, as damages, any deficiency (referred to as "**Deficiency**") between the Rent reserved in this Lease for the period which otherwise would have constituted the unexpired portion of the Term and the net amount, if any, of rents collected under any reletting for any part of such period (first deducting from the rents collected under any such reletting all of the payments to which Landlord is entitled pursuant to Section 14 02(e)).
- (d) Landlord may (i) complete all construction required to be performed by Tenant hereunder; (ii) repair and alter the Premises in such manner as Landlord may deem reasonably necessary or advisable (and may apply to the foregoing all funds, if any, then held by Depository pursuant to this Lease without relieving Tenant of any liability under this Lease or otherwise affecting any such liability); (iii) let or relet the Premises or any parts thereof for the whole or any part of the remainder of the Term or for a longer period, in Landlord's name or as agent of Tenant, and out of any rent and other sums collected or received as a result of such reletting Landlord shall. (A) first, pay to itself the reasonable cost and expense of terminating this Lease, re-entering, retaking, repossessing, completing construction, and repairing or altering the Premises, or any part thereof, and the cost and expense of removing all persons and property therefrom, including in such costs brokerage commissions, legal expenses, and reasonable attorneys' fees and disbursements; (B) second, pay to itself the reasonable cost and expense sustained in securing any new tenants and other occupants, including in such costs brokerage commissions, legal expenses, reasonable attorneys' fees and disbursements, and other expenses of preparing the Premises for reletting, and, if Landlord shall maintain and operate the Premises, the reasonable cost and expense of operating and maintaining the Premises; and (C) third, pay to itself any balance remaining on account of the liability of Tenant to Landlord. Landlord in no way shall be responsible or liable for any failure to relet the Premises or any part thereof, or for any failure to collect any rent due on any such reletting, and no such failure to relet or to collect rent shall operate to relieve Tenant of any liability under this Lease or to otherwise affect any such liability
- (e) Landlord may elect to proceed by appropriate judicial proceedings, either at law or in equity, to enforce the performance or observance by Tenant of the applicable provisions of this Lease or to recover damages for breach thereof. Each right and remedy of

Landlord provided for in this Lease shall be cumulative and shall be in addition to every other right or remedy provided for in this Lease or now or hereafter existing at law or in equity or by statute or otherwise, and the exercise or beginning of the exercise by Landlord of any one or more of the rights or remedies provided for in this Lease or now or hereafter existing at law or in equity or by statute or otherwise shall not preclude the simultaneous or later exercise by Landlord of any or all other rights or remedies provided for in this Lease or now or hereafter existing at law or in equity or by statute or otherwise.

XV. EXPIRATION OR TERMINATION

Section 15.01 Extinguishment of Tenant's Rights. Upon the termination or expiration of this Lease from any cause, all rights and interests of Tenant, and all persons whomsoever claiming by, through, or under Tenant (with the exception of the rights of Leasehold Mortgagees arising under Article XIII and the rights of Landlord arising under Section 14 02), shall immediately cease and terminate, and the Premises, and all Improvements, located thereon, shall thence forward constitute and belong to and be the absolute property of Landlord or Landlord's successors and assigns, without further act or conveyance, and without liability to make such compensation to Tenant or to anyone whomsoever, and free and discharged from all and every lien, encumbrance, claim, and charge of any character created or attempted to be created by Tenant at any time. Tenant agrees, at the termination of this Lease, to surrender unto Landlord, all and singular the Premises with the then existing Improvements constructed and located thereon and therein, in the same condition as when the construction of Improvements was completed, only natural and normal wear and tear excepted, unless Tenant shall be relieved of Tenant's obligation to repair, reconstruct, restore, or replace damaged or destroyed buildings, other structures, or improvements pursuant to Article XVI hereof.

Section 15.02 Prepaid Items Assigned. Upon the expiration of the Term of this Lease, or upon the prior termination of this Lease from any cause, all expense items prepaid by Tenant with respect to constructing, operating, maintaining, and protecting the Premises, including, but not limited to, prepaid insurance premiums, any tax and utility deposits, shall inure to the benefit of and become the property of Landlord, and to this extent Tenant does hereby transfer, assign, and convey any such prepaid expense items to Landlord.

XVI. DAMAGE AND DESTRUCTION

Section 16.01 Damage and Destruction. If all or any part of the Premises shall be destroyed or damaged in whole or in part by fire or other casualty (including any casualty for which insurance was not obtained or obtainable) of any kind or nature, ordinary or extraordinary, foreseen or unforeseen, Tenant shall give to Landlord notice thereof within fourteen (14) days after such casualty occurs, except that no notice shall be required if the estimated cost of repairs, alterations, restorations, replacements, and rebuilding the Premises or a portion thereof so damaged or destroyed (collectively, "**Restoration**") shall be less than the Threshold Amount. Tenant shall, whether or not such damage or destruction shall have been insured, and whether or not the insurance proceeds, if any, shall be sufficient for the purpose of such Restoration, with reasonable diligence (subject to Section 30 11) repair, alter, restore, replace, and rebuild the Premises or

portion thereof so damaged or destroyed (collectively, "**Restore**") the same, at least to the extent of the value and as nearly as possible to the condition, quality and class of the Premises existing immediately prior to such occurrence. Landlord in no event shall be obligated to Restore the Premises or any portion thereof or to pay any of the costs or expenses thereof. If Tenant shall fail or neglect to Restore with reasonable diligence (subject to Section 30 11) the Premises or the portion thereof so damaged or destroyed, or having so commenced such Restoration, shall fail to complete the same with reasonable diligence (subject to Section 30 11) in accordance with the terms of this Lease, and in either case such failure or neglect continues for eighteen (18) months after notice from Landlord, or if prior to the completion of any such Restoration by Tenant, this Lease shall expire or be terminated for any reason, Landlord, upon notice to Tenant, may, but shall not be required to, complete such Restoration.

Section 16.02 Restoration Funds.

- (a) Subject to the provisions of this Article XVI, Depository shall pay over to Tenant from time to time, upon the following terms, any monies which may be received by Depository from insurance provided by Tenant (other than business interruption insurance) or cash or the proceeds of any security deposited with Depository (collectively, the "**Restoration Funds**"); provided, however, that Depository, before paying such moneys over to Tenant, shall be entitled to reimburse itself, Landlord, and Leasehold Mortgagee therefrom to the extent, if any, of the necessary, reasonable, and proper expenses (including, without limitation, reasonable attorneys' fees) paid or incurred by Depository, Landlord, and Leasehold Mortgagee in the collection of such monies. Depository shall pay to Tenant, as hereinafter provided, the Restoration Funds, for the purpose of the Restoration.
- (b) Prior to commencing any Restoration, Tenant shall furnish Landlord with an estimate of the cost of such Restoration, prepared by a licensed professional engineer or registered architect selected by Tenant. Landlord may engage a licensed professional engineer or registered architect to prepare its own estimate of the cost of such Restoration.
- (c) Subject to the provisions of this Article XVI, the Restoration Funds shall be paid to Tenant in installments as the Restoration progresses, less retainage equal to ten percent (10%) of such installment until completion of eighty percent (80%) of the Restoration and five percent (5%) of each installment thereafter until completion of the Restoration, upon application to be submitted by Tenant to Depository and, for information only, to Landlord, showing the cost of labor and materials purchased and delivered to the Premises for incorporation in the Restoration, or incorporated therein since the last previous application, and due and payable or paid by Tenant. If any vendor's, mechanic's, laborer's, or materialman's lien is filed against the Premises or any part thereof, or if any public improvement lien relating to the Restoration of the Premises is created or permitted to be created by Tenant and is filed against Landlord, or any assets of, or funds appropriated to, Landlord, Tenant shall not be entitled to receive any further installment until such lien is satisfied or discharged (by bonding or otherwise). Notwithstanding the foregoing, the existence of any such lien shall not preclude Tenant from receiving any installment of Restoration Funds, provided: (i) such lien will be discharged with funds from such installment; or (ii) if Depository shall be holding funds for the Restoration. (A) Depository certifies that it is retaining, in addition to amounts required to be retained hereunder, an amount equal to the funds required to satisfy or discharge such lien, and (B) failure to pay or discharge such lien will not result in the imminent loss or forfeiture of the Premises or

the termination of Tenant's interest under this Lease and will not subject Tenant or Landlord to any civil or criminal penalty or liability.

- (d) Upon completion of and payment for the Restoration by Tenant, the balance of the Restoration Funds shall be paid over to Tenant.
- (e) Notwithstanding the foregoing, if Landlord makes the Restoration at Tenant's expense, as provided in Section 16 01 hereof, then Depository shall pay over the Restoration Funds to Landlord, upon request, to the extent not previously paid to Tenant pursuant to this Article XVI, and Tenant shall pay to Landlord, within fourteen (14) Business Days after demand, any sums in excess of the portion of the Restoration Funds received by Landlord necessary to complete the Restoration.

Section 16.03 Restoration Costs that Exceed the Threshold Amount. If any loss, damage, or destruction occurs, the cost of Restoration of which equals or exceeds the Threshold Amount in the aggregate, in addition to the other requirements contained in this Article XVI, Tenant shall furnish to Landlord the documents and shall comply with the requirements set forth in Section 7.05 through Section 7 15 of this Lease as required for the initial construction of the Facility

Section 16.04 Excess Costs of Restoration. If the cost of any Restoration, determined as provided in Section 16 02, exceeds both. (a) the Threshold Amount; and (b) the net insurance proceeds, then, prior to the commencement of such Restoration, Tenant shall deposit with Depository, as security for completion of the Restoration, a bond, cash, or other security reasonably satisfactory to Landlord in the amount of such excess, to be held and applied by Depository in accordance with the provisions of Section 12.02.

Section 16.05 No Termination; No Abatement. This Lease shall not terminate, be forfeited, or be affected in any manner, and there shall be no reduction or abatement of the Rent, by reason of damage to or total, substantial, or partial destruction of the Premises or any part thereof or by reason of the untenability of the same or any part thereof, for or due to any reason or cause whatsoever, and Tenant, notwithstanding any Law, waives any and all rights to quit or surrender the Premises or any part thereof. Tenant expressly agrees that its obligations hereunder, including the payment of Rent, shall continue as though the Premises had not been damaged or destroyed and without abatement, suspension, diminution, or reduction of any kind.

XVII. CONDEMNATION

Section 17.01 Total Taking.

- (a) If all or substantially all of the Premises shall be taken for any public or quasi-public purpose by any lawful power or authority by the exercise of the right of condemnation, eminent domain, or by agreement among Landlord, Tenant, and those authorized to exercise such right, the Term shall terminate on the Date of Taking and the Rent payable by Tenant hereunder shall be equitably apportioned as of the date of such taking.
- (b) If all or substantially all of the Premises shall be taken or condemned by an entity other than the Landlord as provided in Section 17 01(a), the award, awards, or damages in

respect thereof shall be apportioned as follows: (i) there shall first be paid to Leasehold Mortgagee so much of the balance of such award as shall equal the unpaid principal indebtedness secured by such Leasehold Mortgage with interest thereon at the rate specified therein to the date of payment (such payments to be made in order of lien priority and on equal footing to Leasehold Mortgagee with liens of the same priority); (ii) there shall next be paid (subject to rights of any Leasehold Mortgagee), to Tenant shall receive the balance of the award which is for or attributable to the value of the Improvements; (iii) there shall next be paid to Landlord so much of the award which is for or attributable to the Land Value; and (iv) the balance, if any, shall be received by Tenant for furtherance of its charitable purpose.

- (c) Each of the parties shall execute any and all documents that may be reasonably required in order to facilitate collection by them of such awards.

Section 17.02 Partial Taking. If less than substantially all of the Premises shall be so taken, this Lease and the Term shall continue as to the portion of the Premises remaining without diminution of any of Tenant's obligations hereunder. If not impractical, Tenant shall proceed diligently to Restore any remaining part of the Premises not so taken so that the latter shall be a complete, operable, and self-contained architectural unit in good condition and repair in conformity with this Land. In the event of any taking pursuant to this Section 17.02, the entire award for or attributable to the Land taken and the Land Value thereof, shall be first paid to Landlord, and the balance of the award, if any, shall be paid to Depository, except that if such balance shall be less than the Threshold Amount, such balance shall be payable, in trust, to Tenant for application to the cost of Restoration of the part of the Premises not so taken. Subject to the provisions and limitations in this Article XVII, Depository shall make available to Tenant as much of that portion of the award actually received and held by Depository, if any, less all necessary and proper expenses paid or incurred by Depository, Leasehold Mortgagee most senior in lien, and Landlord in the condemnation proceedings, as may be necessary to pay the cost of Restoration of the part of the Premises remaining. Such Restoration shall be done in accordance with and subject to the provisions of Article XVI. Payments to Tenant as aforesaid shall be disbursed in the manner and subject to the conditions set forth in Article XVI. Any balance of the award held by Depository and any cash and the proceeds of any security deposited with Depository remaining after completion of the Restoration shall be paid to Tenant. Each of the parties shall execute any and all documents that may be reasonably required in order to facilitate collection by them of such awards.

Section 17.03 Depository. With respect to any Restoration required by the terms of Section 17.02, the cost of which, as determined in the manner set forth in Section 16.02(b), exceeds both: (a) the Threshold Amount; and (b) the balance of the condemnation award after payment of the expenses set forth in Section 17.02, then, prior to the commencement of such Restoration, Tenant shall deposit with Depository a bond, cash, or other security reasonably satisfactory to Landlord in the amount of such excess, to be held and applied by Depository in accordance with the provisions of Section 17.02, as security for the completion of the Restoration.

Section 17.04 Temporary Taking. If the temporary use of the whole or any part of the Premises shall be taken for any public or quasi-public purpose by any lawful power or authority by the exercise of the right of condemnation or eminent domain or by agreement between Tenant

and those authorized to exercise such right, Tenant shall give prompt notice thereof to Landlord, the Term shall not be reduced or affected in any way, Tenant shall continue to pay in full the Rent payable by Tenant hereunder without reduction or abatement, and Tenant shall be entitled to receive for itself any award or payments for such use; provided, however, that:

- (a) If the taking is for a period not extending beyond the Term and if such award or payment is made less frequently than in monthly installments, the same shall be paid to and held by Depository as a fund which Depository shall apply from time to time to the payment of Rent, except that, if such taking results in changes or alterations in the Premises which would necessitate an expenditure to Restore the Premises to their former condition, then, a portion of such award or payment considered by Landlord, in its reasonable opinion, as appropriate to cover the expenses of the Restoration shall be retained by Depository, without application as aforesaid, and applied and paid over toward the Restoration of the Premises to their former condition, substantially in the same manner and subject to the same conditions as provided in Section 17 02, and any portion of such award or payment which shall not be required pursuant to this Section 17 04(a) to be applied to the Restoration of the Building or to the payment of Rent until the end of the Term (or, if the taking is for a period terminating prior to the end of the Term, until the end of such period), shall be paid to Tenant.
- (b) If the taking is for a period extending beyond the Term, such award or payment shall be apportioned between Landlord and Tenant as of the Expiration Date, and Landlord's and Tenant's share thereof, if paid less frequently than in monthly installments, shall be paid to Depository and applied in accordance with the provisions of this Section 17 04, provided, however, that the amount of any award or payment allowed or retained for the Restoration of the Premises and not previously applied for such purpose shall remain the property of Landlord if this Lease shall expire prior to such Restoration.

Section 17.05 Negotiated Sale in Lieu of Condemnation. In the event of a negotiated sale of all or a portion of the Premises in lieu of condemnation, the proceeds shall be distributed as provided in cases of condemnation.

Section 17.06 Participation in Condemnation Proceeding. Landlord, Tenant, and any Leasehold Mortgagee shall be entitled to file a claim and otherwise participate in any condemnation or similar proceeding and all hearings, trials, and appeals in respect thereof.

Section 17.07 Rights of Tenant and Subtenants to File Claims. Notwithstanding anything to the contrary contained in this Article XVII, in the event of any permanent or temporary taking of all or any part of the Premises, Tenant and its Subtenants shall have the exclusive right to assert claims for any trade fixtures and personal property so taken which were the property of Tenant or its Subtenants and for relocation expenses of Tenant or its Subtenants, all awards and damages in respect thereof shall belong to Tenant and its Subtenants, and Landlord hereby waives any and all claims to any part thereof; provided, however, that if there shall be no separate award or allocation for such trade fixtures or personal property, then such claims of Tenant and its Subtenants, or awards and damages, shall be subject and subordinate to Landlord's claims under this Article XVII.

XVIII. RESERVED

XIX. NOTICES

Section 19.01 Notices. Until a different address is provided in a notice to the other party, all notices, demands, or requests made by either party to the other which are required or permitted by the provisions of this Lease shall be in writing and shall be deemed sufficiently given if: (a) delivered by hand (against a signed receipt); (b) mailed by United States certified or registered mail, return receipt requested, postage prepaid; or (c) sent by a nationally recognized commercial overnight delivery service to the following addresses:

Landlord: City Manager, 200 N. David St., Casper, WY 82609
with a copy to: Director of Public Facilities, 200 N David St., Casper, WY 82609
Tenant: Wyo Complex, 441 Landmark Drive, Suite 100, Casper, WY 82609

Leasehold Mortgagee: TO BE DETERMINED AFTER WRITTEN NOTICE

Notwithstanding anything contained in this Lease to the contrary, any notice required to be given by Landlord or Tenant hereunder shall be deemed to be effective as of the date such notice is received or refused as reflected on said notice.

XX. SUBMISSION OF MATTERS TO LANDLORD FOR APPROVAL

Section 20.01 Submission of Matters to Landlord for Approval. Any matter which must be submitted to and consented to or approved in writing by Landlord or any matter which must be submitted to Landlord which may become effective if not denied by Landlord, as required under this Lease, shall be submitted to Landlord in the manner and to the address of Landlord designated for the giving of notice to Landlord under Article XIX of this Lease and shall either be approved or rejected by Landlord within sixty (60) days after receipt unless a shorter period of time is expressly stated elsewhere in this Lease. If Landlord should fail so to approve or reject within such sixty (60)-day period as provided for herein, Landlord's approval shall be deemed rejected. Upon Tenant's written request, Landlord shall inform Tenant in writing of its rejection or approval of such submitted matter in the manner and to the address of Tenant designated for the giving of notice to Tenant under Article XIX of this Lease. Any review by Landlord of any matter submitted to Landlord is for Landlord's own convenience and purpose only. By undertaking such review, Landlord does not obtain or have any liability to Tenant or any other person, including, without limitation, the insurers and lenders of Tenant.

XXI. HOLDING OVER

Section 21.01 Holding Over by Tenant. Tenant shall not use or remain in possession of the Premises after the termination of this Lease. Any holding over, or continued use or occupancy

by Tenant after the termination of this Lease, without the written consent of Landlord, shall not constitute a tenant-at-will interest on behalf of Tenant, but Tenant shall become a tenant-at-sufferance and liable for Rent and all other expenses, obligations, and payments in effect for the immediately preceding year of the Term of this Lease. There shall be no renewal whatsoever of this Lease by operation of Law

XXII. COMPLIANCE WITH LAWS; ENVIRONMENTAL LAWS

Section 22.01 Compliance with Laws. Tenant warrants and agrees that, during the entire Term of this Lease and at its expense (a) Tenant will conduct Tenant's business and activities on or related to the Premises only in full compliance with all applicable Laws; (b) Tenant will neither do nor permit any act or omission which could cause the Premises and Tenant's use thereof to fail to be in full compliance with all applicable Laws; and (c) Tenant will neither do nor permit any act or omission which could cause any Liabilities to exist or be asserted against Landlord or the Premises. Without limiting the foregoing, Tenant shall promptly cure all violations of Law for which Tenant has received notice or a public notice of violation has been issued and pay all fines, penalties, interest, or other costs imposed by any Governmental Authorities in connection with any violation or requirement of any Law

Section 22.02 Environmental Laws.

- (a) Tenant warrants and agrees that, during the entire Term of this Lease and at its expense, Tenant shall comply with all Environmental Laws. Such compliance shall include Tenant's obligation to take Remedial Action when required by Law and to pay all fines, penalties, interest, or other costs imposed by any Governmental Authorities in connection with any violation or requirement of any Law
- (b) Tenant shall notify Landlord promptly in writing if: (i) Tenant becomes aware of the presence or Release of any Hazardous Material at, on, under, over, emanating from, or migrating to the Premises in any quantity or manner which could reasonably be expected to violate, in any material respect, any Environmental Law or give rise to any material Liability or the obligation to take Remedial Action; or (ii) Tenant receives any written notice, claim, demand, request for information, or other communication from a Governmental Authority regarding the presence or Release of any Hazardous Material at, on, under, over, emanating from, or migrating to the Premises.
- (c) Tenant shall take and complete any Remedial Action with respect to the Premises in full compliance with all Laws and shall, when such Remedial Action is completed, submit to Landlord written confirmation from the applicable Governmental Authority that no further Remedial Action is required.
- (d) Tenant shall provide Landlord with copies of all tests, studies, notices, claims, demands, requests for information, or other communications relating to the

presence or Release of any Hazardous Materials at, on, under, over, emanating from, or migrating to the Premises.

XXIII. BROKERS

Section 23.01 Brokers. Tenant shall indemnify and hold harmless the Landlord from and against any and all claims for any brokerage fee or commission with respect to this Lease transaction by any broker with whom the Tenant has dealt or is alleged to have dealt. The provisions of this Section 23 01 shall survive any termination of this Lease.

XXIV. NO IMPAIRMENT OF LANDLORD'S TITLE

Section 24.01 No Impairment of Landlord's Title. Tenant shall not permit the Premises to be used by any Person at any time or times during the Term of this Lease in such a manner as would impair Landlord's title to or interest in the Premises or in such a manner as would cause a claim or claims of adverse possession, adverse use, prescription, or other similar claims of, in, to, or with respect to the Premises.

XXV. QUIET ENJOYMENT

Section 25.01 Quiet Enjoyment. Landlord covenants and agrees that, if and so long as Tenant observes and performs each and every covenant, agreement, provision, and condition of this Lease on the part of Tenant to be observed and performed throughout the Term of this Lease, Tenant may peaceably and quietly enjoy the Premises without hindrance or molestation of Landlord or any Person acting through Landlord.

XXVI. LIMITATION OF LANDLORD'S LIABILITY

Section 26.01 Limitation of Landlord's Liability.

- (a) If Landlord sells, assigns, or otherwise transfers (whether by operation of Law or otherwise) all or part of its interests in the Premises or this Lease: (i) Landlord shall be relieved of all obligations and Liabilities of Landlord under this Lease accruing after the effective date of such transfer; and (ii) the transferee shall be deemed to have assumed all of Landlord's obligations and Liabilities under this Lease effective from and after the effective date of the transfer.
- (b) Landlord shall have no personal liability whatsoever under or in connection with this Lease without distinction as to the person whose negligence is responsible for any damage or injury hereunder. Tenant agrees that it shall look solely to Landlord's interest in the Premises and this Lease for the satisfaction of Tenant's remedies or to collect any judgment requiring payment of any money by Landlord.

XXVII. RESERVED

XXVIII. RECORDING

Section 28.01 Recording. As soon as practical, but no later than seven (7) days after the execution of this Lease, the Tenant shall record this Lease in the Natrona County Clerk's office in Casper, Wyoming at the Tenant's sole cost and expense, and provide a certified copy to the Landlord for its records.

XXIX. EXTENSION OPTIONS

Section 29.01 Option to Extend. Provided no Event of Default shall have occurred and be continuing at the time of exercise or at the expiration of the Term or, if applicable, the immediately preceding extension period of the Term, Tenant shall have two (2) options to extend the Term of the Lease, each for a period of fifteen (15) years under the same terms and provisions of this Lease then in effect (each such additional term being referred to as an "**Extension Term**" and each such option being referred to as an "**Extension Option**").

Section 29.02 Terms of Extension. Tenant shall exercise an extension option by giving notice to Landlord of Tenant's intention to do so not more than three hundred sixty-five (365) days or less than ninety (90) days prior to the expiration of the Lease Term or the then applicable Extension Term (the "**Extension Notice**").

Section 29.03 Failure to Exercise. If Tenant fails to timely notify Landlord of its election to exercise its extension option in the manner set forth above, this Lease shall terminate on the last day of the Lease Term or, if applicable, the last day of the then applicable extension of the Lease Term.

XXX. MISCELLANEOUS

Section 30.01 Landlord and Tenant Representations and Warranties. Landlord and Tenant each represent and warrant that:

- (a) This Lease has been duly authorized, executed, and delivered by such party and constitutes the legal, valid, and binding obligation of such party
- (b) There are no actions, suits, or proceedings pending or, to the knowledge of such party, threatened against or affecting such party, at law or at equity or before any Governmental Authority that would impair such party's ability to perform its obligations under this Lease.
- (c) The consummation of the transactions hereby contemplated and the performance of this Lease will not result in any breach or violation of, or constitute a default under, any lease or financing agreement.

Tenant agrees that, if it is not an individual, it shall provide to Landlord, upon Landlord's request, evidence that the execution and delivery of this Lease have been duly authorized by Tenant.

Section 30.02 No Waiver; Cumulative Rights of Landlord.

- (a) No failure of Landlord to exercise any power given Landlord hereunder or to insist upon strict compliance by Tenant with its undertakings, duties, and obligations hereunder, and no custom or practice of the parties hereto at variance with the provisions hereof shall constitute a waiver of Landlord's right to demand exact compliance with the provisions contained in this Lease.
- (b) All rights, powers, and privileges conferred herein upon both parties hereto are cumulative and are in addition to and not in substitution for any other rights and remedies available at law, in equity, or otherwise.

Section 30.03 Provisions Are Binding Upon Successors and Assigns. It is mutually covenanted, understood, and agreed by and between the parties hereto, that each of the provisions of this Lease shall apply to, extend to, be binding upon, and inure to the benefit or detriment of not only the parties hereto, but also the legal representatives, successors, and assigns of Landlord and Tenant, and shall be deemed and treated as covenants running with the Premises during the term of this Lease. Whenever a reference to the parties hereto is made, such reference shall be deemed to include the legal representatives, successors, and assigns of said party, the same as if in each case expressed.

Section 30.04 Applicable Law. This Lease shall be governed, construed, performed, and enforced in accordance with the Laws of the State of Wyoming.

Section 30.05 Reserved.

Section 30.06 Interpretation and Construction. This Lease shall be construed without regard to any presumption or rule requiring construction or interpretation against the party drafting an instrument or causing any instrument to be drafted. Any captions or headings used in this Lease are for convenience only and do not define or limit the scope of this Lease. The singular of any term, including any defined term, shall include the plural and the plural of any term shall include the singular. Whenever the singular or plural number, or masculine or feminine gender is used in this Lease, it shall equally apply to, extend to, and include the other.

Section 30.07 Severability. If any term of this Lease is to any extent illegal, otherwise invalid, or incapable of being enforced, such term shall be excluded to the extent of such invalidity or unenforceability; all other terms hereof shall remain in full force and effect; and, to the extent permitted and possible, the invalid or unenforceable term shall be deemed replaced by a term that is valid and enforceable and that comes closest to expressing the intention of such invalid or unenforceable term. If application of this Severability provision should materially and adversely affect the economic substance of the transactions contemplated hereby, the Party adversely impacted shall be entitled to compensation for such adverse impact, provided the reason for the invalidity or unenforceability of a term is not due to serious misconduct by the Party seeking such compensation.

Section 30.08 Reserved.

Section 30.09 Time Is of the Essence. All time limits stated in this Lease are of the essence of this Lease.

Section 30.10 Patriot Act.

(a) Tenant hereby represents and warrants to Landlord that Tenant: (i) is in compliance with the Office of Foreign Assets Control sanctions and regulations promulgated under the authority granted by the Trading with the Enemy Act, 12 U.S.C. § 95(a) *et seq.*, and the International Emergency Economic Powers Act, 50 U.S.C. § 1701 *et seq.*, as the same apply to it or its activities; (ii) is in compliance with the Uniting and Strengthening America by Providing Appropriate Tools Required to Intercept and Obstruct Terrorism Act of 2001, as amended from time to time (the "**Patriot Act**") and all rules and regulations promulgated under the Patriot Act applicable to Tenant; and (iii) (A) is not now, nor has ever been, under investigation by any governmental authority for, nor has been charged with or convicted of a crime under, 18 U.S.C. §§ 1956 or 1957 or any predicate offense thereunder; (B) has never been assessed a civil penalty under any anti-money laundering laws or predicate offenses thereunder; (C) has not had any of its funds seized, frozen, or forfeited in any action relating to any anti-money laundering laws or predicate offenses thereunder; (D) has taken such steps and implemented such policies as are reasonably necessary to ensure that it is not promoting, facilitating, or otherwise furthering, intentionally or unintentionally, the transfer, deposit, or withdrawal of criminally derived property, or of money or monetary instruments which are (or which Tenant suspects or has reason to believe are) the proceeds of any illegal activity or which are intended to be used to promote or further any illegal activity; and (E) has taken such steps and implemented such policies as are reasonably necessary to ensure that it is in compliance with all Laws and regulations applicable to its business for the prevention of money laundering and with anti-terrorism Laws and regulations, with respect both to the source of funds from its investors and from its operations, and that such steps include the development and implementation of an anti-money laundering compliance program within the meaning of Section 352 of the Patriot Act, to the extent such a party is required to develop such a program under the rules and regulations promulgated pursuant to Section 352 of the Patriot Act. Neither Tenant nor any other person owning a direct or indirect, legal, or beneficial interest in Tenant is in violation of the Executive Order or the Patriot Act. Neither Tenant nor any of its respective constituents, investors (direct or indirect and whether or not holding a legal or beneficial interest), or Affiliates, acting or benefiting, directly or indirectly, in any capacity in connection with the Landlord and/or the Building Complex, this Agreement, or any of the transactions contemplated hereby or thereby, is: (w) listed in the Annex to, or otherwise subject to the provisions of, that certain Executive Order No. 13224 on Terrorist Financing, effective September 24, 2001, and relating to Blocking Property and Prohibiting Transactions With Persons Who Commit, Threaten to Commit, or Support Terrorism (the "**Executive Order**"); (x) named as a "specifically designated national (SDN)" on the most current list published by the U S Treasury Department Office of Foreign Assets Control at its official website (<http://www.treas.gov/ofac/t11sdn.pdf>) or at any replacement website or other replacement official publication of such list or that is named on any other Governmental Authority list issued post 9/11/01; (y) acting, directly or indirectly

for terrorist organizations or narcotics traffickers, including those persons that are included on any relevant lists maintained by the United Nations, North Atlantic Treaty Organization, Financial Action Task Force on Money Laundering, U.S. Office of Foreign Assets Control, U.S. Securities and Exchange Commission, U.S. Federal Bureau of Investigation, U.S. Central Intelligence Agency, U.S. Internal Revenue Service, all as may be amended or superseded from time to time, or (z) owned or controlled by, or acting for or on behalf of, any person described in clauses (w), (x), or (y) above (a "**Prohibited Person**"). None of the funds or other assets of Tenant constitute property of, or are beneficially owned, directly or indirectly, by any person, entity, or government subject to trade restrictions under U.S. Law, including but not limited to (1) the International Emergency Economic Powers Act, 50 U.S.C. §§ 1701 *et seq.*, (2) The Trading with the Enemy Act, 50 U.S.C. App 1 *et seq.*, and (3) any Executive Orders or regulations promulgated thereunder, with the result that sale by Tenant or other Persons (whether directly or indirectly), is prohibited by law (an "**Embargoed Person**"). No Embargoed Person has any interest of any nature whatsoever in Tenant (whether directly or indirectly) and none of the funds of Tenant have been derived from any unlawful activity with the result that an investment in Tenant (whether directly or indirectly) or sale by Tenant, is prohibited by Law or that execution, delivery, and performance of this Lease or any of the transactions or other documents contemplated hereby or thereby is in violation of Law.

- (b) Landlord hereby represents and warrants to Tenant that Landlord: (i) is in compliance with Patriot Act and all rules and regulations promulgated under the Patriot Act applicable to Tenant; and (ii) (A) is not now, nor has ever been, under investigation by any governmental authority for, nor has been charged with or convicted of a crime under, 18 U.S.C. §§ 1956 or 1957 or any predicate offense thereunder; (B) has never been assessed a civil penalty under any anti-money laundering laws or predicate offenses thereunder; (C) has not had any of its funds seized, frozen, or forfeited in any action relating to any anti-money laundering laws or predicate offenses thereunder; (D) has taken such steps and implemented such policies as are reasonably necessary to ensure that it is not promoting, facilitating, or otherwise furthering, intentionally or unintentionally, the transfer, deposit, or withdrawal of criminally derived property, or of money or monetary instruments which are (or which Tenant suspects or has reason to believe are) the proceeds of any illegal activity or which are intended to be used to promote or further any illegal activity; and (E) has taken such steps and implemented such policies as are reasonably necessary to ensure that it is in compliance with all Laws and regulations applicable to its business for the prevention of money laundering and with anti-terrorism Laws and regulations, with respect both to the source of funds from its investors and from its operations, and that such steps include the development and implementation of an anti-money laundering compliance program within the meaning of Section 352 of the Patriot Act, to the extent such a party is required to develop such a program under the rules and regulations promulgated pursuant to Section 352 of the Patriot Act. Neither Landlord nor any other person owning a direct or indirect, legal, or beneficial interest in Landlord is in violation of the Executive Order or the Patriot Act. Neither Landlord nor any of its respective

constituents, investors (direct or indirect and whether or not holding a legal or beneficial interest), or Affiliates, acting or benefiting, directly or indirectly, in any capacity in connection with the Landlord and/or the Building Complex, this Agreement, or any of the transactions contemplated hereby or thereby, is a Prohibited Person. None of the funds or other assets of Landlord constitute property of, or are beneficially owned, directly or indirectly, by an Embargoed Person. No Embargoed Person has any interest of any nature whatsoever in Landlord (whether directly or indirectly), and none of the funds of Landlord have been derived from any unlawful activity with the result that an investment in Landlord (whether directly or indirectly) or sale by Landlord, is prohibited by Law or that execution, delivery, and performance of this Lease or any of the transactions or other documents contemplated hereby or thereby is in violation of Law

Section 30.11 Force Majeure.

- (a) Neither party shall be liable or responsible to the other party, nor be deemed to have defaulted under or breached this Lease, for any failure or delay in fulfilling or performing any obligation under this Lease (except for any obligations to make payments to the other party hereunder), when and to the extent such failure or delay is caused by a Force Majeure Event. The failure or inability of either party to perform its obligations in this Lease due to a Force Majeure Event shall be excused for the duration of the Force Majeure Event and extended for a period equivalent to the period of such delay, but not in excess of three hundred sixty-five (365) days in the aggregate. Nothing contained in this Section shall excuse either party from paying in a timely fashion any payments due under the terms of this Lease or extend the term of this Lease. Supply chain issues that substantially impact the Schedule of Performance, specifically the critical path or milestones of construction, are Force Majeure events.
- (b) To the extent either party relies on a Force Majeure Event to delay performance of any obligation hereunder, such party (the "**Force Majeure Noticing Party**") shall give the other party notice within thirty (30) days of the commencement of the Force Majeure Event, explaining the nature or cause of the delay and stating the period of time the delay is expected to continue. The Force Majeure Noticing Party shall use diligent efforts to end the failure or delay and ensure the effects of such Force Majeure Event are minimized. The Force Majeure Noticing Party shall resume the performance of its obligations as soon as is reasonably practicable after the Force Majeure Event ends. [In the event that the failure or delay remains uncured for a period of three hundred sixty five (365) consecutive days following written notice given by the Force Majeure Noticing Party under this Section, either party may thereafter terminate this Agreement upon thirty (30) days' written notice to Noticing Party, in which event neither party thereafter shall have any further obligations under this Lease, except for those obligations which are expressly stated to survive termination or expiration of the Lease.

Section 30.12 No Agency. Nothing in this Lease is intended, or shall in any way be construed, so as to create any form of partnership or agency relationship between the parties. The

parties hereby expressly disclaim any intention of any kind to create any partnership or agency relationship between themselves. Nothing in this Lease shall be construed to make either party liable for any of the indebtedness of the other, except as specifically provided in this Lease.

Section 30.13 Entire Agreement. The making, execution, and delivery of this Lease by Tenant has not been induced by any representations, statements, covenants, or warranties by Landlord except for those contained in this Lease. This Lease constitutes the full, complete, and entire agreement between and among the parties hereto. No agent, employee, officer, representative, or attorney of the parties hereto has authority to make, or has made, any statement, agreement, representation, or contemporaneous agreement, oral or written, in connection herewith modifying, adding to, or changing the provisions of this Lease. No amendment of this Lease shall be binding unless such amendment shall be in writing, signed by both parties hereto and attached to, incorporated in, and by reference made a part of this Lease.

Section 30.14 Counterparts. This Lease may be executed in counterparts, each of which shall be deemed an original and all of which together shall constitute one and the same instrument.

Section 30.15 Governmental Claims. The Landlord does not waive any right or rights it may have pursuant to the Wyoming Governmental Claims Act, Wyoming Statutes Section 1-39-101 *et seq.*, and the Landlord specifically reserves the right to assert any and all rights, immunities, and defenses it may have pursuant to the Wyoming Governmental Claims Act.

Section 30.16 Coordination of Events, Shared Parking The Tenant, Landlord, and manager of the Ford Wyoming Center agree and understand that close coordination and cooperation will need to occur between the Tenant, Landlord, and manager of the Ford Wyoming Center to ensure that the two facilities are coordinating events. The Tenant is aware that the Ford Wyoming Center (or its successor) is built to handle large events like tournaments, concerts, and the College National Finals Rodeo. If the Tenant were to choose to host a large event at the same time, the parking situation could be untenable. Tenant, Landlord, and manager of the Ford Wyoming Center agree that they will meet monthly and annually as agreed, to coordinate events and parking to optimize the use of both facilities, and negotiate in good-faith to determine and implement alternate parking solutions as needed (e.g., shuttle bus services). The parties agree that they will closely coordinate with each other and the manager of the Ford Wyoming Center to prevent parking congestion to the extent possible. The Tenant, Landlord, and manager of the Ford Wyoming Center will keep all information **confidential** that is shared during the calendar-sharing and coordination meetings, recognizing that many events the parties may hold cannot be disclosed to the public until agreements are finalized. Tenant, Landlord, and manager of the Ford Wyoming Center understand that these discussions may be subject to the Wyoming Public Records Act, W.S. Section 16-4-201 *et seq.*, The Tenant shall not directly compete with the Ford Wyoming Center by applying to host the same events that the Landlord currently hosts unless the parties agree to jointly apply and/or host an event, or unless the parties agree in writing.

[signature page follows]

IN WITNESS WHEREOF, Landlord and Tenant have caused this Lease to be duly executed in duplicate counterparts each of which shall be deemed to be an original, the day and year first above written.

APPROVED AS TO FORM

(Landlord's Attorney)

Walker Trust

ATTEST

LANDLORD

CITY OF CASPER, WYOMING

Fleur Tremel
City Clerk

Ray Pacheco
Mayor

APPROVED AS TO FORM

(Tenant's Attorney)

Japowers

WITNESS

TENANT

WYO Complex

By: T. A. Smith

By: [Signature]

Printed Name: Timm A. Smith

Printed Name: JR Boyles

Title: _____

Title: Director

**EXHIBIT A
COVER PAGE**

WLC Engineering & Surveying Map of the Leased Premises dated March 15, 2022, and July 27, 2022.

WLC ENGINEERING & SURVEYING
 200 PRONGHORN STREET, CASPER, WYOMING 82601
 FOR

Client CASPER REDEVELOPMENT COMPANY LLC Address 441 LANDMARK DRIVE, SUITE 100
 City CASPER State WYOMING Zip 82609

EXHIBIT "A" - Page 1 of 2

S1/2NW1/4
N1/2SW1/4 Section 33, T. 34 N., R. 79 W., 6th Principal Meridian, Wyoming
 Lot A PORTION OF TRACT 4 Subdivision NORTH PLATE RIVER PARK
 City CASPER County NATRONA State WYOMING

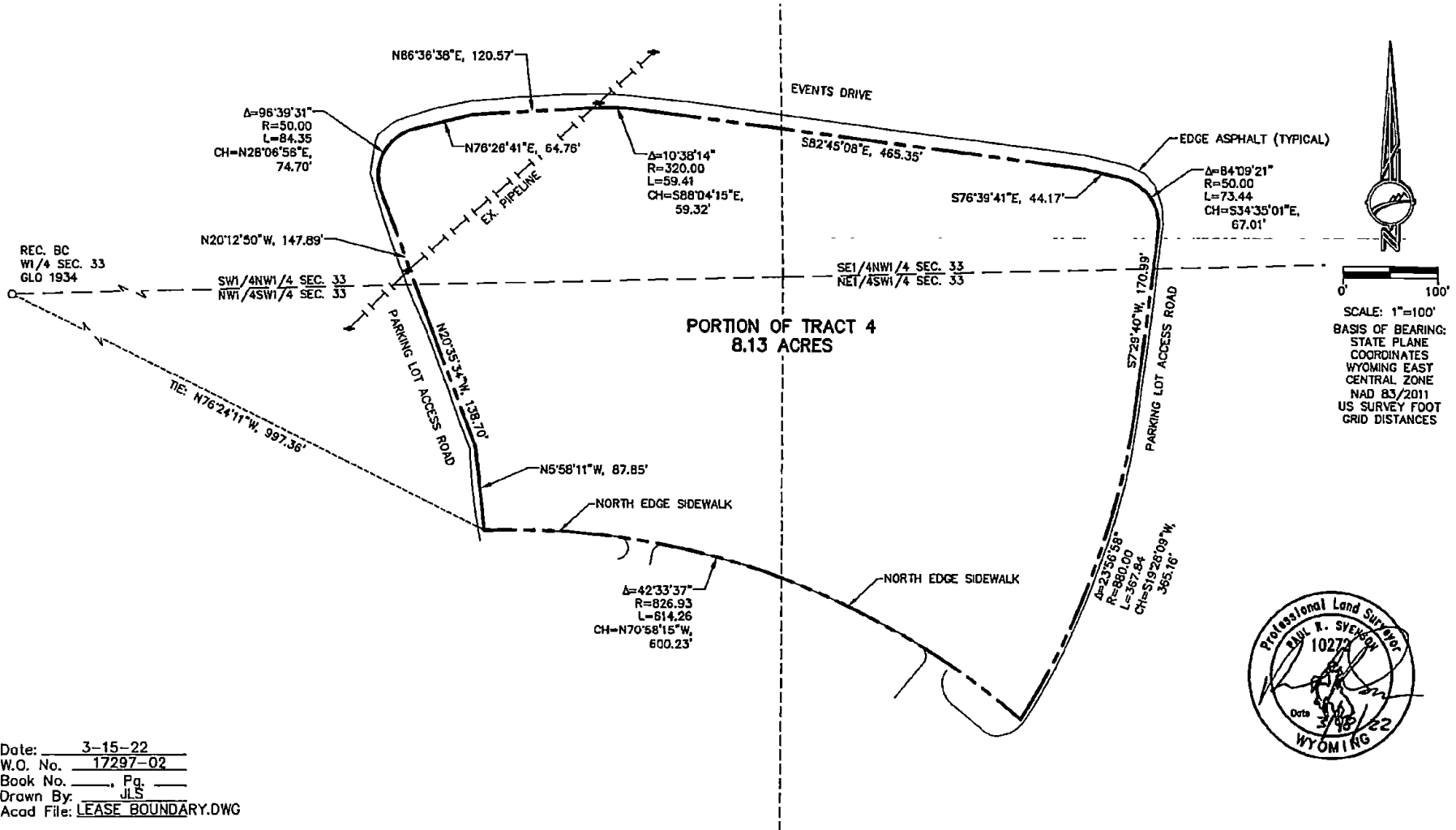

Date: 3-15-22
 W.O. No. 17297-02
 Book No. , Pg.
 Drawn By: JLS
 Acad File: LEASE_BOUNDARY.DWG

WLC ENGINEERING & SURVEYING
 200 PRONGHORN STREET, CASPER, WYOMING 82601

EXHIBIT "A" - Page 2 of 2

FOR
 Client CASPER REDEVELOPMENT COMPANY LLC Address 441 LANDMARK DRIVE, SUITE 100
 City CASPER State WYOMING Zip 82609

SW1/4NW1/4
NW1/4SW1/4 Section 33, T. 34 N., R. 79 W., 6th Principal Meridian, Wyoming
 Lot A PORTION OF TRACT 4 Subdivision NORTH PLATTE RIVER PARK
 City CASPER County NATRONA State WYOMING

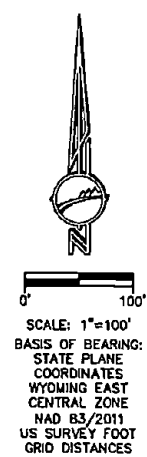
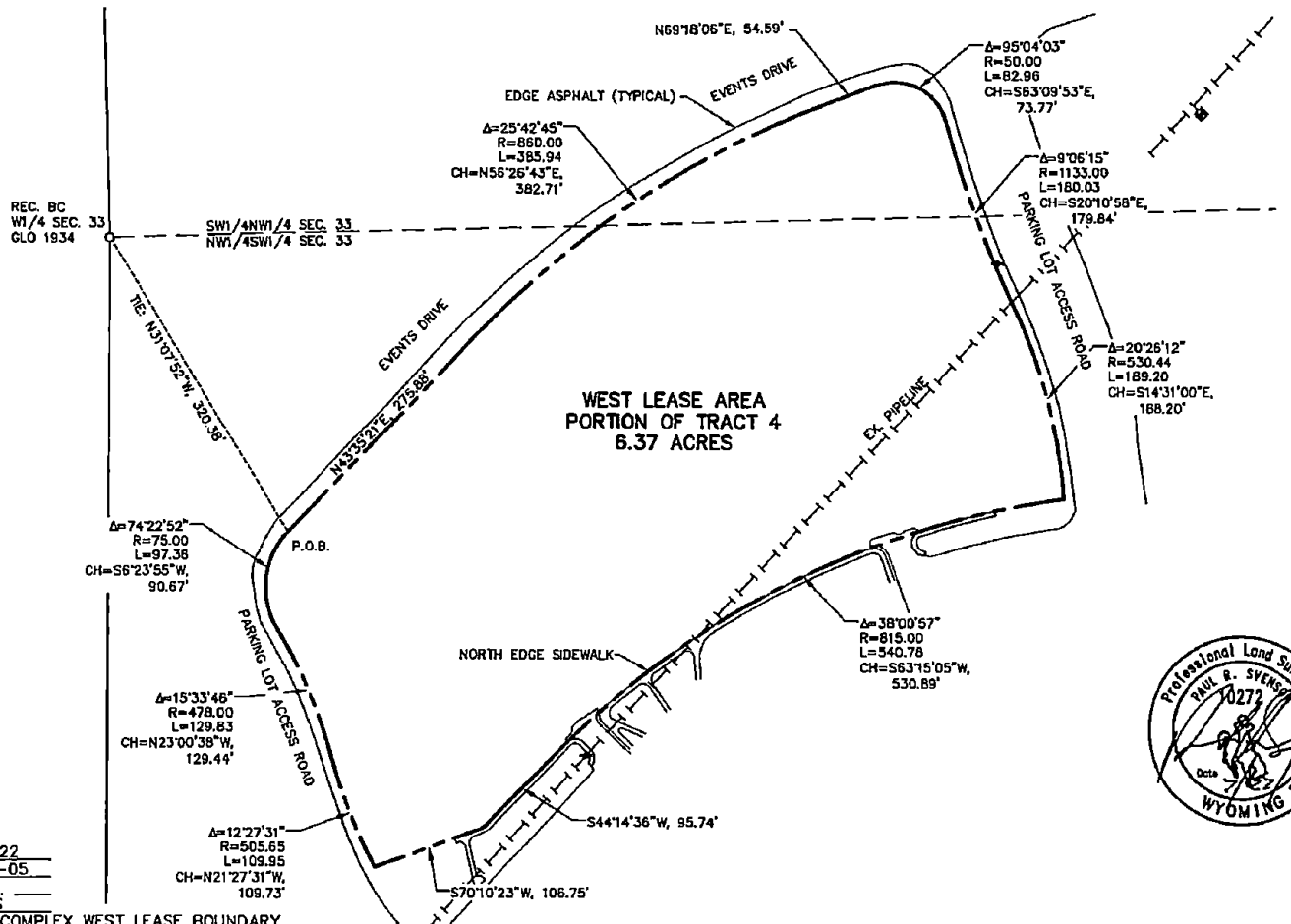

Date: 7-27-2022
 W.O. No. 17297-05
 Book No. , Pg.
 Drawn By: JLS

Acad File: SPORTS COMPLEX WEST LEASE BOUNDARY
 H:\CLIENT\STATELINE NO. 7\17297-STATELINE NO.7-CASPER SPORTS COMPLEX SURVEY\DWG\SPORTS COMPLEX WEST LEASE BOUNDARY.DWG

**EXHIBIT B
COVER PAGE**

WLC Legal Description of the Leased Premises dated March 15, 2022, and July 27, 2022.



CASPER
200 PRONGHORN
CASPER, WY 82601
P: 307-266-2524

EXHIBIT "B"
Page 1 of 2

March 15, 2022

Casper Redevelopment Company, LLC
441 Landmark Drive, Suite 100
Casper, Wyoming 82609

W.O. No.: 17297-02

Description: Portion of Tract 4, North Platte River Park Subdivision – 8.13 Acres

A Parcel located in and being a portion of Tract 4, North Platte River Park Subdivision, City of Casper, Natrona County, Wyoming, located in the S1/2NW1/4, N1/2SW1/4, Section 33, Township 34 North, Range 79 West, 6th P.M., being more particularly described by metes and bounds as follows:

Beginning at the southwest corner of the Parcel being described and from which point the W1/4 of corner of said Section 33 bears N.76°24'11"W., 997.36 feet, thence from said Point of Beginning, N5°58'11"W, 87.85 feet to a point; thence, N20°35'34"W, 138.70 feet to a point; thence, N20°12'50"W, 147.89 feet to the beginning of a curve; thence along the arc of a true curve to the right and having a radius of 50.00 feet, and the long chord of which bears N28°06'56"E, 74.70 feet, through a central angle of 96°39'30.7", 84.35 feet to a point of intersection with a tangent line; thence, N76°26'41"E, 64.76 feet to a point; thence, N86°36'38"E, 120.57 feet to the beginning of a curve; thence along the arc of a true curve to the right and having a radius of 320.00 feet, and the long chord of which bears S88°04'15"E, 59.32 feet, through a central angle of 10°38'14.5", 59.41 feet to a point of intersection with a tangent line; thence, S82°45'08"E, 465.35 feet to a point; thence, S76°39'41"E, 44.17 feet to the beginning of a curve; thence along the arc of a true curve to the right and having a radius of 50.00 feet, and the long chord of which bears S34°35'01"E, 67.01 feet, through a central angle of 84°09'21.0", 73.44 feet to a point of intersection with a tangent line; thence, S7°29'40"W, 170.99 feet to the beginning of a curve; thence along the arc of a true curve to the right and having a radius of 880.00 feet, and the long chord of which bears S19°28'09"W, 365.16 feet, through a central angle of 23°56'57.6", 367.84 feet to the beginning of a non-tangential curve; thence along the arc of a true curve to the left and having a radius of 826.93 feet, and the long chord of which bears N70°58'15"W, 600.23 feet, through a central angle of 42°33'37.1", 614.26 feet to said Point of Beginning and said Parcel being 8.13 acres, more or less, as set forth by "Exhibit A", attached and made a part hereof.



CASPER

RAWLINS

DEDICATED TO CLIENTS. DEFINED BY EXCELLENCE.

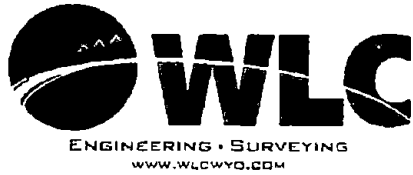

CASPER
200 PRONGHORN
CASPER, WY 82601
P: 307-266-2524

EXHIBIT "B"
Page 2 of 2

July 27, 2022

Casper Redevelopment Company, LLC
441 Landmark Drive, Suite 100
Casper, Wyoming 82609

W.O. No.: 17297-05

Description: Portion of Tract 4, North Platte River Park Subdivision – 6.37 Acres – West Lease Area

A Parcel located in and being a portion of Tract 4, North Platte River Park Subdivision, City of Casper, Natrona County, Wyoming, located in the SW1/4NW1/4, NW1/4SW1/4, Section 33, Township 34 North, Range 79 West, 6th P.M., being more particularly described by metes and bounds as follows:

Beginning at a point on the northerly line of the Parcel being described and from which point the W1/4 of corner of said Section 33 bears N.31°07'52"W., 320.38 feet, thence from said Point of Beginning, N.43°35'21"E., 275.88 feet to a point of curvature; thence 385.94 feet along the arc of a true curve to the right having a radius of 860.00 feet and through a central angle of 25°42'45" and the chord of which bears N.56°26'43"E., 382.71 feet to a point of tangency; thence N.69°18'06"E., 54.59 feet to a point of curvature; thence 82.96 feet along the arc of a true curve to the right having a radius of 50.00 feet and through a central angle of 95°04'03" and the chord of which bears S.63°09'53"E., 73.77 feet to a point of reverse curvature; thence 180.03 feet along the arc of a true curve to the left having a radius of 1133.00 feet and though a central angle of 9°06'15" and the chord of which bears S.20°10'58"E., 179.84 feet to a point of reverse curvature; thence 189.05 feet along the arc of a true curve to the right having a radius of 530.44 feet and through a central angle of 20°26'12" and the chord of which bears S.14°31'00"E., 188.20 feet to the southeast corner of the Parcel being described; thence 540.76 feet along the arc of a true curve to the left having a radius of 815.00 feet and through a central angle of 38°00'57" and the chord of which bears S.63°15'05"W., 530.89 feet to a point of tangency; thence S.44°14'36"W., 95.74 feet to a point; thence S.70°10'23"W., 106.75 feet to the southwest corner of the Parcel being described; thence 109.95 feet along the arc of a true curve to the right having a radius of 505.65 feet and through a central angle of 12°27'31" and the chord of which bears N.21°27'31"W., 109.73 feet to a point of reverse curvature; thence 129.83 feet along the arc of a true curve to the left having a radius of 478.00 feet and through a central angle of 15°33'46" and the chord of which bears N.23°00'38"W., 129.44 feet to a point of reverse curve; thence 97.36 feet along the arc of a true curve to the right having a radius of 75.00 feet and through a central angle of 74°22'52" and the chord of which bears N.6°23'55"E., 90.67 feet to said Point of Beginning and said Parcel being 6.37 acres, more or less, as set forth by "Exhibit A", attached and made a part hereof.



CASPER

RAWLINS

DEDICATED TO CLIENTS. DEFINED BY EXCELLENCE.

EXHIBIT C

Section 7.05 Construction Approvals by Landlord. Prior to commencing any excavation, construction, paving, or any other work associated with the Initial Construction, Tenant shall provide to Landlord for its approval five (5) sets of the preliminary design documents and the construction documents (the "**Plans**") in hard-copy format and 1 electronic version compatible with the City's latest version of Auto-Cad, fully identifying and describing the materials, signage, design, and **architectural 3-D renderings of the Facility.**

EXHIBIT D

CONSTRUCTION AGREEMENT

THIS SHALL BE FURNISHED TO THE LANDLORD UPON EXECUTION OF THE DOCUMENT BETWEEN THE TENANT AND ITS CONTRACTOR(S).





YOUTH SPORTS OUT WEST

WYO SPORTS RANCH

Welcome to Wyo Sports Ranch! A 131,000 square foot state of the art facility located in Casper, Wyoming. The scope... simple... Youth Sports Out West.

As a Division I basketball coach for over 30 years, I spent several weeks throughout a year traveling from coast-to-coast to recruit student-athletes participating in basketball tournaments. These tournaments ranged from hundreds of participants with thousands of family members cheering them on to events with thousands of participants with tens of thousands of family members. The opportunity for America's youth to showcase their talent, improve their skills or bond with teammates was ever-present and an exciting feeling. I am thrilled that finally Wyo Sports Ranch will provide a much-needed facility to provide these types of opportunities and exuberant emotions to student-athletes in the Rocky Mountain Region.

Author James P. Owen writes about the principal, Ride for the Brand, in his book, *Cowboy Ethics: What Wall Street Can Learn from the Code of the West*. He says a man's brand is his own special mark and when you ride for his brand you protect it like it your own. Well, at Wyo Sports Ranch, we are Riding for the Brand. Our team is focused, energetic and, most importantly, committed to creating an environment that benefits the future of our youth. Joining the team at Wyo Sports Ranch was an easy decision; now I ask you to come along with us as we truly Ride for the Brand.



Joe Legerski
Former Head Coach
Women's Basketball



MAKING A DIFFERENCE

Kids With Access to Sports Have Better Outcomes

Among the many ways that we can influence a child's life, few activities have the short and long-term impact of being involved in sports. According to a report by the National Parks & Recreation Association, adolescents who participate in after school activities, including sports, are 73 percent less likely to be arrested. Drug use is 51 percent less likely among this group. Numerous studies link physical activity with reduced risk of contracting 13 types of cancer, a reduced likelihood of obesity, and 40 percent higher test scores.

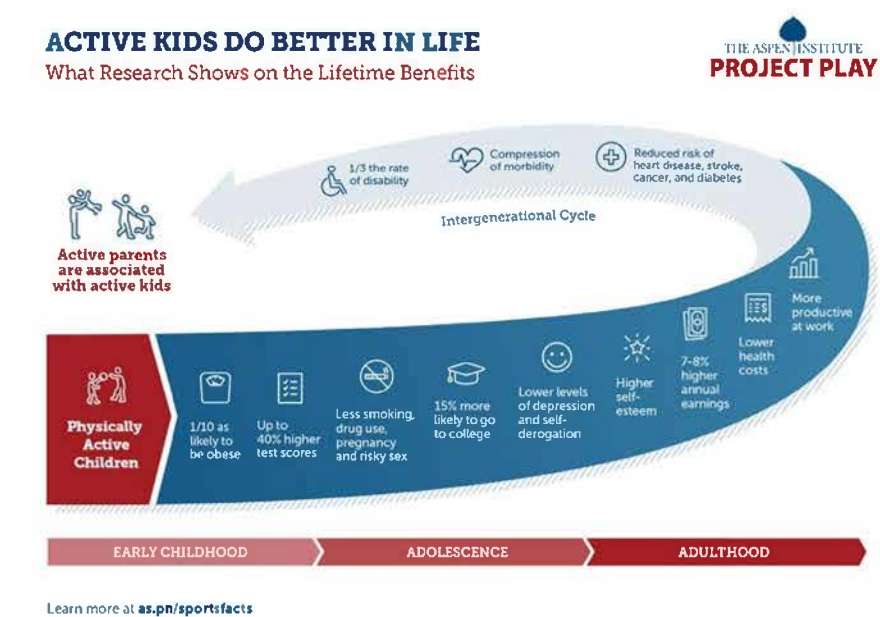

The Economic Impact of Sport

Whether you're in a small community or one of the nation's largest metropolitan areas, the sports industry has proven again and again to be one of the most powerful and consistent drivers of positive economic impact. According to a report from Sports ETA, the youth sports tourism industry generated a total economic impact of \$91.8 billion, supporting 635,000 full-time and part-time jobs and generating \$12.9 billion in taxes in 2021. The industry has also been a powerful force for raising the overall profile of smaller municipalities. Cities such as Elizabethtown, KY and Hoover, AL—both a similar size to Casper, WY—have established reputations for hosting some of the nation's most popular youth and amateur sports events.

More Opportunity for Kids

Wyo Sports Ranch will offer programming opportunities to kids as young as 18 months through seniors. Every age group, ability, and ambition to play will have an opportunity to play and participate at Wyo Sports Ranch.

At maturity, Wyo Sports Ranch is estimated to host 24 events per year, ranging from 24-160 teams per event. That means 1,240 teams — equating to 789,000 athletes — from across the Rocky Mountain Region will visit Wyo Sports Ranch each year.

Locally, approximately 25,000 youth in Central Wyoming will have the opportunity to participate programming like leagues, camps, clinics, and club teams at Wyo Sports Ranch. This facility is sure to transform youth athletics and activities in Wyoming and the Rocky Mountain region.

THE BEGINNINGS

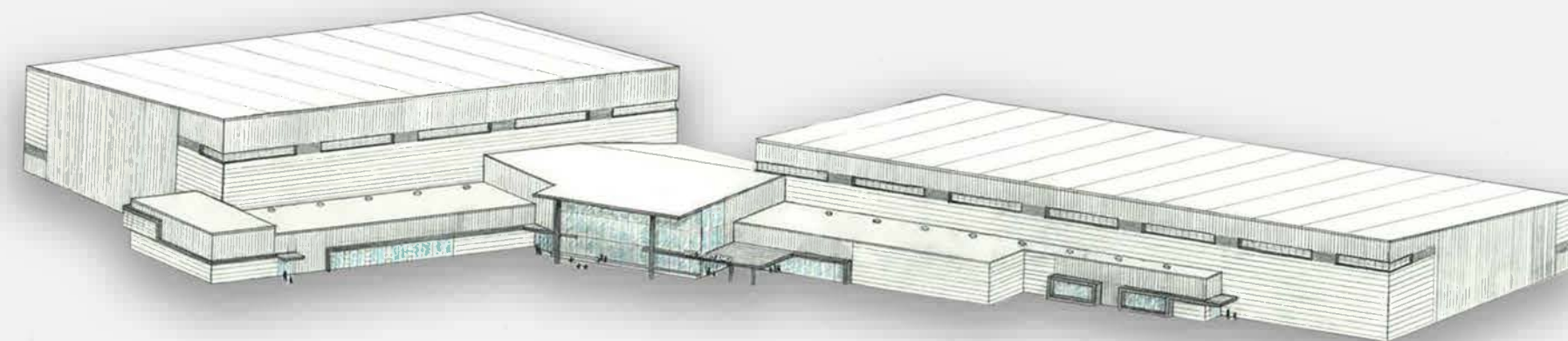

Our Mission

To provide Wyoming and the surrounding community a unique, state-of-the-art facility for competition, training, and special events, while emphasizing the importance of physical and mental health in our youth and promoting an active lifestyle for our guests.

Vision

Wyo Sports Ranch is a multi-sport training, recreation, events, and entertainment facility that will serve as a hub for a variety of sports as well as many other recreation and community pursuits. The facility will provide an atmosphere of community for sports clubs, event organizers, and participants. The facility will focus on five principle offerings:

- Youth sports training programs, clinics, and camps
- Sports performance and fitness training
- Youth and adult leagues, tournaments, and events
- Family-friendly entertainment and events
- Facility rental for corporate meetings and social gathering events



THE FACILITY

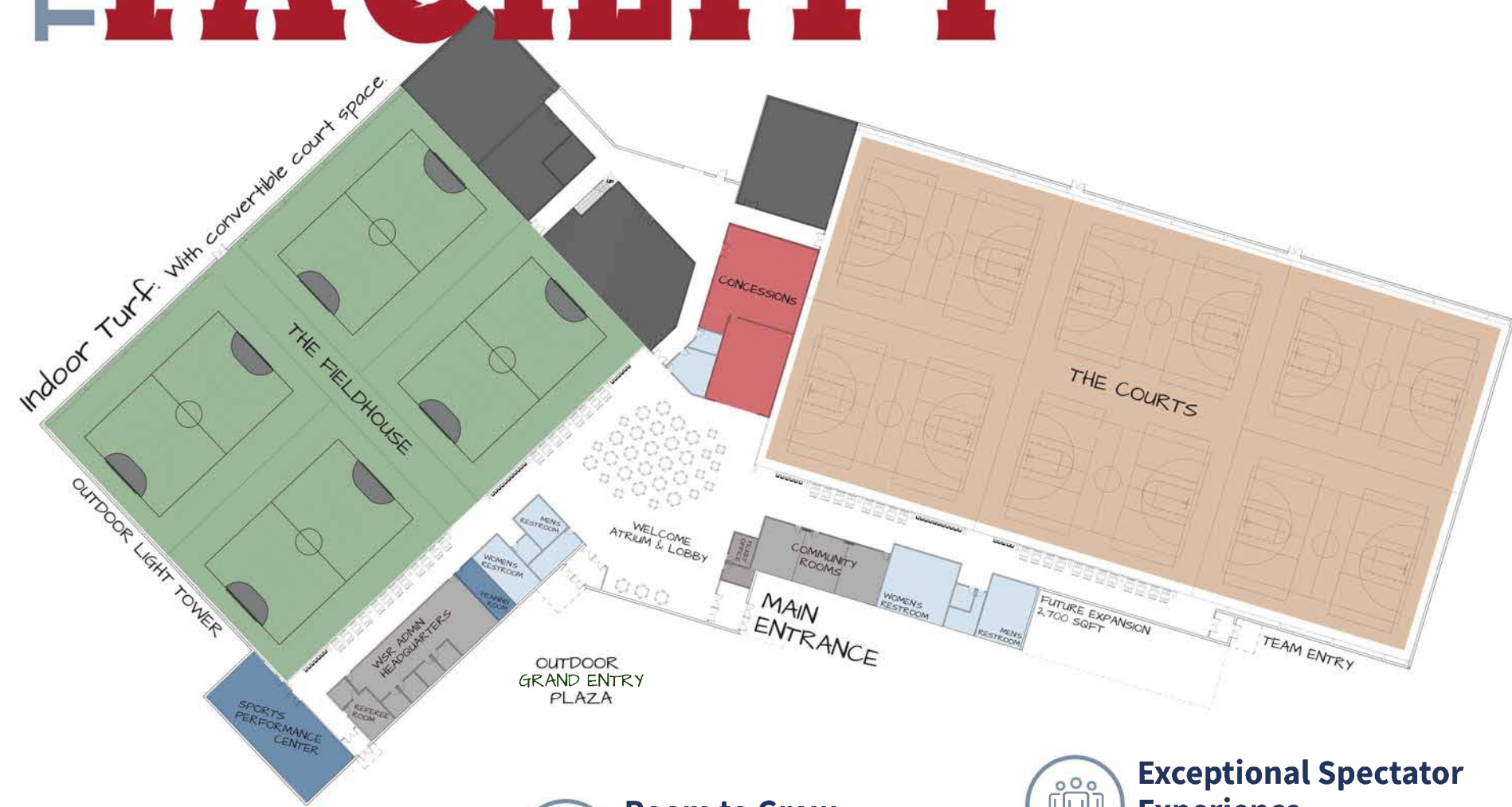

Quality Surfaces

Playing surfaces make all the difference. Our court space, both hardwood and turf, will be of the highest quality to help our athletes perform at the highest levels.



Room to Grow

Our multi-use facility has endless opportunities to accommodate the needs of a multitude of sports and events. From everyday practice to large regional tournaments, there's space for all who come to play out west.



Exceptional Spectator Experience

Our facility will offer an exceptional spectator experience for guests. Top-of-the-line amenities like full-service concessions, lounge areas, Wi-Fi, and ample spectator seating for each court will make Wyo Sports Ranch the premier facility in the region for game day enjoyment.



10 Basketball Courts

- 6 permanent basketball courts
- 4 additional temporary courts

20 Volleyball Courts

- 12 permanent volleyball courts
- 8 additional temporary courts

Permanent Indoor Multi-Use Turf

Sports Performance & Training

Opportunities For:

- Mat Sports
- Dance/Cheer
- Pickleball
- Baseball/Softball
- Events/Trade Shows
- Other entertainment opportunities to support our mission



CONCEPT TO CONCRETE

THE SPORTS FACILITIES COMPANIES

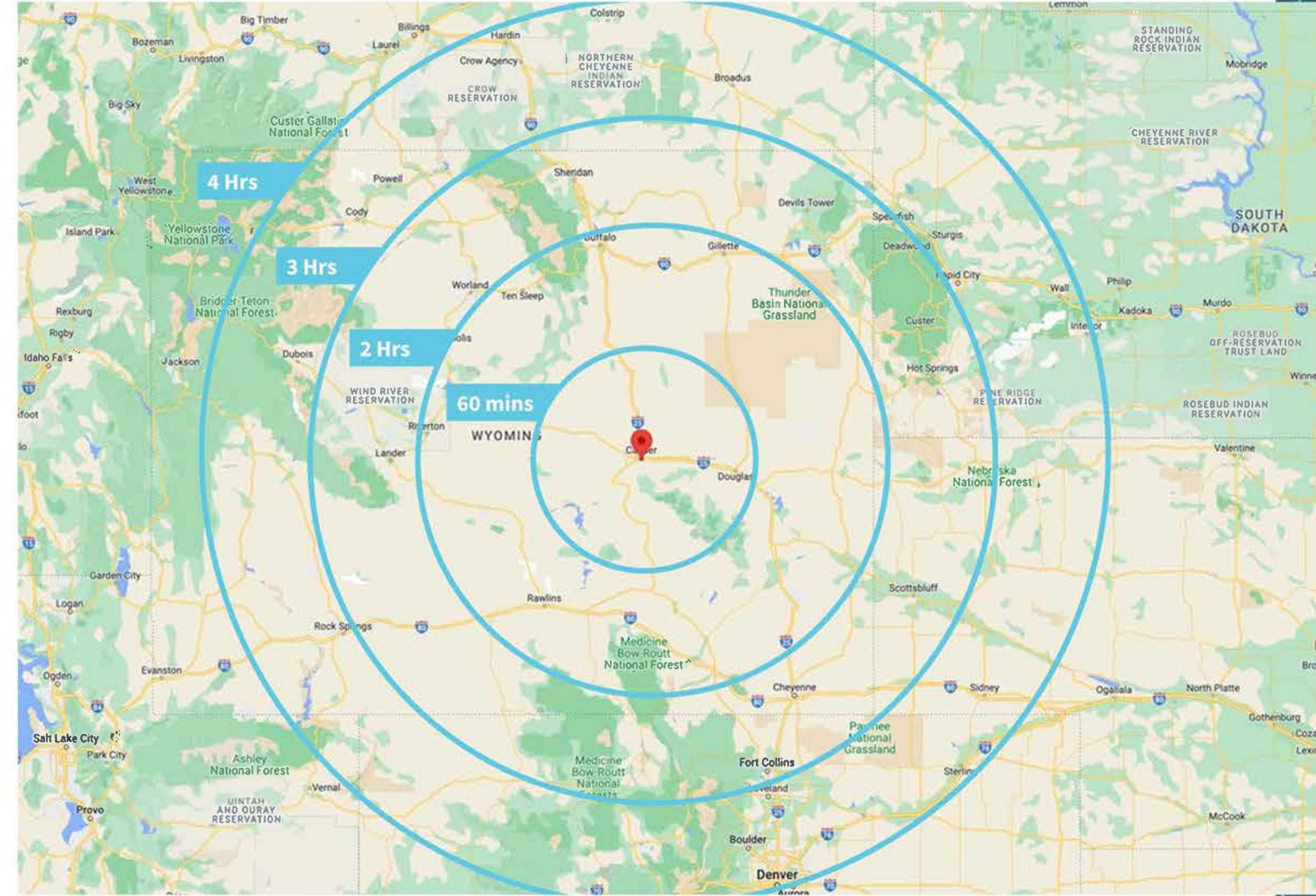
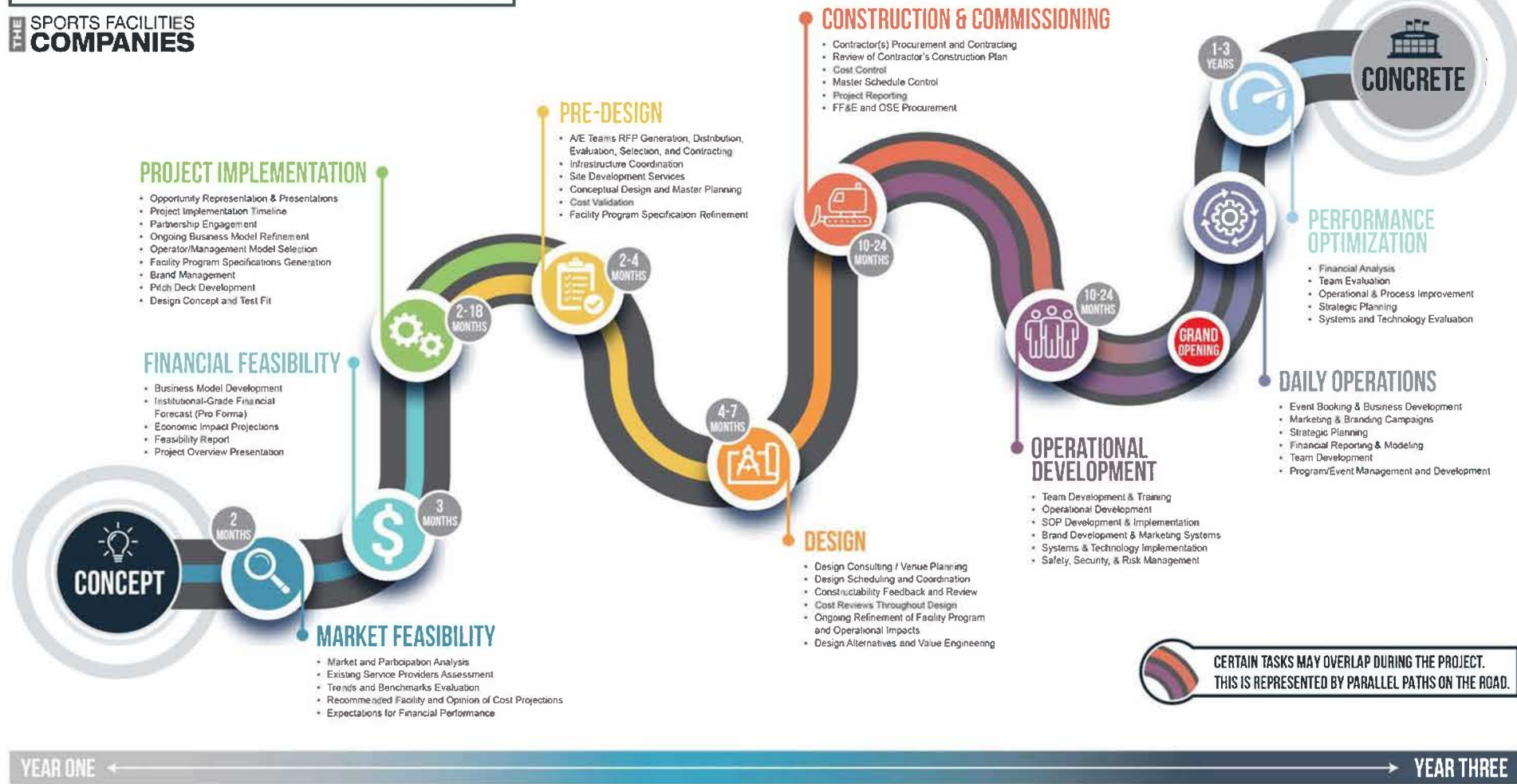

25,000 YOUTH
in a 90-minute drive

789,000 YOUTH
in a four-hour drive

\$39 million
in total project costs

Opening **SUMMER 2024**

REGIONAL REACH

Wyo Sports Ranch will be a game-changer in the youth sports industry as the only facility of this size and stature in the Rocky Mountain Region. With its location in Casper, WY, Wyo Sports Ranch will be a centrally-located hub for Youth Sports Out West.

Centrally-located between Billings, MT, Rapid City, SD, and Denver, CO, Casper can reach an estimated 789,000 are youth, in a short 4-hour drive.

THE OPPORTUNITY

CHANGE LIVES FOR GENERATIONS TO COME

Wyo Sports Ranch began as a simple vision wanting to change the athletic atmosphere and opportunities for youth in our local community.

Today, that vision has grown to become a one-of-a-kind reality for Youth Sports Out West. Wyo Sports Ranch will be a remarkable facility that transformations youth athletics and activities in Wyoming and the Rocky Mountains. There will be nothing like it in our region. It will draw athletes to Wyoming to compete at a high level, across a variety of sports, all year round.

We are building a unique, state-of-the-art facility for competition, training, and events that promotes a healthy lifestyle for our youth. Whether they go “all the way” to play college and professional athletics or simply learn to live more active lifestyles as adults, Wyo Sports Ranch, and the sports played within its walls, will be key in fostering the future of our youth.

The benefits of this project reach far and wide from the mental and physical health of our youth to the grand economic impact it will have in Central Wyoming. It is an exciting project, and we invite you to join us on this ride. Let's bring Youth Sports Out West and change lives for generations to come.

“The McMurry Foundation is excited and fortunate to support such an amazing facility in the heart of Wyoming. The Wyo Sports Ranch will be the place where youth sports teams, parents, coaches, philanthropists, and visionaries come together to offer Wyoming and region an amazing place to play and grow in their athletic experiences. Building better opportunities for our youth and doing it the Wyoming way is the McMurry Foundation’s focus for this project. We are proud to support this vision. A vision that will only be achieved through partnerships. What an opportunity...to shape the future of the kids in our communities by promoting fun, fitness, competition, and healthy lifestyles.”

*Trudi Holthouse
Director of the McMurry Foundation*



BEN BLALOCK

307.760.4738
info@wyosportsranch.com

wyosportsranch.com



IT'S ABOUT OUR YOUTH



**PARTNER WITH US TO BUILD
A BRIGHT FUTURE OUT WEST**





wyosportsranch.com

RESOLUTION NO. 22-183

A RESOLUTION AUTHORIZING A GROUND LEASE AGREEMENT BETWEEN THE CITY OF CASPER AND WYO COMPLEX, A WYOMING NON-PROFIT CORPORATION.

WHEREAS, the City of Casper was approached by WYO Complex, a non-profit entity that desires to construct an indoor sports and events complex in close proximity to the Ford Wyoming Center; and,

WHEREAS, the land that WYO Complex proposes to construct their facility on is City-owned. Leasing the property to WYO Complex for the purpose of constructing a facility for sports and educational activities will further community and economic development of the City of Casper and the surrounding communities; and,

WHEREAS, the lease of the land to construct the facility would: (1) increase the number of visitors to the City, bringing the revenue associated therewith; (2) allow large regional tournaments and educational events to be hosted in Casper; (3) increase the availability of court and turf space for youth sports which boosts the physical and mental health of the communities' youth; and (4) create a space and entity for coordination of events with the Ford Wyoming Center to draw more events to the City; and,

WHEREAS, the anticipated construction costs for WYO Complex are in the tens of millions of dollars; and,

WHEREAS, the parties desire to enter into a Ground Lease Agreement under the terms and conditions delineated in the Ground Lease Agreement.

NOW, THEREFORE, BE IT RESOLVED BY THE GOVERNING BODY OF THE CITY OF CASPER, WYOMING: that the Mayor is hereby authorized to execute, and the City Clerk to attest a Ground Lease Agreement between the City of Casper and WYO Complex.

PASSED, APPROVED, AND ADOPTED this ____ day of October 2022.

APPROVED AS TO FORM:

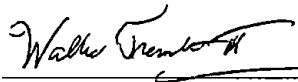

ATTEST:

Fleur Tremel
City Clerk

CITY OF CASPER, WYOMING
A Municipal Corporation

Ray Pacheco
Mayor

September 26, 2022

MEMO TO: J. Carter Napier, City Manager *JCN*

FROM: Andrew Beamer, P.E., Public Services Director
Alex Sveda, P.E., City Engineer *AS*

SUBJECT: Authorizing a Right-of-Way Easement with Rocky Mountain Power as part of the Natrona County School District Tennis Facility.

Meeting Type & Date:
Regular Council Meeting
October 4, 2022

Action Type:
Resolution

Recommendation:
That Council, by resolution, authorize a right-of-way easement with Rocky Mountain Power, as part of the Natrona County School District Tennis Facility.

Summary:
The Natrona County School District (NCSD) has begun work for the new Tennis Facility located near Highland Park. The NCSD has requested to vacate the existing Rocky Mountain Power (RMP) primary service to the Aquatics Center and make a new primary service to the Aquatic Center that will connect power near the Ice Arena chiller building. This will eliminate the existing RMP primary service that runs under the proposed tennis courts.

This work will require a new and a 15-foot wide, 371.8-foot long right-of-way utility easement with Rocky Mountain Power. The easement is across city property.

Financial Considerations
None

Oversight/Project Responsibility
Alex Sveda, Associate Engineer

Attachments
Resolution
Right-Of-Way Easement (two (2) copies)
Exhibit "A"
Exhibit "B"

REV101512
Return to:
Rocky Mountain Power
Estimating Department
2840 E. Yellowstone Hwy.
Casper, WY 82609

Project Name: CAS:5H152:1841 E 4TH ST 3379/108683 ACC
WO#: 08129440
RW#:

UNDERGROUND RIGHT OF WAY EASEMENT

For value received, **City of Casper** ("Grantor"), hereby grants to PacifiCorp, an Oregon Corporation, d/b/a Rocky Mountain Power its successors and assigns, ("Grantee"), an easement for a right of way **15 feet** in width and **371.8 feet** in length, more or less, for the construction, reconstruction, operation, maintenance, repair, replacement, enlargement, and removal of underground electric power transmission, distribution and communication lines and all necessary or desirable accessories and appurtenances thereto, including without limitation: wires, fibers, cables and other conductors and conduits therefor; and pads, transformers, switches, cabinets, and vaults on, across, or under the surface of the real property of Grantor in **Natrona County, State of Wyoming** more particularly described as follows and as more particularly described and/or shown on Exhibit(s) **A & B** attached hereto and by this reference made a part hereof:

Legal Description SE1/4NE1/4, Section 10, Township 33 North, Range 79 West of the 6th Principal Meridian

Assessor Parcel No. 33791010000100

Together with the right of reasonable access to the right of way from adjacent lands of Grantor for all activities in connection with the purposes for which this easement has been granted; and together with the present and (without payment therefor) the future right to keep the right of way clear of all brush, trees, timber, structures, buildings and other hazards which might endanger Grantee's facilities or impede Grantee's activities.

Grantor hereby reserves, and shall have the right to use the right of way granted herein for any use which does not otherwise unreasonably interfere with the Grantee's use thereof, including the right to install walkways, trails, or sidewalks, or other public or private utilities on or in the easement property.

Grantee shall restore all areas disturbed for the purpose of the electrical system on the easement property to preexisting conditions following maintenance activities.

This easement shall terminate and be of no further force or effect upon the grantee ceasing to use the easement granted herein for a period of 12 consecutive months for its use for the electrical system described herein.

The rights and obligations of the parties hereto shall be binding upon and shall benefit their respective heirs, successors and assigns.

Dated this _____ day of _____, 2022.

APPROVED AS TO FORM:

Wallue Tremel

City Attorney (Deputy)

ATTEST:

CITY OF CASPER, WYOMING
A Municipal Corporation

By: _____

Fleur Tremel
City Clerk

Ray Pacheco
Mayor

STATE OF WYOMING
COUNTY of NATRONA

This instrument was acknowledged before me on this _____ day of _____,
2022 by Ray Pacheco, as the Mayor of the City of Casper, Wyoming, a Wyoming Municipal Corporation.

(notary signature)

NOTARY PUBLIC FOR _____ (state)
Residing at: _____ (city, state)
My Commission Expires: _____

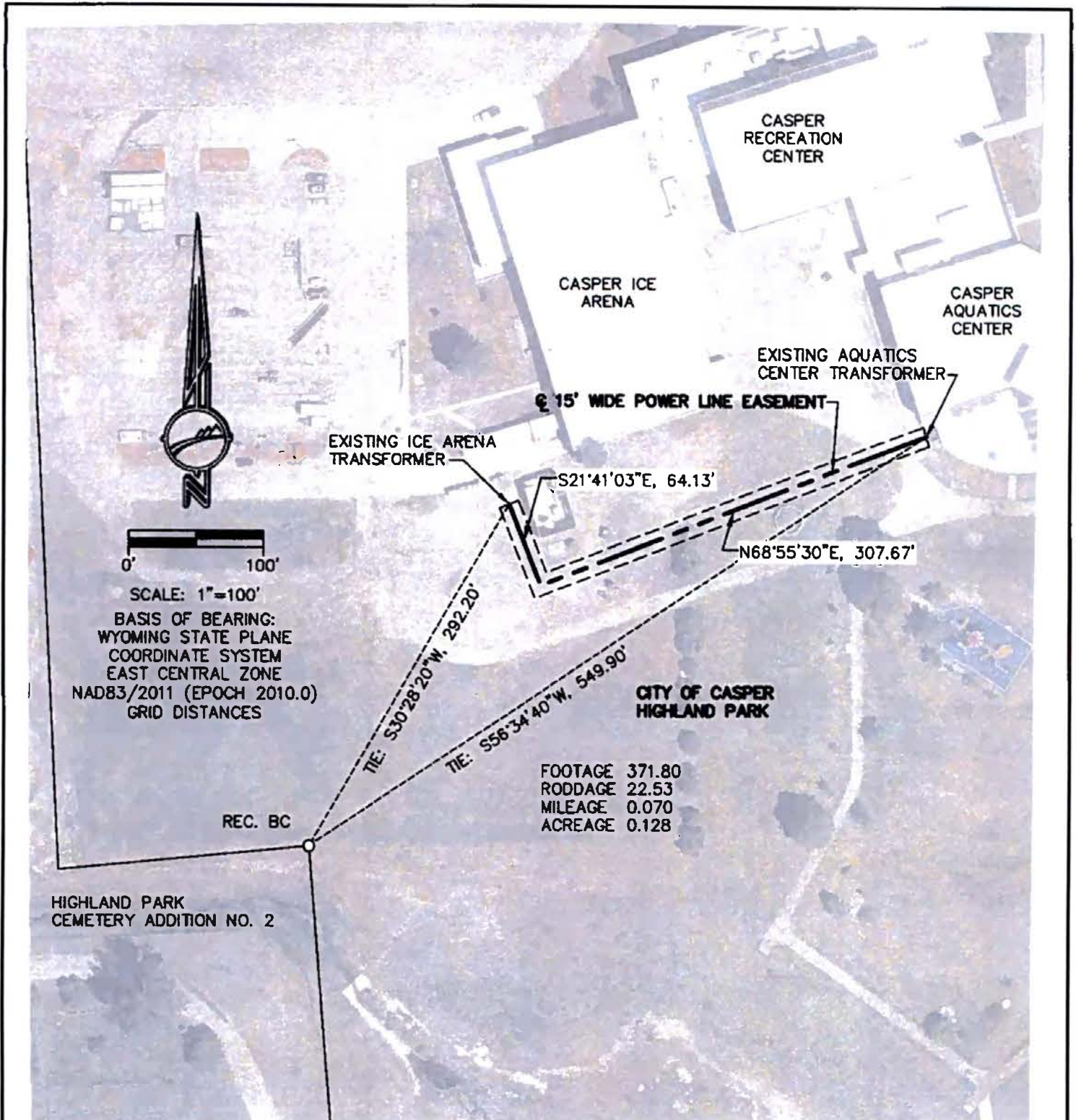

**POWER LINE EASEMENT LOCATED IN THE SE1/4NE1/4, SECTION 10,
T.33N., R.79W., 6TH P.M., NATRONA COUNTY, WYOMING**

NOTES:
THIS DRAWING SHOULD BE USED ONLY AS A REPRESENTATION OF THE LOCATION OF THE EASEMENT BEING CONVEYED. THE EXACT LOCATION OF ALL STRUCTURES, LINES AND APPURTENANCES IS SUBJECT TO CHANGE WITHIN THE BOUNDARIES OF THE RIGHT OF WAY HEREIN GRANTED.

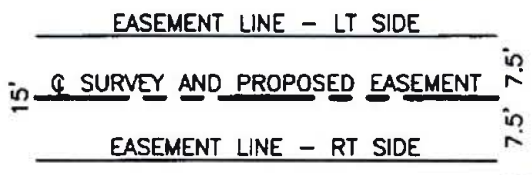

CERTIFICATE OF SURVEYOR
STATE OF WYOMING }
COUNTY OF NATRONA } ss

PAUL R. SVENSON HEREBY STATES THAT HE IS BY OCCUPATION A PROFESSIONAL LAND SURVEYOR, EMPLOYED BY GSG ARCHITECTURE TO MAKE THE SURVEY OF A POWER LINE EASEMENT DESCRIBED AND SHOWN ON THIS MAP; THAT THE SURVEY OF SAID WORKS WAS MADE UNDER HIS SUPERVISION DURING THE MONTH OF AUGUST 2022; AND THAT SUCH SURVEY IS ACCURATELY REPRESENTED ON THIS MAP.



WO#17423

EXHIBIT "A"

REV	DATE	DESC.	BY	CHK	APP
0	8-23-2022	REC CENTER POWER EASEMENT.DWG	JLS	PRS	
1	9-26-2022	REVISE EASEMENT WIDTH	JLS	PRS	



POWER LINE EASEMENT ON
CITY OF CASPER LANDS

LOCATED IN THE SE1/4NE1/4, SECTION 10, T.33N., R.79W.,
6TH P.M., NATRONA COUNTY, WYOMING

SHEET 1 OF 1
AQUATICS CENTER

SCALE 1"=100'
REV. 1

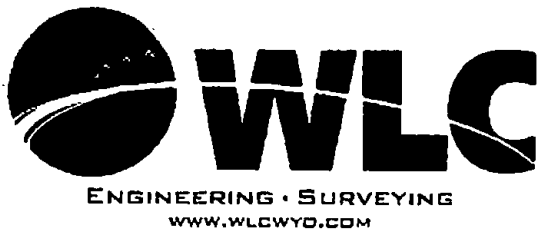

CASPER
200 PRONGHORN
CASPER, WY 82601
P: 307-266-2524

Exhibit "B"

Page 1 of 1

September 26, 2022, REV1
August 23, 2022

GSG Architecture
1042 So. David Street
Casper, Wyoming 82601

W.O. No.: 17423

Description: 15' Wide Power Line Easement- Casper Aquatics Center

A Parcel and Strip being 15 feet in width located in and being a portion of the SE1/4NE1/4, Section 10, Township 33 North, Range 79 West of the 6th Principal Meridian, Natrona County, Wyoming lying 7.5 feet parallel and perpendicular to each side of the centerline being more particularly described as follows:

Beginning at the westerly most end of the centerline being described and a point at the south side of and existing power transformer and from which point an angle point in the east line of the Highland Park Cemetery No. 2 Addition bears S.30°28'20"W., 292.20 feet; thence along the centerline being described, S.21°41'03"E., 64.13 feet to a point; thence N.68°55'30"E., 307.67 feet to the easterly most end of the centerline being described and a point at the west side of an existing power transformer and from which point an angle point in the east line of the Highland Park Cemetery No. 2 Addition bears S.56°34'40"W., 549.90 feet, and said Parcel and Strip being 0.128 acres, more or less, as set forth by the Exhibit "A" attached and made a part hereof.



CASPER

RAWLINS

DEDICATED TO CLIENTS. DEFINED BY EXCELLENCE.

RESOLUTION NO. 22-184

A RESOLUTION AUTHORIZING A RIGHT-OF-WAY EASEMENT WITH ROCKY MOUNTAIN POWER FOR NATRONA COUNTY SCHOOL DISTRICT TENNIS FACILITY.

WHEREAS, the Natrona County School District has begun work for the new Tennis Facility located near Highland Park and has requested to relocate the Rocky Mountain Power primary service to the Aquatics Center; and,

WHEREAS, authorizing of a Right-of-Way Easement with Rocky Mountain Power will allow the work to be constructed.

NOW, THEREFORE, BE IT RESOLVED BY THE GOVERNING BODY OF THE CITY OF CASPER, WYOMING: That the Mayor is hereby authorized and directed to execute, and the City Clerk to attest, an underground Right-of-Way Easement with Rocky Mountain Power.

PASSED, APPROVED, AND ADOPTED this ____ day of _____, 2022.

APPROVED AS TO FORM:



ATTEST:

CITY OF CASPER, WYOMING
A Municipal Corporation

Fleur D. Tremel
City Clerk

Ray Pacheco
Mayor

September 27, 2022

MEMO TO: J. Carter Napier, City Manager *JCN*
FROM: Keith McPheeters, Police Chief *KMcP-307*
SUBJECT: Authorizing the purchase of one (1) Lenco BearCat in the amount of (\$168,872.00)

Meeting Type & Date

Regular Council Session
October 4, 2022

Action type

Minute Action

Recommendation

That Council, by minute action, approve the purchase of an armored tactical rescue vehicle. Specifically, the Department is seeking Council's approval to purchase of a certified, preowned Lenco BearCat G2 Incident Response Vehicle. The vehicle is currently quoted at \$168,872.00 (One Hundred Sixty-eight Thousand Eight Hundred and Seventy-two and 00/100). Please see the attached manufacturer's quote and specifications sheet for details.

Summary

The Casper Police Department's mission includes resolution of critical incidents including, active shooter response, terrorist attacks, improvised explosive devices (IEDs), Hazardous Materials (HAZMAT) and CBRNE Chemical, Biological, Radiological, Nuclear, and Explosives (CBRNE) incidents. The department is also tasked with providing support for Search and Rescue operations and response to natural disaster situations.

The BearCat is a four-wheel drive vehicle that can reach highway speeds for rapid ingress/ egress to affected areas. The vehicle features 40-inch-tall, heavy-duty, run-flat tires and heavy-duty drivetrain components. A modular, electric-powered winch provides the capability to remove debris blocking emergency ingress/egress and a rear tow hitch with a 10,000-pound towing capacity that provides the capability to pull trapped automobiles out of danger or to deliver towable assets. These combined features greatly increase the overall capability to quickly respond in all environmental conditions throughout our entire jurisdiction from the most remote rural areas to the city streets of Casper, in conditions ranging from severe winter storms to the immediate aftermath of tornados or earthquakes.

The BearCat is designed to seat 12 Search and Rescue personnel with equipment or 20 citizens for evacuation or transportation operations.

Along with the rugged vehicle design noted above and the increased capability to access areas compromised by disaster, the BearCat features roof mounted, high-intensity spotlights for use in search and rescue operations. The BearCat's 2000 WATT AC/DC power inverter, combined with the turbo diesel engine, turns the vehicle into a mobile generator, providing power for portable rescue or extrication equipment.

The BearCat's hardened walls and windows provide ballistic and blast protection capable of defeating the small arms projectiles and IEDs historically used in most domestic terrorist attacks. The vehicle provides

room for up to 12 officers in full response gear. Ballistic skip round shields below the undercarriage prevent bullets or fragmentation from traveling underneath the vehicle during terrorist incidents thus increasing the ballistic protection and “surface area” of protection while shielding citizens or responders.

The BearCat is built on a Ford F550 Super Duty chassis. This enables the vehicle to be serviced, maintained and repaired utilizing the personnel and facilities currently available within the community and in use for our fleet management. The maintenance costs of this project will be absorbed into the established fleet maintenance budget of the Casper Police Department.

Lenco products, including the BearCat, are widely used and proven throughout the world, with over 750 federal, state and local agencies in all 50 states and three US territories. Lenco is a GSA contract vendor. Supporting documentation is attached.

The project cost includes the manufacturer’s operations training and maintenance manuals. The Casper Police Department will establish Policy and Procedures with protocol for training, deployment, supervision and maintenance of specialized equipment. The established department training plan will accommodate the necessary initial and continued training on the BearCat. There are no additional training costs associated with this project.

It is the recommendation of the Casper Police Department that the City Council authorize the purchase of a Lenco BearCat.

Financial Considerations

Funding for this project may be provided by the Opportunity Fund.

Oversight/Project Responsibility

Keith McPheeters, Chief of Police

Attachments

- Lenco Cooperative Purchasing Contracts
- Lenco BearCat G2 Flier
- Lenco BearCat Quotation



Protecting Our Nation's Defenders™

US Government Cooperative Purchasing Contracts

1. GSA Federal Acquisition Service – Multiple Award Schedule

Contract Number: GS-07F-169DA
Current Option Period End Date: August 22, 2026

Important Links:

- [Lenco GSA eLibrary Link](#)
- [1122 Participating States](#)

2. H-GAC – Ambulances, EMS, and Other Special Service Vehicles

Contract Number: AM10-20
Current Option Period End Date: September 30, 2022

Important Links:

- [HGACBuy Contract Link](#)

3. North Carolina Sheriff's Association (NCSA) – Fire and EMS 2021 – 2022

Contract Number: 21-01-0608R and 22-02-0608
Current Option Period End Date: June 17, 2022

Important Links:

- [NCSA Contract Award Documents Link](#)

4. US Communities (OMNIA Partners) – Public Safety & Emergency Preparedness

Contract Number: 4400008468
Current Option Period End Date: September 30, 2023
Lead Agency: County of Fairfax, Virginia
Lead Contractor: Safeware, Inc. and Mallory Safety and Supply, LLC

Important Links:

- [US Communities / OMNIA Partners Contract Link](#)

5. New Jersey Cooperative Purchasing Alliance (Bergen County Co-Op) – Catalog / SWAT Equipment

Contract Number: BC-Bid-#21-55 (COOP)
Current Option Period End Date: December 3, 2023
Lead Agency: County of Bergen, NJ
Lead Contractors: Tomahawk Strategic Solutions

Important Links:

- [Bergen County Co-Op Contract Link](#)

Designer and Manufacturer of Tactical Armored Security Vehicles

10 Betnr Industrial Drive · Pittsfield, MA 01201 · Tel (413) 443-7359 · Fax (413) 445-7865

www.LencoArmor.com · e-mail: Info@LencoArmor.com

6. Howard County, MD Office of Procurement and Contract Administration – New Vehicles, Class 1 – 7

Contract Number: 4400003205

Current Option Period End Date: June 30, 2022

Important Links:

- [Howard County, MD Current Awards and Contracts Link](#)
- [Current Contracts Link](#)

Last updated March 30, 2022

Designer and Manufacturer of Tactical Armored Security Vehicles

10 Betnr Industrial Drive · Pittsfield, MA 01201 · Tel (413) 443-7359 · Fax (413) 445-7865

www.LencoArmor.com · e-mail: Info@LencoArmor.com

\$169,725 OBO

WWW.LENCOARMOR.COM

BEARCAT G2



2006 Lenco BEARCAT CERTIFIED PREOWNED

SPECIFICATIONS:

- On-Road & Urban Tactics
- Hydraulic RAM BAR
- .50 Cal Armor Rating / NIJ IV
- 4-Wheel Drive
- Seating for (8-10)
- Blast Resistant Floor Material
- Adjustable Height Gunner Stand
- 40 Gallon Armored Fuel Tank
- Rotating Roof Hatch
- 200-Watt Siren & PA System
- One Piece Side Walls
- Fully Aromored Hood

Images may not depict actual condition or options.
Normal wear and tear including some paint blemishes.



LENCO
ARMORED ★ VEHICLES





Protecting Our Nation's Defenders™

10 Betnr Industrial Drive – Pittsfield, MA 01201
 PH (413) 443-7359 – FAX (413) 445-7865

Quotation: 22715B

Customer Code: CALWY
 Quotation Date: 8/25/2022
 Lenco Tax ID#: 04-2719777
 Repeat Customer: Yes No

Bill To

Casper Police Department
 201 N. David
 Casper, WY 82601

Ship To

Casper Police Department
 201 N. David
 Casper, WY 82601

Payment Terms	Shipping Terms	Ship Via
Net 30 Days	FOB: Destination	Common Carrier
Estimated Completion	Inhouse Contact	Inspection & Acceptance
12+ Months ARO (Est)	Jim Massery	At Lenco's Facility in Pittsfield, MA

Item:	Product #	Qty	Unit Price	Extension
Lenco BearCat	BC55003	1	\$ 169,725.00	\$ 169,725.00
Paint Color Lusterless Navy Blue	18-F93XXL7508			
LED Lights Red & Blue				
<u>Options:</u>				
Rear A/C Heating-Heating System: High Capacity	UBCHAC	1		\$ -
Hydraulic Front Mounted Receiver with Ram Post and Plate	UBCHYDRAM	1		\$ -
Backup Camera System with Monitor	UBCBU	1		\$ -
Gas Injector Unit	UBCGIU	1	\$ 14,552.00	\$ 14,552.00
Ballistic Skip Round Shield	BCBSRS	2	\$ 1,936.00	\$ 3,872.00
BearCat (Configuration Subtotal)		1	\$ 188,149.00	\$ 188,149.00
Discount	TID	1	\$ (19,277.00)	\$ (19,277.00)

Notes: Preowned Lenco BearCat G2 - 2006 Stock #4119U (Subject to Availability) Discount - Per Agency's best offer.	Proprietary	
	Subtotal	\$ 168,872.00
	Shipping	\$ 9,300.00
	Tax	\$ -
	Total Order	\$ 178,172.00

WARNING: Information Subject to Export Control Laws
 The written approval of the Directorate of US Defense Trade Controls and Lenco Industries, Inc must be obtained before reselling, transferring, transshipping or disposing of a defense article to any end user, end use or destination other than as stated on this Lenco quote or the shipper's export declaration in cases where an exemption is claimed under this subchapter ITAR 123 9(A)

Acceptance of this quotation or entering into a purchase agreement with Lenco, the purchaser agrees to Lenco's full Terms and Conditions of Sale, available upon request. This quote will be valid for 90 days

ACCEPTANCE OF PROPOSAL -

Authorized Signature:  307
 Please Sign and Return

Authorized Signature: 
 Jim Massery

Thank You

October 4, 2022

MEMO TO: His Honor the Mayor and Members of the Casper City Council
FROM: J. Carter Napier, City Manager 
SUBJECT: Councilmember Appointments to City Boards and Commissions

Meeting Type & Date

Regular Council Meeting, October 4, 2022

Action Type

Minute Action

Recommendation:

That Council, by minute action, authorize Mayor Pacheco's appointments to the Council Boards and Commissions listed on the attachment to fill vacancies left by Councilmembers' resignations.

Summary:

The Casper City Council has various volunteer boards and commissions that operate per their directive. The boards and commissions are a vital link of communication between citizens and the City Council, City departments, and City administration. These bodies provide experience and knowledge that help the City Council and administrative departments make wise decisions.

Councilmember Shawn Johnson resigned his Council seat effective August 22, 2022, and Councilmember Steve Freel resigned his effective August 31, 2022. These resignations created open seats on the boards and commissions on which they served. Mayor Pacheco has collaborated with the other Councilmembers to fill the vacancies left by these resignations.

It is recommended that Council approve these appointments made by Mayor Pacheco as listed on the attachment. The appointments will be for the remainder of the initial terms.

Financial Considerations

There are no financial considerations with this action.

Oversight/Project Responsibility

Mayor Ray Pacheco

Attachments

October 2022 Council Boards and Commissions Appointments

**COUNCIL BOARDS AND COMMISSIONS APPOINTMENTS
OCTOBER 2022**

	Name of Board or Commission	Previous Councilmember	Councilmember Appointed
1.	Advance Casper (CAEDA)	Steve Freel	Carter Napier *
2.	Casper-Natrona County Health Department	Steve Freel	Kenyne Humphrey
3.	Central Wyoming Regional Water System JPB	Steve Freel	Amber Pollock
4.	College National Finals Rodeo	Steve Freel	Steve Cathey as the board member, Bruce Knell, as the alternate.
5	Council Finance Committee	Shawn Johnson	Lisa Engebretsen
6.	LGBTQ Committee	Steve Freel	Amber Pollock
7.	Natrona County Council of Governments	Steve Freel	Bruce Knell
8.	Old Yellowstone District (OYD) Advisory Committee	Steve Freel	Kyle Gamroth
9.	Public Safety Communications Center	Steve Freel	Ray Pacheco
10.	Travel and Tourism (Visit Casper)	Steve Freel	Lisa Engebretsen, Bruce Knell remains as alternate.

* City Manager Carter Napier has been assigned to serve with Councilmember Kyle Gamroth, who was appointed at the beginning of 2022.